

HITACHI

Inspire the Next

Instruction Manual



DZ-GX20A
DZ-MV780A/DZ-MV730A

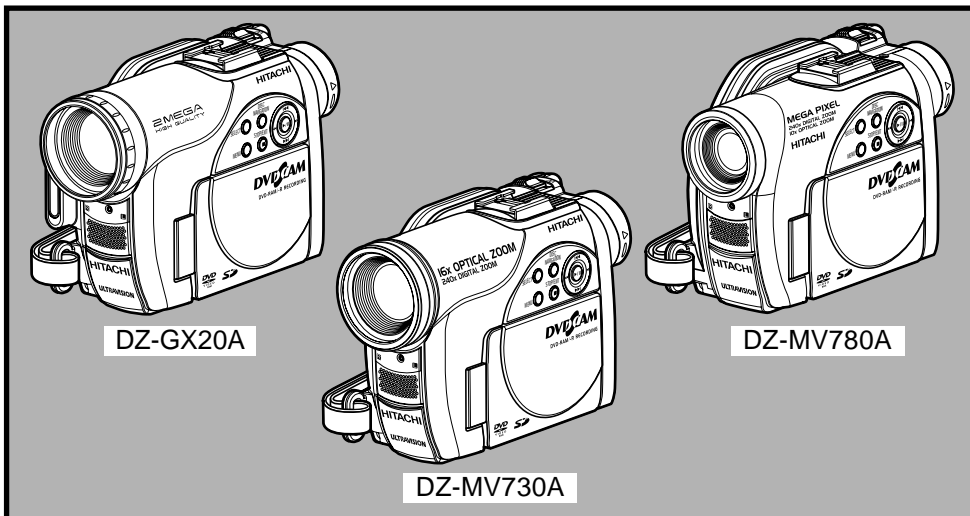

HITACHI AMERICA, LTD. HOME ELECTRONICS DIVISION

900 Hitachi Way
Chula Vista, CA 91914-3556
Service Hotline: 1-800-HITACHI
(1-800-448-2244)

HITACHI CANADA LTD. DIGITAL MEDIA DIVISION

2495 Meadowpine Blvd.
Mississauga, Ontario L5N 6C3
CANADA
Service Direct: 1-800-HITACHI
(1-800-448-2244)

DVDCAM PC Software Support Center

URL <http://dvdcam-pc.support.hitachi.ca/>

Thank you for buying a Hitachi product. Please take time to become familiar with the manual and how it is set up. Keep it handy for future reference.

Be sure to read page 181 before unpacking the provided CD-ROM.

The illustrations of DZ-MV780A and DZ-MV730A are shown only on the front cover of this instruction manual.

The method for operating the DZ-MV780A and DZ-MV730A is the same as that for DZ-GX20A.

QR35602 ©Hitachi, Ltd. 2005



This manual was printed with soy based ink.

Printed on recycled paper

Printed in Japan OG-H(1)

Important Information

For Your Safety

The power switch turns the DVD video camera/recorder on and off, leaving the date/time feature unaffected. If the camera/recorder is to be left unattended for a long period of time, turn it off.

WARNING : TO PREVENT FIRE OR SHOCK HAZARD, DO NOT EXPOSE THIS UNIT TO RAIN OR MOISTURE.

WARNING : TO PREVENT FIRE OR SHOCK HAZARD, USE THE RECOMMENDED ACCESSORIES ONLY.



WARNING: TO PREVENT FIRE OR SHOCK HAZARD, BE SURE TO USE THE SPECIFIED AC ADAPTER/CHARGER (DZ-ACS2).

The DVD video camera/recorder and AC adapter/charger have the following caution marks.



CAUTION

**RISK OF ELECTRIC SHOCK
DO NOT OPEN**



CAUTION: TO REDUCE THE RISK OF ELECTRIC SHOCK, DO NOT OPEN. NO USER-SERVICEABLE PARTS INSIDE. REFER SERVICING TO QUALIFIED SERVICE PERSONNEL.

Identifications of caution marks



This symbol warns the user that uninsulated voltage within the unit may have sufficient magnitude to cause electric shock. Therefore, it is dangerous to make any kind of contact with any inside part of this unit.



This symbol alerts the user that important literature concerning the operation and maintenance of this unit has been included. Therefore, it should be read carefully to avoid any problems.

Precautions

WARNING: Many television programs and films are copyrighted. In certain circumstances, copyright law may apply to private in-home videotaping of copyrighted materials.

This Class B digital apparatus complies with Canadian ICES-003.

**CLASS 1
LASER PRODUCT**

CAUTION

This product contains a laser diode of higher class than 1. To ensure continued safety, do not remove any covers or attempt to gain access to the inside of the product. Refer all servicing to qualified personnel.

The liquid crystal display (LCD) panel is made by highly precise technology. More than 99.99% of its picture elements (pixels) are effective, but some (less than 0.01%) may appear as colored bright dots. This does not indicate a fault as the LCD panel stretches the limits of current technology.

Warning: This device complies with Part 15 of the FCC Rules. Operation is subject to the following two conditions: (1) This device may not cause harmful interference, and (2) this device must accept any interference received, including interference that may cause undesired operation.

Note: This equipment has been tested and found to comply with the limits for a Class B digital device, pursuant to Part 15 of the FCC Rules. These limits are designed to provide reasonable protection against harmful interference in a residential installation. This equipment generates, uses, and can radiate radio frequency energy and, if not installed and used in accordance with the instructions, may cause harmful interference to radio communications. However, there is no guarantee that interference will not occur in a particular installation. If this equipment does cause harmful interference to radio or television reception, which can be determined by turning the equipment off and on, the user is encouraged to try to correct by one or more of the following measures:

- Reorient or relocate the receiving antenna.
- Increase the separation between the equipment and receiver.
- Connect the equipment into an outlet on a circuit different from that to which the receiver is connected.
- Consult the dealer or an experienced radio/TV technician for help.

Caution to the user: Changes or modifications not expressly approved by the manufacturer void the user's authority to operate the equipment.

Microsoft®, Windows®, Windows® Me, Windows® 2000 Professional, and Windows® XP are registered trademarks of Microsoft Corporation.

Intel®, Pentium® Processor, and Celeron® Processor are registered trademarks of Intel Corporation.

IBM® and PC/AT® are registered trademarks of International Business Machines Corporation.

Manufactured under license from Dolby Laboratories.

“Dolby” and the double-D symbol are trademarks of Dolby Laboratories.

Other company names and product names listed are trademarks or brand names belonging to each individual company.

SD logo is a trademark.

IMPORTANT SAFETY INSTRUCTIONS

In addition to the careful attention devoted to quality standards in the manufacture of your video product, safety is a major factor in the design of every instrument. But, safety is your responsibility too. This page lists important information that will help to assure your enjoyment and proper use of DVD video camera/recorder and accessory equipment.

- 1** Read these instructions.
- 2** Keep these instructions.
- 3** Heed all warnings.
- 4** Follow all instructions.
- 5** Do not use this apparatus near water.
- 6** Clean only with dry cloth.
- 7** Do not block any ventilation openings. Install in accordance with the manufacturer's instructions.
- 8** Do not install near any heat sources such as radiators, heat registers, stoves, or other apparatus (including amplifiers) that produce heat.
- 9** Protect the power cord from being walked on or pinched particularly at plugs, convenience receptacles, and the point where they exit from the apparatus.
- 10** Only use attachments/accessories specified by the manufacturer.
- 11** Use only with the cart, stand, tripod, bracket, or table specified by the manufacturer, or sold with the apparatus. When a cart is used, use caution when moving the cart/apparatus combination to avoid injury from tip-over.

- 12** Unplug this apparatus during lightning storms or when unused for long periods of time.
- 13** Refer all servicing to qualified service personnel. Servicing is required when the apparatus has been damaged in any way, such as power-supply cord or plug is damaged, liquid has been spilled or objects have fallen into the apparatus, the apparatus has been exposed to rain or moisture, does not operate normally, or has been dropped.
- 14** The apparatus shall not be exposed to dripping or splashing and that no objects filled with liquids, such as vases, shall be placed on the apparatus.

Cautions When Using

Handle the liquid crystal display (LCD) with care:

- The LCD is a very delicate display device: Do not press its surface with force, hit it or prick it with a sharp object.
- If you push the LCD surface, unevenness in display may occur. If unevenness does not disappear soon, turn the DVD video camera/recorder off, wait for a few moments, and then turn it on again.
- Do not place the DVD video camera/recorder with the open LCD screen down.
- Close the LCD monitor when not using the DVD video camera/recorder.

Liquid crystal display (LCD) and viewfinder:

- The LCD screen and viewfinder are the products of highly precise technology. Among the total number of pixels (approx. 120,000 pixels for LCD monitor and equivalent to approx. 200,000 pixels for viewfinder), 0.01% or less pixels may be missing (black dots) or may remain lit as colored dots (red, blue, green). This shows the limitations of the current technology, and does not indicate a fault that will interfere with recording.
- The LCD screen and viewfinder will be slightly dimmer than usual when the DVD video camera/recorder is at low temperature, as in cold areas, or immediately after power is turned on. Normal brightness will be restored when the temperature inside the DVD video camera/recorder rises.

Hold the DVD video camera/recorder correctly:

- Do not hold the viewfinder or LCD monitor when lifting the DVD video camera/recorder: The viewfinder or LCD monitor could detach and the DVD video camera/recorder may fall.

Do not subject the DVD video camera/recorder to impact:

- This DVD video camera/recorder is a precision machine. Take great care that you do not strike it against a hard object or let it fall.
- When using a tripod, firmly secure the DVD video camera/recorder on it. Do not use the DVD video camera/recorder with a tripod in a place where it is subject to severe vibrations or impact.

No sand or dust!

- Fine sand or dust entering the DVD video camera/recorder or AC adapter/charger could cause malfunctions or defects.

No water or oil!

- Water or oil entering the DVD video camera/recorder or AC adapter/charger could cause electric shock, malfunctions or defects.

Heat on surface of product:

- The surfaces of the DVD video camera/recorder, AC adapter/charger and battery will be slightly warm, but this does not indicate a fault.

Screen on connected TV:

- Never leave the disc navigation screen, still image or camera image displayed on your TV to which the DVD video camera/recorder is connected: Doing so could result in displayed image retention or phosphor degradation of TV screen.

Be careful of ambient temperature:

- Using the DVD video camera/recorder in a place where the temperature is over 104°F (40°C) or under 32°F (0°C) will result in abnormal recording/playback.
- Take care that the temperature of this DVD video camera/recorder, when connected to PC does not rise excessively (reference for usage: approx. 30 minutes at about 86°F (30°C)).
- Do not leave the DVD video camera/recorder on beach sand or in a closed vehicle where the temperature is very high for a long time: This could cause malfunctions.

Do not point directly at the sun:

- If direct sunlight strikes the lens or viewfinder, the DVD video camera/recorder could malfunction or a fire could occur.
- Do not leave the DVD video camera/recorder with the LCD screen exposed to direct sunlight: This could cause malfunctions.

Do not use the DVD video camera/recorder near TV or radio:

- This could cause noise to appear on the TV screen or in radio broadcasts.

Do not use the DVD video camera/recorder near strong radio waves or magnetism:

- If the DVD video camera/recorder is used near strong radio waves or magnetism, such as near a radio wave tower or electric appliances, noise could enter video and audio that are being recorded. During playback of normally recorded video and audio, noise may also be present in picture and sound.
At worst the DVD video camera/recorder could malfunction.

Do not expose the DVD video camera/recorder to soot or steam:

- Thick soot or steam could damage the DVD video camera/recorder case or cause malfunctions.

Do not use the DVD video camera/recorder near corrosive gas:

- If the DVD video camera/recorder is used in a place where there is dense exhaust gas generated by gasoline or diesel engine, corrosive gas such as hydrogen sulfide, or sulfur such as in a hot spring area, the external or internal terminals could corrode, which would disable normal operation, or the battery connecting terminals could corrode, so power will not turn on.

Do not use the DVD video camera/recorder near ultrasonic humidifier:

- With some water in humidifier, calcium and other chemicals dissolved in water could scatter in the air, and white particles could adhere to the optical head of the DVD video camera/recorder, which could cause it to operate abnormally.

Do not expose the DVD video camera/recorder to insecticide:

- Insecticide entering the DVD video camera/recorder could dirty the lens in laser pickup block, and in such a case the DVD video camera/recorder might not operate normally. Turn the DVD video camera/recorder off and cover it with vinyl sheet, etc. before using insecticide.

Do not use a generally available 8 cm CD lens cleaner:

- Cleaning the lens is not necessary when using this DVD video camera/recorder in the usual way.
- Using 8 cm CD lens cleaner could cause this DVD video camera/recorder to be faulty.
- If you have to clean the lens, use a Hitachi Maxell cleaner that is exclusively for 8 cm DVD discs.

Be careful of moisture condensation:

- When you move the DVD video camera/recorder between places where the difference in temperatures is great – such as entering a lodge from a ski slope or going out of a cooled room or vehicle – condensation (vapor in air warmed or cooled to water droplets) could occur on the lens and/or inside the DVD video camera/recorder. If condensation occurs, do not open the cover of disc or card insertion block if possible. If condensation occurs on the lens, wipe it off with a soft, dry cloth. Even if the external surface of DVD video camera/recorder has dried, condensation may remain inside: Turn the DVD video camera/recorder off and leave it in a dry place for at least 1 – 2 hours before using it again.

Do not use the DVD video camera/recorder for a long uninterrupted period of time:

- This DVD video camera/recorder cannot be used for a long time continuously as a surveillance camera/monitor. If you use it for a long continuous period of time, the temperature of DVD video camera/recorder could exceed the limit and the recording/playback operation may slow down or other faults could occur. If this happens, turn it off and wait for a while before using it again.

Do not turn the DVD video camera/recorder off while the ACCESS/PC indicator or CARD ACCESS indicator is lit or blinking:

- The ACCESS/PC or CARD ACCESS indicator is lit or blinking to show that data is being written to disc or card, or being read from it. At this time, do not do any of the following, so as not to damage the data:
 - Remove battery
 - Disconnect AC adapter/charger
 - Plug or unplug PC connection cable
 - Remove disc or card
 - Subject DVD video camera/recorder to severe vibrations or impact.
 - Violently open or close the LCD monitor

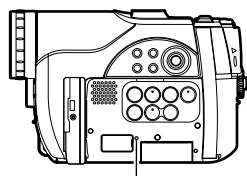
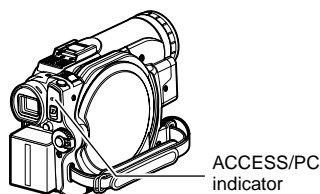

If you turn the DVD video camera/recorder off while the ACCESS/PC or CARD ACCESS indicator is lit or blinking, turn it on again with the disc or card loaded in it: Repair of the disc or card will be executed automatically (see page 160).

Do not wipe the DVD video camera/recorder case with benzene or thinner:

- The coating of case could peel off or the case surface could deteriorate.
- When using a chemical cleaning cloth, follow the instructions.

Also read the instructions attached with optional accessories:

- For optional accessories, observe the cautions and follow instruction manuals attached.

The battery provided has not been charged at time of purchase:

- Charge it before using the DVD video camera/recorder (see page 39).
- The battery will discharge as time passes. (The battery is produced so that it discharges on its own in order to protect its characteristics.)

Disc cannot be inserted or removed unless a charged battery or AC adapter/charger is connected to the DVD video camera/recorder.

Be sure to set the power switch to “OFF” when turning the DVD video camera/recorder off:

- Disconnecting the battery or AC adapter/charger while the DVD video camera/recorder is being powered could cause a fault.

Cautions When Storing

Do not leave the DVD video camera/recorder in a place where the temperature is very high for a long period of time:

- The temperature inside a closed vehicle or trunk can become very high in a hot season. If you leave the DVD video camera/recorder in such a place, it could malfunction or the case could be damaged. Also, do not expose the DVD video camera/recorder to direct sunlight or place it near a heater.

Do not store the DVD video camera/recorder in a place where the humidity is high or in a dusty place:

- Dust entering the DVD video camera/recorder could cause malfunctions. If the humidity is high, the lens could be moldy, and the DVD video camera/recorder could become inoperable. It is recommended that you put the DVD video camera/recorder with desiccant in a box when storing it in a closet, etc.

Do not store the DVD video camera/recorder in a place subject to strong magnetism or intense vibrations:

- This could cause malfunctions.

Detach the battery from the DVD video camera/recorder and store it in a cool place:

- Leaving the battery attached or storing it at high temperature could shorten its life.

Suggestions and Restrictions

Make a trial recording:

- Always make a trial recording before doing actual recording to make sure that recording is normal. The data that have not been stored normally because of a defect in the DVD video camera/recorder cannot be restored.

It is recommended that you use DVD-RAM disc from which recorded contents can be deleted for trial recording.

Do not use the DVD video camera/recorder for professional applications:

- This DVD video camera/recorder is designed and produced for home-use recording and playback.

The recorded contents cannot be compensated for:

- Hitachi cannot compensate for any damages caused when recording is not made normally or recorded contents cannot be played back because of a defect in the DVD video camera/recorder, disc or card. Also, Hitachi cannot be responsible for your recorded video and audio.
- If you or a third party make a mistake when handling this DVD video camera/recorder, disc, card, etc., the recorded contents may be lost. We cannot be responsible for compensation for damage due to loss of recorded contents.

Copyright:

- Data recorded on the disc or card in this DVD video camera/recorder using other digital/analog media or devices are protected by the copyright act and cannot be used without permission of the owner of copyright, except for personal enjoyment. Be aware that recording is restricted for some demonstrations, performances and exhibitions, even for personal enjoyment.

Read This First

To guide you, we have included following six chapters.

- The section on “Setups” explains how to set up the DVD video camera/recorder, battery, and set the date/time.
- The section on “Basic Techniques” explains the basic operation of this DVD video camera/recorder – recording of movies, still images, external input, and playback of recorded images.
- The section on “Advanced Techniques” explains settings on this DVD video camera/recorder for more advanced usage.
- The section on “Disc Navigation” explains editing with Disc Navigation: Refer to this section when finalizing DVD-R disc and initializing DVD-RAM disc.
- The section on “Connecting to PC” explains the contents of provided CD-ROM and how to install the software included.
- “Subsidiary Information” includes an introduction to products sold separately, proper cleaning, and troubleshooting.

We want this manual to be as helpful as possible, so it includes two easy ways to find the information you need:

- A quick index for the information you use most often (this page).
- A detailed table of contents directing you to specific information quickly (see pages 12 – 14).

Get to know your DVD video camera/recorder by using this manual, and get to know Hitachi. We appreciate your business.

Quick Index

Available Discs	24
Recording Movie	49
Playing Back.....	58
Connecting to a TV.....	77
Functions Available with Disc Navigation	107
Connecting to PC	138

With this DVD video camera/recorder you can view the picture being recorded or the playback picture whether on the LCD monitor or in the viewfinder. Opening or closing the LCD monitor switches the picture to appear on the LCD monitor or in the viewfinder.

It is possible to switch the language in the on-screen display of this DVD video camera/recorder (see page 101).

About This Manual

● Displays in this manual

Understand that the displays are different from those you will actually see in the viewfinder or on the LCD screen.

● Notation of cancel button

Press the stop/cancel button to stop your operation midway, or return the menu screen to the preceding one. The expression “press the ■ button” will be used in this text.

● , and marks beside headings

Some functions of this DVD video camera/recorder are unavailable with disc or card used. Refer to the marks at right above each function to identify whether the disc or card is compatible with the function. Refer to these marks and identify the functions and operation to match the disc or card you use.

● Illustrations in this manual

Although the external appearances of DZ-GX20A, DZ-MV780A and DZ-MV730A are different, the method of operating these models is identical.

The illustrations of DZ-GX20A are used for the explanation in this text.

Introduction

● You can start recording immediately after stopping playback (p. 49, 58)

Unlike tape devices, you do not need to search for the recording start position or locate the beginning of blank portion.

You can stop playback and immediately start recording: New recording will not overwrite any previously recorded data.

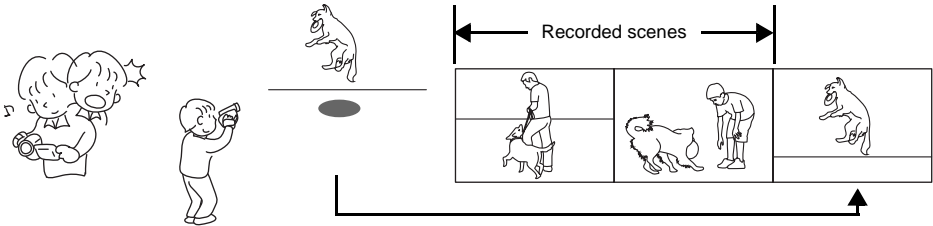

If you stop playback midway and start recording, overwrite will not occur.

● You can immediately play back desired recorded scenes (p. 105)

You do not need to rewind, unlike recorders using tape.

You can select any scene you want and immediately play it back (using Disc Navigation function).

● Use Disc Navigation to create your original movie (p. 124)

You can delete unnecessary scenes, move any scenes, etc., and create your original movie work (Play List).

Before editing

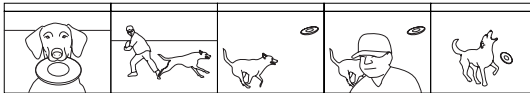

After editing

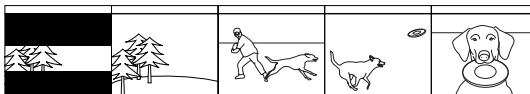

● You can easily edit scenes, which is quite difficult with tape (p. 83)

Using this DVD video camera/recorder, you can collect scenes of your child, for example, on play list of Disc Navigation function and create an original movie: Then simply play back the play list and dub it on VCR or DVD recorder.

Up to now, you had to repeatedly press buttons

With a DVD, you can simply play it back on this DVD video camera/recorder: Press the record button on VCR or DVD recorder.

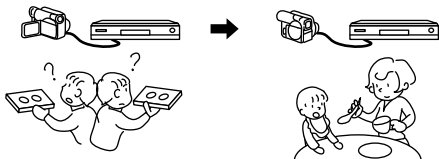

● Create original DVDs on PC (p. 147)

You can create an original DVD, using the provided software CD-ROM. The created DVD disc can be played back on DVD player/recorder, DVD-ROM drive, etc.

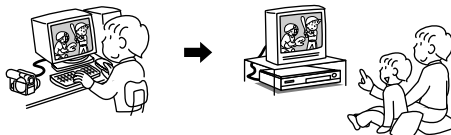

Original DVD being created

Playback of DVD

Table of Contents

Important Information.....	2
For Your Safety.....	2
Precautions.....	2
IMPORTANT SAFETY INSTRUCTIONS	4
Cautions When Using.....	5
Cautions When Storing.....	8
Suggestions and Restrictions	8
Read This First	9
About This Manual.....	9
Introduction	10
Table of Contents	12
Checking Provided Accessories	15
Names of Parts.....	16
Try Recording and Playing Back using Disc (Video and Photo).....	20
Try Recording and Playing Back using Card (Photo).....	22
Discs and Cards	24
AVAILABLE DISCS	24
INFORMATION ON DVD-R DISC	25
EXAMPLES OF DISCS THAT CANNOT BE USED ON THIS DVD VIDEO CAMERA/RECORDER:.....	25
HANDLING DISCS	26
DISC CLEANING.....	26
AVAILABLE CARDS.....	27
Storage Capacity on Disc or Card	28
RECORDABLE TIME OF MOVIE (VIDEO).....	28
RECORDABLE STILLs (PHOTOS) ON DISC	28
RECORDABLE STILLs (PHOTOS) ON CARD....	29
SIZE AND QUALITY OF PHOTOS	30

Setups

Setting Up the DVD Video Camera/ Recorder	31
HOLDING DVD VIDEO CAMERA/ RECORDER	31
ATTACHING SHOULDER STRAP.....	32
ATTACHING LENS CAP	32
INSERTING BATTERY INTO REMOTE CONTROL	33
REMOVING BATTERY FROM REMOTE CONTROL	33
VIEWING IMAGE ON LCD MONITOR SCREEN.....	35
CLOSING LCD MONITOR	36
VIEWING SUBJECT THROUGH VIEWFINDER	36
SETTING DATE AND TIME	37
CHANGING DISPLAY FORMAT OF DATE AND TIME.....	38
Setting Up the Battery.....	39
CHARGING BATTERY.....	39

ATTACHING BATTERY TO DVD VIDEO CAMERA/RECORDER.....	40
REMOVING BATTERY.....	40
BATTERY REMAINING LEVEL INDICATOR.....	42
EFFICIENT USE OF BATTERY	42
USING DVD VIDEO CAMERA/RECORDER WITH AC ADAPTER/CHARGER.....	43
Turning DVD Video Camera/Recorder On and Off.....	44
Inserting and Removing Disc.....	45
INSERTING DISC.....	45
REMOVING DISC.....	47
Inserting and Removing Card	48

Basic Techniques

Recording Movie.....	49
Recording Stills.....	51
On-Screen Information	52
INFORMATION DISPLAY DURING RECORDING.....	52
Zooming.....	56
MACRO RECORDING	57
RECORDING SUBJECTS FOR STRONGER WIDE-ANGLE OR TELEPHOTO EFFECT	57
Playing Back	58
PLAYING BACK	58
PLAYBACK FROM START OF DISC OR CARD.....	59
SEARCH PLAYBACK OF MOVIE	59
FRAME ADVANCE/FRAME BACK/SLOW PLAYBACK OF MOVIE	59
SKIP PLAYBACK OF MOVIE.....	60
PLAYING BACK STILLs	60
JUMPING TO SPECIFIED POINT (GO TO).....	61
On-Screen Information Display.....	62
INFORMATION DISPLAY DURING PLAYBACK.....	62
Checking Flow of Quick Menu	63
Camera Functions	
FLOW OF QUICK MENU WHEN RECORDING MOVIE:.....	65
FLOW OF QUICK MENU WHEN RECORDING PHOTO (DISC):.....	66
FLOW OF QUICK MENU WHEN RECORDING PHOTO (CARD):.....	68
Disc Navigation Functions	
FLOW OF QUICK MENU (WITH DVD-RAM DISC):.....	70
FLOW OF QUICK MENU (WITH DVD-R DISC):.....	71
FLOW OF QUICK MENU (WITH CARD):.....	71
Manually Focusing Subject.....	72
FOCUSING DURING RECORDING.....	72

Adjusting Brightness of Image to be recorded (Exposure)	74
Compensating for Backlight	74
Using External Microphone	75
Built-in Video Flash (for DZ-GX20A only)	76
Viewing on TV Screen.....	77
CONNECTING TO A TV.....	77
VIEWING ON TV SCREEN	78
Playback on DVD Recorder/Player	79
PLAYING BACK DVD-RAM DISC	79
PLAYING BACK DVD-R DISC	79
Recording (Dubbing) Images	80
RECORDING (DUBBING) IMAGES FROM OTHER VIDEO DEVICE.....	80
RECORDING (DUBBING) IMAGES FROM OTHER VIDEO CAMERAS	82
RECORDING (DUBBING) IMAGES ON OTHER VIDEO DEVICES	83
Advanced Techniques	
Checking Flow of Normal Menu	84
Camera Functions	
Setting Up Camera Functions	86
SELECTING SHOOTING MODE TO MATCH THE SUBJECT (SWITCHING PROGRAM AE MODE).....	86
RECORDING DARK SUBJECTS USING LCD MONITOR LIGHT	87
ADJUSTING COLOR (WHITE BALANCE).....	88
USING THE ELECTRONIC IMAGE STABILIZER (EIS)	90
RECORDING SUBJECT USING LARGE MAGNIFICATION (DIGITAL ZOOM)	90
REDUCING WIND NOISE DURING RECORDING (MIC.FILTER)	90
Setting Up Record Functions	91
SWITCHING MOVIE QUALITY (VIDEO MODE)	91
SETTING TO WIDE TV SCREEN MODE (16:9 MODE).....	92
SWITCHING QUALITY OF STILL IMAGE (QUALITY)	94
RECEIVING IMAGE FROM ANOTHER DEVICE (INPUT SOURCE)	94
SWITCHING EXTERNAL INPUT RECORDING METHOD (PHOTO INPUT)	95
SELF-TIMER	96
SETTING ON-SCREEN DISPLAY OUTPUT ON OR OFF (OSD OUTPUT).....	97
LCD/EVF Setup.....	98
SETTING BRIGHTNESS OF LCD SCREEN (LCD BRIGHTNESS).....	98
SETTING BRIGHTNESS OF VIEWFINDER (EVF BRIGHTNESS)	98
SETTING COLOR DENSITY (COLOR LEVEL)	99
ALWAYS DISPLAYING IMAGE IN VIEWFINDER	99
Initial Settings.....	100

SWITCHING OPERATING SOUND ON OR OFF (BEEP).....	100
TURNING DVD VIDEO CAMERA/RECORDER OFF AUTOMATICALLY (POWER SAVE)	100
TURNING RECORD LED ON OR OFF (RECORD LED)	101
CHANGING DISPLAY LANGUAGE (LANGUAGE).....	101
RESETTING MENU SETTINGS TO DEFAULTS (RESET).....	102
Disc Navigation	
Using Disc Navigation	103
STARTING OR TERMINATING DISC NAVIGATION	103
PLAYING BACK FROM DISC NAVIGATION SCREEN	105
SELECTING MULTIPLE SCENES	106
SELECTING CONSECUTIVE SCENES TOGETHER	106
FUNCTIONS AVAILABLE WITH DISC NAVIGATION	107
UNDERSTANDING FLOW OF DISC NAVIGATION MENU	108
Scene	110
DELETING SCENES (EDIT – DELETE)	110
DIVIDING MOVIES (EDIT – DIVIDE)	112
COMBINING MULTIPLE SCENES (EDIT – COMBINE).....	113
ARRANGING ORDER OF SCENES (EDIT – MOVE).....	113
DIRECTING SCENES EFFECTIVELY (EFFECT – FADE).....	114
PLAYING BACK BY SKIPPING SCENES (EFFECT – SKIP)	115
CHANGING IMAGES FOR THUMBNAILS (EFFECT – THUMBNAIL).....	116
COPYING STILLS ON DVD-RAM DISC TO CARD (COPY)	117
LOCKING SCENES ON CARD (LOCK)	118
SELECTING SCENES USING MENU SCREEN (SELECT).....	119
DISPLAYING INFORMATION USING MENU SCREEN (DETAIL)	120
Program.....	121
WHAT IS “PROGRAM”?.....	121
SWITCHING TO THUMBNAIL DISPLAY OF SPECIFIC DATE (SWITCH)	121
PLAYING BACK PROGRAM (PLAY)	122
CHANGING TITLE OF PROGRAM (TITLE)	122
Play List.....	124
WHAT IS “PLAY LIST”?.....	124
CREATING NEW PLAY LIST (CREATE)	124
SWITCHING TO DISPLAY OF EACH PLAY LIST (SWITCH).....	125
PLAYING BACK A PLAY LIST (PLAY).....	125
ADDING SCENES TO PLAY LIST (EDITING PLAY LIST)	126
DELETING SCENES FROM PLAY LIST (EDITING PLAY LIST)	127

ADDING SCENES USING SUBMENU FOR EDITING (EDITING PLAY LIST).....	127	No DVD Video Camera/Recorder Operation – Check the Following:.....	158
DELETING SCENES USING SUBMENU FOR EDITING (EDITING PLAY LIST).....	128	Trouble Messages	160
SELECTING SCENES USING SUBMENU FOR EDITING (EDITING PLAY LIST).....	128	Troubleshooting	167
ARRANGING ORDER OF SCENES (MOVE) ...	129	System Reset	174
CHANGING TITLE OF PLAY LIST (TITLE)	130	Major Specifications.....	175
DELETING PLAY LIST (DELETE)	130	To Order in the United States	178
Go To.....	131	To Order in the Canada	178
TOP (END)	131	Index	179
Disc or Card Management.....	132	Be sure to read the following before opening the package of CD-ROM	181
INITIALIZING DISC OR CARD (FORMAT DISC. FORMAT CARD)	132		
PROTECTING DISC FROM WRITING (PROTECT DISC).....	133		
VERIFYING REMAINING FREE SPACE ON DISC OR CARD (CAPACITY)	133		
UPDATING CONTROL INFORMATION OF DVD-RAM DISC (UPDATE CONTROL INFO.).....	134		
FINALIZING DVD-R DISC (FINALIZE DISC)	135		
Others.....	136		
DISPLAYING MOVIES OR STILLS INDEPENDENTLY (CATEGORY)	136		
PLAYING BACK SCENES REPEATEDLY (REPEAT PLAY).....	136		
SLIDE SHOW (CONTINUOUS PLAYBACK OF STILLS).....	137		

Connecting to PC (DZ-GX20A/DZ-MV780A)







THE FOLLOWING ARE AVAILABLE WHEN CONNECTING TO PC.....	138
Contents on Provided CD-ROM	140
Installing Software	142
DISPLAYING INSTALLER SCREEN	142
INSTALLING SOFTWARE	143
Creating DVD Video from DVD-RAM Disc Recorded on DVD Video Camera/ Recorder	147
Uninstalling Software	149
Cautions When Using DVD Video Camera/ Recorder by Connecting It to PC	149
Introduction to Video Editing Software.....	150

Subsidiary Information

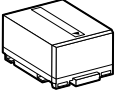
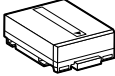
Introduction to Optional Accessories	151
CAMERA ACCESSORIES	151
POWER SUPPLY	151
Removing Disc from Its Package.....	152
REMOVING AND REPLACING FROM/IN ROUND DVD HOLDER	152
REMOVING DISC FROM CARTRIDGE.....	153
Cleaning.....	153
Changing Setting of Demonstration.....	154
Terminology	155

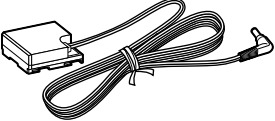
Checking Provided Accessories

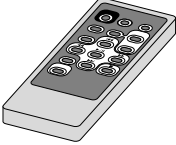
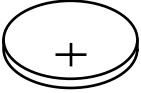
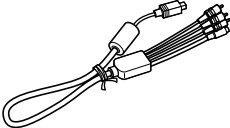
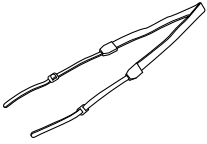
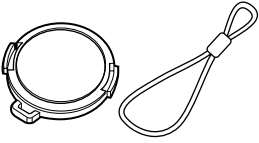
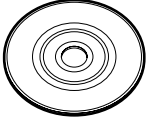
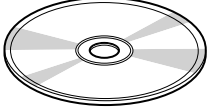
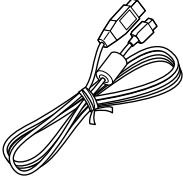
Make sure that you have all the following accessories in package:

<p>Battery (model DZ-BP14S): For DZ-GX20A only. Portable power supply for this DVD video camera/recorder. Charge it before use.</p> 	<p>Battery (model DZ-BP7S): For DZ-MV780A or DZ-MV730A only. Portable power supply for this DVD video camera/recorder. Charge it before use.</p> 	<p>AC adapter/charger (model DZ-ACS2): Used to power the DVD video camera/recorder from AC outlet, or charge battery.</p> 
<p>DC power cord: When powering the DVD video camera/recorder from household AC outlet, use this cord to connect the DVD video camera/recorder and AC adapter/charger.</p> 	<p>Power cable: Connect between household AC outlet and AC adapter/charger.</p> 	<p>Infrared remote control (model DZ-RM4W): Use to control the DVD video camera/recorder from a distance. For DZ-GX20A or DZ-MV780A only.</p> 
<p>Lithium battery (model CR2032): To power the remote control. For DZ-GX20A or DZ-MV780A only.</p> <p>WARNING: Keep this battery away from children. If swallowed, consult a physician immediately for emergency treatment.</p> 	<p>AV/S input/output cable: Used when viewing the picture played back on the DVD video camera/recorder on TV screen, or input or output video from/to another video device.</p> 	<p>Shoulder strap: Attach to the DVD video camera/recorder to hang it from shoulder.</p> 
<p>Lens cap and lens cap string: Attach the lens cap when not recording, to protect the lens.</p> 	<p>Single-sided 8 cm DVD-R disc: To record videos (movies) on this DVD video camera/recorder. For DZ-GX20A or DZ-MV780A only.</p> 	<p>Software CD-ROM: Use this CD-ROM when connecting the DVD video camera/recorder to PC. For DZ-GX20A or DZ-MV780A only.</p> 
<p>PC connection cable: Use this cable when connecting the DVD video camera/recorder to PC. For DZ-GX20A or DZ-MV780A only.</p> 	<p>Disc cleaning cloth: Always use this to clean discs.</p> 	

Names of Parts

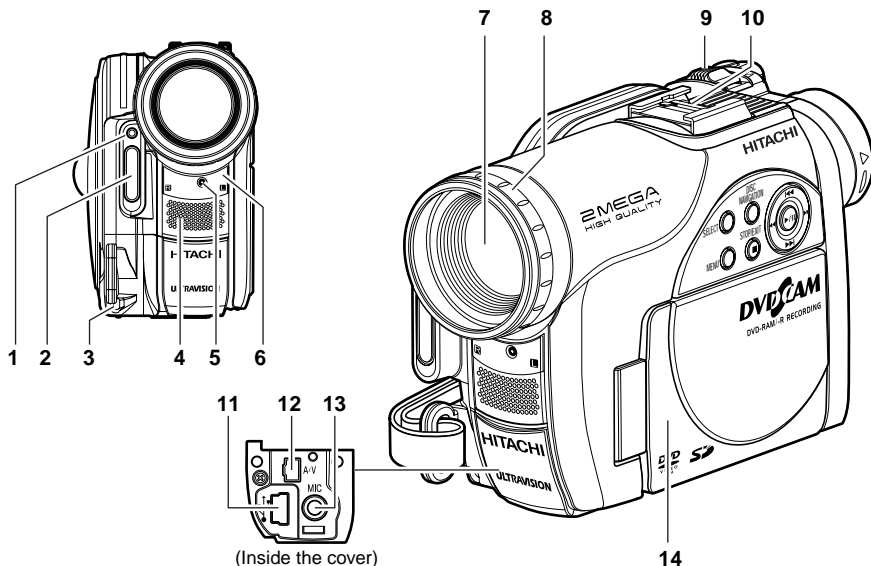

**1 Light receiving sensor
(for DZ-GX20A only)**

This sensor controls the amount of light to be emitted from the built-in flash. Take care not to block with hand, etc. during recording.

2 Flash (for DZ-GX20A only) (p. 76)

3 Lens cap string attachment hole (p. 32)

4 Stereo microphone (p. 75)

5 Recording indicator (p. 101)

The red indicator will light during recording.

6 Infrared receiver (p. 34)

When the remote control is used to operate the DVD video camera/recorder, this receiver will receive the infrared signal.

**7 Optical 10× zoom lens
(for DZ-GX20A or DZ-MV780A only)
Optical 16× zoom lens
(for DZ-MV730A only)
(p. 56)**

8 Lens hood (p. 57)

Always remove this lens hood when using generally available tele-conversion or wide-conversion lens.

9 Zoom lever (p. 56)

Push the lever to the T side for telephoto, or to the W side for wide-angle.

10 Accessory shoe

For DZ-GX20A or DZ-MV780A only:
The optional video flash can be attached here. (See the instruction manual of device to be attached for details.)

**11 PC connection terminal (TO PC) (p. 149)
[for DZ-GX20A or DZ-MV780A only]**

12 AV input/output jack (p. 77, 80)

13 External microphone jack (p. 75)

**14 2.5" type liquid crystal display (inside)
(p. 35)**

Although the external appearances of DZ-GX20A, DZ-MV780A and DZ-MV730A are different, the method of operating both models is identical. DZ-GX20A illustrations are used in this manual.

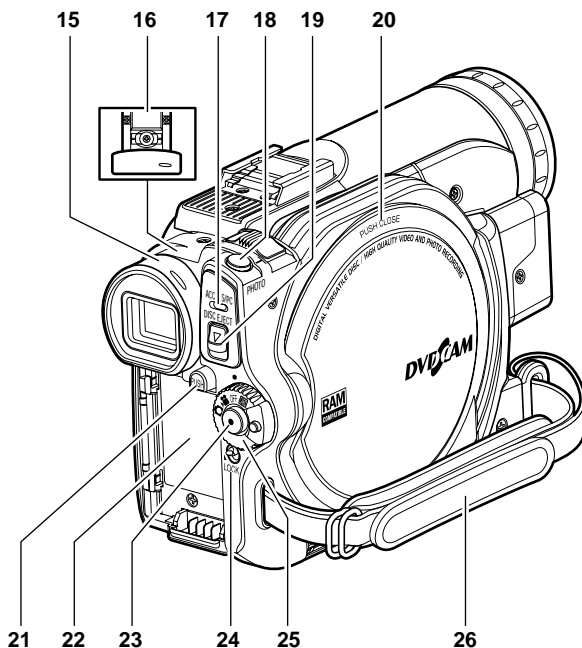

15 Viewfinder (p. 36)

16 Diopter control (p. 36)

To adjust the focus of image appearing in the viewfinder. (Pull out the viewfinder.)

**17 ACCESS/PC indicator
(for DZ-GX20A or DZ-MV780A only)**

**ACCESS indicator
(for DZ-MV730A only)
(p. 7, 49, 51)**

Will blink or light when the disc in DVD video camera/recorder is accessed (write or read is executed) or the DVD video camera/recorder is connected to PC.

18 PHOTO button (p. 51)

19 DISC EJECT button (p. 45)

Press down and release this button to open the disc guide.

20 Disc insertion block (p. 45)

21 BATTERY EJECT button (p. 40)

Press this button when removing the battery.

22 Battery attachment platform (p. 40)

23 Record button (REC) (p. 49)

24 LOCK switch (p. 50)

It is recommended that you set the LOCK switch to  (to the upper position) to prevent the power switch in the "⏻" position from accidentally moving to "⏻".

25 Power switch (p. 44)

26 Hand strap (p. 31)

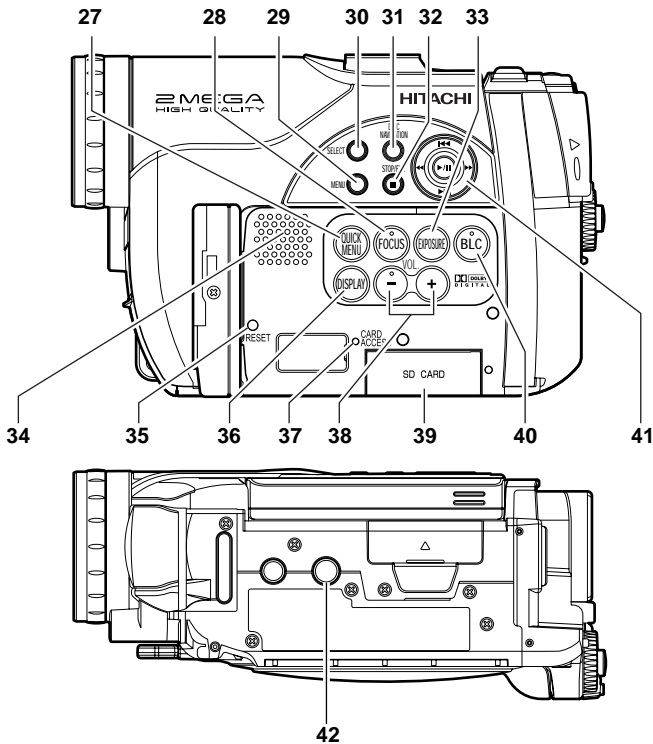

27 QUICK MENU button (p. 63)

To display only the functions that you frequently use (simple menus).

28 FOCUS button (p. 72)

To switch between manual focus and auto-focus.

29 MENU button (p. 84, 86, 111)

Press this button to display the menu for setting camera functions and Disc Navigation.

30 SELECT button (p. 106)

31 DISC NAVIGATION button (p. 103)

32 Stop/cancel button (p. 9, 58, 103)

To end playback or cancel setting of menu.

33 EXPOSURE button (p. 74)

Press this button to adjust the exposure.

34 Speaker (p. 58)

35 RESET button (p. 174)

To reset all settings to defaults (status when the DVD video camera/recorder was shipped from the factory)

36 DISPLAY (Screen display) button (p. 62)

Press this button to display the details of image being played back or camera setting status, or switch the display off.

37 CARD ACCESS indicator (p. 7, 51)

38 Volume control buttons (VOL)/

⊖ ⊕ buttons (p. 58, 72, 74)

To adjust the volume of sound from speaker, etc.

39 Card insertion block (p. 48)

40 BLC (backlight compensation) button (p. 74)

Press this button when subject is being lighted from rear.

41 ◀◀/▶▶ / ◀◀/▶▶ / ▶▶/|| buttons (p. 37, 58, 64, 84)

Use these buttons to select a scene or menu item, and then press the center (▶▶/||) to play back the scene, or designate an option from the menu.

42 Tripod threaded hole

Used to attach the DVD video camera/recorder to a tripod.

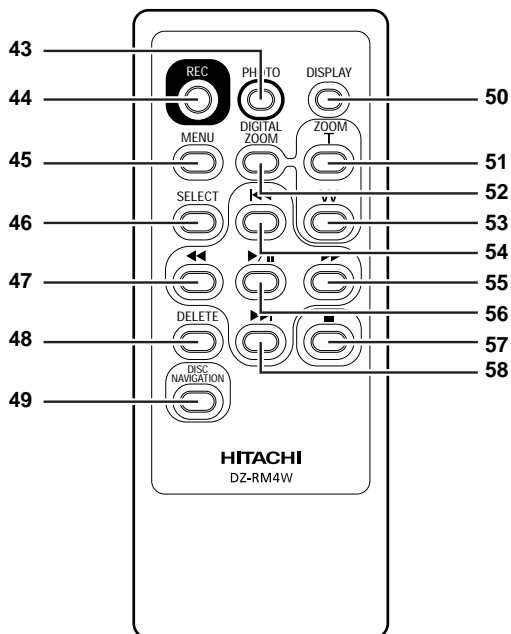

43 PHOTO button (p. 51)

44 REC button (p. 49)

45 MENU button (p. 84, 86, 111)

46 SELECT button (p. 106)

47 Reverse search button (p. 59)

48 DELETE button (p. 110)

49 DISC NAVIGATION button (p. 103)

51 ZOOM T button (p. 56)

52 DIGITAL ZOOM button (p. 56)

53 ZOOM W button (p. 56)

54 Reverse skip button (p. 60)

55 Forward search button (p. 59)

56 Play/pause button (p. 58)

57 Stop button (p. 9, 58, 105)

58 Forward skip button (p. 60)

* The buttons on remote control will function the same as those on DVD video camera/recorder.

Try Recording and Playing Back using Disc (Video and Photo)

Before You Begin

- It is recommended that you use a DVD-RAM disc for trial recording, since you can delete the recorded contents (p. 24).

You can record both videos and photos on DVD-RAM disc; only videos on DVD-R disc.

1 Connect a power supply (p. 43).

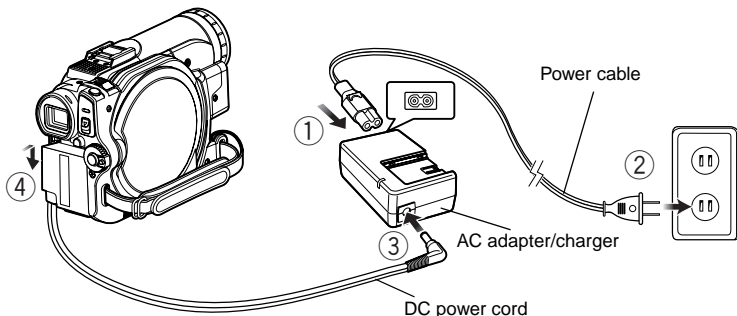

2 Insert a disc (p. 45).

- ① Press down the DISC EJECT button once and release it.

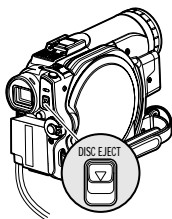

- ② Gently open the cover until it stops.

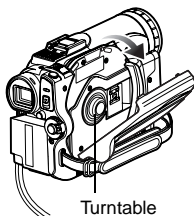



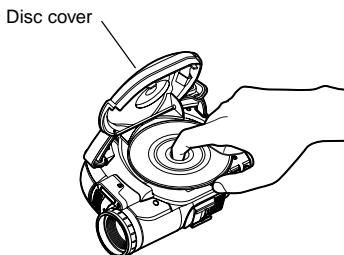

- ③ Push the disc against the turntable at the center of disc insertion block to lock it until a click is heard, and then close the cover of disc insertion block: Do not touch the disc recording surface or pickup lens at this time.

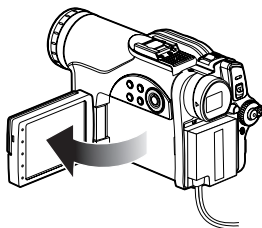

3 Start recording (p. 49).

- ① Open the LCD monitor (p. 35), or pull out the viewfinder (p. 36).



- ② While holding down the button on the right of power switch, set the switch to “” or “” (only “” for DVD-R disc).

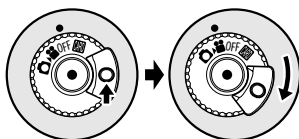

- ③ When recording a video, press the REC button.

Recording will start.



Pressing the REC button again will stop recording ().

When recording a photo, press the PHOTO button.

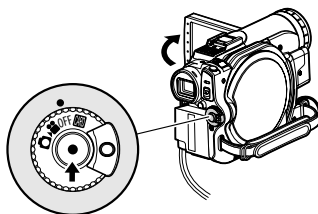
Pressing PHOTO half way (half press) allows you to focus the subject, and the “●||” indicator will turn purple. Press PHOTO all the way down to record.



Note:

- When using an unformatted disc, format (initialize) it on this DVD video camera/recorder. If unformatted disc is inserted into this DVD video camera/recorder, a message will appear: Format the disc following the instructions on screen (p. 46, 132). Initializing the DVD-RAM disc will erase all the recorded contents: Make sure the contents on disc are not valuable before initializing the disc.
- See Check 1 on p. 158 if recording is not possible with “”.
- See Check 2 on p. 158 if recording is not possible with “”.

4 View the playback of recorded content on LCD monitor screen (p. 35).

- ① After recording is finished, press the  button.

The recorded scene will be played back.

- ② Press the  button to stop playback.

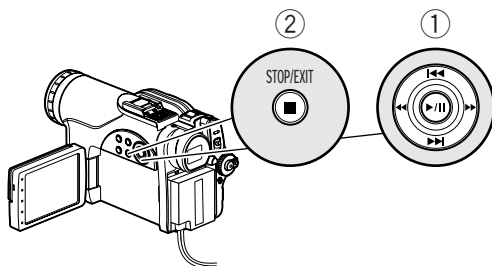

Try Recording and Playing Back using Card (Photo)

Photos can only be recorded on card sold separately.

1 Connect a power supply (p. 43).

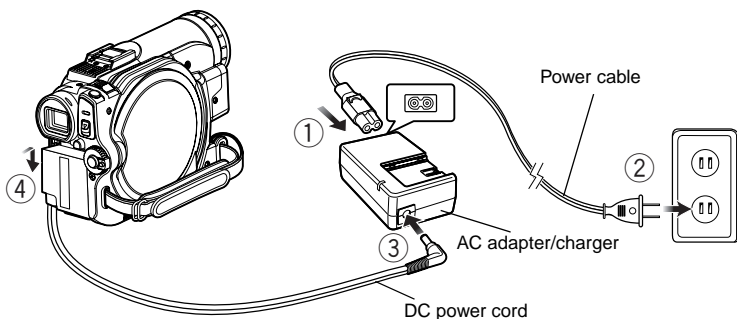

2 Insert a card (p. 48).

① Open the LCD monitor (p. 35).

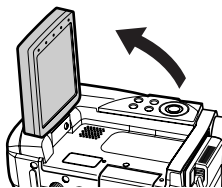

② Open the cover of card insertion block with power turned off.

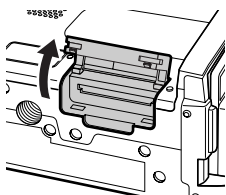

③ Put in a card.

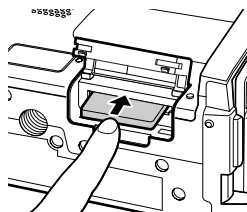

④ Insert the card all the way until it locks, and then close the cover of card insertion block.

3 Start recording (p. 51).

- ① Open the LCD monitor (p. 35).

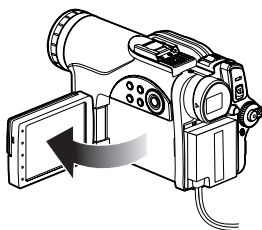

- ② While holding down the button on the right of power switch, set the switch to "CAM".

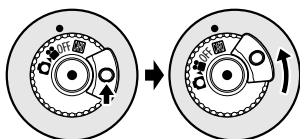

- ③ Press the PHOTO button half way (half press): When a subject image is focused, the "●||" indicator will turn purple.

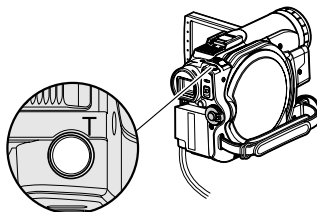

- ④ Press the PHOTO button all the way (full press).

Note:

- With the DZ-GX20A only, the built-in flash may emit light in a dark area (see page 76).
- See page 24 for the cards that can be used on this DVD video camera/recorder.
- See Check 2 on p. 158 if recording is not possible with "CAM".

4 View the playback of recorded content on LCD monitor screen (p. 35).

- ① Press the ►|| button in recording pause status: The recorded scene will be played back.
- ② Press the ■ button to stop playback.

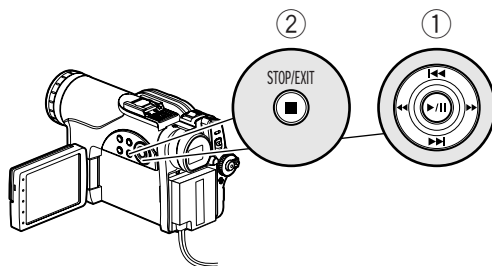

Discs and Cards

The following table lists the storage media (discs and cards) that can be used on this DVD video camera/recorder and the functions which are available with them:

Function	Media		
	DVD-RAM disc	DVD-R disc	SD memory card
Deleting and editing images	∴	x	∴
Playing back on other DVD devices	Possible on compatible machine*1	∴*2	x*4
Initialization	Unnecessary*3	Necessary	Unnecessary*3
Finalization	Unnecessary	Necessary	Unnecessary

∴: Functions available; x: Not available

*1: Can be played back on DVD players with a logo  or DVD recorders with a logo . Not playable on those machines, however, if they are not compatible with 8 cm DVD-RAM discs.



*2: Must be finalized (see "Terminology", p. 155) on this DVD video camera/recorder before DVD-R disc can be played back on DVD player or DVD recorder (see page 135). May not be playable on some DVD players or DVD recorders.

*3: When using media sold on market as labeled "formatted". The media whose initialization format is different can be used only after they are formatted on this DVD video camera/recorder.

*4: Some DVD devices can play SD memory cards.

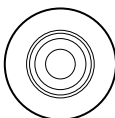
AVAILABLE DISCS



Usable discs and logos	
DVD-RAM Ver. 2.1 (8 cm)	
DVD-R [for General Ver. 2.0 (8 cm)]	

This DVD video camera/recorder can use only the 8-cm bare discs not packed in a square cartridge, square caddy case or round DVD holder. The discs in a square cartridge, square caddy case or round DVD holder can be used if they are removed from the package, but take great care not to dirty or scratch the bare disc (see pages 152 and 153).

Note:

- It is recommended that you use Hitachi Maxell HG type single-sided discs, since their compatibility with this DVD video camera/recorder has been confirmed. When using an HG type double-sided disc, take great care with handling it. Using a disc other than these discs may not allow the DVD video camera/recorder to deliver optimum performance.
- See page 25 for information on DVD-R disc.

INFORMATION ON DVD-R DISC

You cannot record a still on DVD-R disc, or delete any recorded images or data. For optimum recording on DVD-R disc, this DVD video camera/recorder writes control data to the disc in order to automatically make adjustments when it is inserted and ejected accompanying recording. If the disc has no area to be written for adjustment, recording may not be possible. To prevent this, do not insert or eject a DVD-R disc accompanying recording more than 100 times.

Although some models are compatible with the VR mode using DVD-R disc, this DVD video camera/recorder is not compatible with that mode.

● Finalizing DVD-R disc

Before using the 8 cm DVD-R disc provided on this DVD video camera/recorder on a DVD player or DVD video recorder that is compatible with 8 cm DVD-R disc, the disc must be finalized on this DVD video camera/recorder. For the finalizing procedure of 8 cm DVD-R disc, refer to “FINALIZING DVD-R DISC (FINALIZE DISC)” (p. 135).

Note:

- When using an unformatted DVD-R disc, it is necessary to format it on this DVD video camera/recorder (see page 46).
- Do not insert a DVD-R disc recorded on this DVD video camera/recorder but not finalized, into a recordable device, such as a DVD recorder: The recorded data may be damaged (except for devices that allow playback of a DVD-R disc not finalized on this DVD video camera/recorder).
- DVD-R discs edited and finalized on PC or those finalized on another DVD recorder may not be playable on this DVD video camera/recorder, depending on the editing software used or recorded status of DVD-R disc.
- If you insert a DVD-R disc recorded on a DVD video camera/recorder other than DZ-GX20A, DZ-MV780A or DZ-MV730A and not finalized, the Disc Navigation screen will automatically start, and no recording can be done on the disc nor can it be finalized.

EXAMPLES OF DISCS THAT CANNOT BE USED ON THIS DVD VIDEO CAMERA/RECORDER:

- DVD-RAM (2.6 GB) Ver. 1.0
- CD-RW
- DVD-R (3.9 GB) Ver. 1.0
- CD
- DVD-R (4.7 GB) for Authoring Ver. 2.0
- LD
- DVD-RW
- MO
- DVD+RW
- MD
- DVD+R
- iD
- DVD-ROM
- Floppy disk
- DVD-Video
- Discs other than those with diameter of 8 cm
- CD-R
- CD-ROM
- DVD-R (double-layered)

Note:

Discs recorded on PC or DVD recorder may not be playable on this DVD video camera/recorder: If so, message “This disc cannot be used.” will appear. Also, blue thumbnails will appear (Fig. 1* on page 26), or normal playback will not be possible.

HANDLING DISCS

● Using discs

DVD-RAM and DVD-R discs are very delicate recording media. Carefully read the following cautions and observe them:

- Always use a brand new disc when recording important material.
- Be sure not to touch the recording surface of disc, or dirty or scratch it.
- **If there is dust, scratch, dirt on disc or if it is warped**, the following phenomena may occur:

- Block noise in playback image
- Momentary stop of playback image
- Sound interrupted during playback, or abnormal sound
- Blue thumbnail display* (Fig. 1)
- Disc cannot correctly be recognized
- Disc cannot be initialized
- Delay between video and audio



Block noise

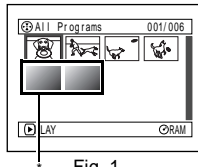
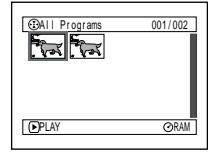

Fig. 1

Even if disc is normal, the above phenomena may occasionally occur. While the ACCESS/PC indicator is lit, do not subject disc to vibrations or impact, and avoid using DVD video camera/recorder at extremely high or low temperatures, or in environment where condensation is likely to occur.

- When recording images, the DVD video camera/recorder may avoid the portions of disc where recording is not possible, due to dust, scratches, etc. [It will pause ●II at such a portion and automatically restart recording (●REC).]



(Recording one scene may produce multiple thumbnails.)

This will cause recording to be interrupted for several seconds to several minutes, and multiple thumbnails will be created by one recording session as shown above. In this case, the recordable time on disc will decrease.

- Be careful when removing the disc since the metal of removal slot of DVD video camera/recorder, and disc itself, may be hot.

● Storing discs

- When storing disc, replace it in the plastic case in which it was purchased.
- Be careful that no condensation occurs on disc.
- Do not place disc in following places:
 - **Direct sunlight for a long time**
 - **Where humidity is high or in dusty place**
 - **While there is heat from a heater, etc.**

DISC CLEANING

Use the disc cleaning cloth provided to lightly wipe off any dirt adhering to the disc as shown in the figure. Do not wipe the disc with force: Doing so could cause scratches.

Never use solvent (thinner, water, antistat or detergent) for cleaning.

Lightly wash the dirty cleaning cloth with detergent: The dirt removal capacity of the cloth will improve (rinse the cloth well with water so that no detergent remains).

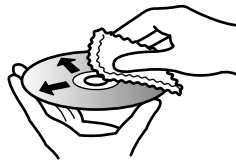

Use the disc cleaning cloth to clean from inner to outer edges in axial direction.

AVAILABLE CARDS

SD memory card can be used on this DVD video camera/recorder.

When using an exclusive adapter, a miniSD memory card can be used in the same way as an SD memory card.

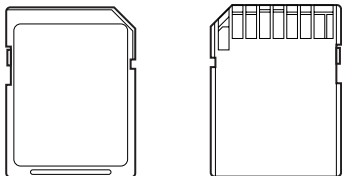

● Handling card

- Do not use cards other than the designated ones.
- Be sure to use a brand new card when recording vital images.
- Do not touch the card terminal or allow it to touch metal.
- Do not paste anything other than exclusive label on label pasting portion.
- Do not subject card to impact, bend or drop it.
- Do not disassemble card or modify it.
- Do not expose card to water.
- Do not use or store card in the following places:
 - Where the temperature is high, such as in vehicle at high temperatures, under burning sun or near a heater.
 - Where humidity is high, or in dusty place
- When the erasure prevention switch is locked, no recording, deletion or editing will be possible on the card: Only playback will be possible.

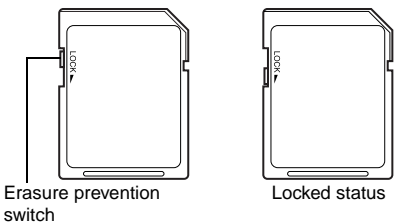
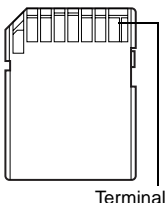

● Common cautions for disc and card

- It is recommended that you create a backup file for valuable data on hard disk of PC.
- Do not do the following, or the data on disc or card may be damaged or lost:
 - Do not remove the disc or card or turn DVD video camera/recorder off during reading or writing of data
 - Do not use DVD video camera/recorder in a place subject to static electricity or electrical noise
 - Do not have printing done at a print lab or DPE service.

Note:

- This DVD video camera/recorder can play back image data recorded on other digital cameras conforming to the DCF (Design rule for Camera File system) standard. The range of image data playable on this DVD video camera/recorder is that with pixels from 80 horizontal × 60 vertical to 4000 horizontal × 3000 vertical.
- DCF is an integrated image file format of digital cameras: Image files can be used on all digital devices conforming to DCF.
- Image data edited on PC and certain types of image data may not be visible on this DVD video camera/recorder.
- The image data recorded on another device may not be playable on this DVD video camera/recorder.

Storage Capacity on Disc or Card

RECORDABLE TIME OF MOVIE (VIDEO)

The recordable time will vary depending on the video recording quality: See page 91 for the setting of video recording quality.

Movie recordable time on one disc (on single side) (when recording only movies)

Recording quality	Movie recordable time	Application
XTRA	Approx. 18 min ^{*1}	Best quality
FINE	Approx. 30 min ^{*2}	High quality
STD	Approx. 60 min ^{*3}	Standard quality

^{*1}: Variable bit recording (recording of more than 18 minutes may be possible because the transfer rate varies automatically between approx. 3 – 10 Mbps)

^{*2}: Fixed bit rate: Approx. 6 Mbps

^{*3}: Fixed bit rate: Approx. 3 Mbps

Note:

- No movie can be recorded on SD memory card.
- Although the movie quality mode or wide-screen (16:9) mode can be changed midway for recording on DVD-RAM disc, it cannot be changed on DVD-R disc once the mode has been selected.
- If you record in XTRA mode at high temperatures, the DVD video camera/recorder will heat up and the maximum transfer rate will be limited to approx. 6 Mbps, so the best quality will not be obtainable.
- If a disc recorded is used at high temperatures, normal playback may be impossible: Turn the DVD video camera/recorder off once, wait until the ambient temperature becomes lower, and then operate it again.

RECORDABLE STILL (PHOTOS) ON DISC

● Number of recordable stills on one side of disc

DZ-GX20A: Can record up to approx. 750 photos.

DZ-MV780A/DZ-MV730A: Can record up to approx. 999 photos.

If the disc still has free space after recording the above maximum number of photos on it, movies can also be recorded on it.

RECORDABLE STILLS (PHOTOS) ON CARD

The number of recordable stills will vary depending on the recording quality: See page 94 for the setting of recording quality.

For DZ-GX20A

Recording quality	Capacity						
	16 MB	32 MB	64 MB	128MB	256 MB	512 MB	1 GB
FINE	Approx. 13	Approx. 29	Approx. 60	Approx. 120	Approx. 240	Approx. 480	Approx. 900
NORM	Approx. 18	Approx. 38	Approx. 80	Approx. 160	Approx. 320	Approx. 640	Approx. 1,200
ECO	Approx. 27	Approx. 58	Approx. 120	Approx. 240	Approx. 480	Approx. 960	Approx. 1,800

For DZ-MV780A

Recording quality	Capacity						
	16 MB	32 MB	64 MB	128MB	256 MB	512 MB	1 GB
FINE	Approx. 27	Approx. 58	Approx. 120	Approx. 240	Approx. 480	Approx. 960	Approx. 1,800
NORM	Approx. 36	Approx. 76	Approx. 160	Approx. 320	Approx. 640	Approx. 1,280	Approx. 2,400
ECO	Approx. 54	Approx. 116	Approx. 240	Approx. 480	Approx. 960	Approx. 1,920	Approx. 3,600

For DZ-MV730A

Recording quality	Capacity						
	16 MB	32 MB	64 MB	128MB	256 MB	512 MB	1 GB
FINE	Approx. 108	Approx. 232	Approx. 480	Approx. 960	Approx. 1,920	Approx. 3,840	Approx. 7,500
NORM	Approx. 216	Approx. 464	Approx. 960	Approx. 1,920	Approx. 3,840	Approx. 7,680	Approx. 15,000
ECO	Approx. 432	Approx. 928	Approx. 1,920	Approx. 3,840	Approx. 7,680	Approx. 15,360	Approx. 30,000

(The numbers of recordable stills above are only for reference)

Note:

- Cards used on other devices can be used on this DVD video camera/recorder.
- No movie or music data recorded on card can be checked, viewed or heard on this DVD video camera/recorder. In addition, no such a data file can be displayed on this DVD video camera/recorder.
- Use the remaining display function to check the remaining free space on disc before use. See "VERIFYING REMAINING FREE SPACE ON DISC OR CARD (CAPACITY)" on page 133.
- Some still data recorded on this DVD video camera/recorder may not be playable on another device.

SIZE AND QUALITY OF PHOTOS



The pixel size of stills (JPEG) that can be recorded on this DVD video camera/recorder is as follows:

Model	Setting	
	Camera input	External input
DZ-GX20A	1,600 × 1,200 pixels	640 × 480 pixels
DZ-MV780A	1,280 × 960 pixels	640 × 480 pixels
DZ-MV730A	640 × 480 pixels	640 × 480 pixels

The following table shows the file size and quality of one still (JPEG) recorded on card:

Quality	File size			Application
	DZ-GX20A	DZ-MV780A	DZ-MV730A	
FINE	Approx. 1,024 KB	Approx. 512 KB	Approx. 128 KB	When image quality is prioritized
NORM	Approx. 768 KB	Approx. 384 KB	Approx. 64 KB	Standard quality
ECO	Approx. 512 KB	Approx. 256 KB	Approx. 32 KB	When number of stills is prioritized (quality will be slightly inferior)



Although still images are recorded on DVD-RAM disc only in the FINE mode, the quality mode can be chosen when recording stills on card. (p. 94)

The file size of a photo recorded on DVD-RAM disc in “” status is equal to or larger than that recorded on card using the FINE quality in “”.

* JPEG: Joint Photographic Experts Group.

JPEG is one of the photo image compression standards. It is widely used in digital still cameras since JPEG files can be used on ordinary PC. When this DVD video camera/recorder records on DVD-RAM disc in “” status, a JPEG photo will be recorded, along with a photo that conforms to the DVD video recording (DVD-VR) format which is used to be output to TV (see “Terminology”, p. 155). Only JPEG photos will be recorded on SD memory card.

Note:

- No still can be recorded on DVD-R disc.
- Since the file size is restricted in all quality modes when recording photos on card (), the quality of photos on card may be inferior to those recorded on DVD-RAM disc ().

Setups

This section explains preparations for recording – setting up the DVD video camera/recorder and battery.

Setting Up the DVD Video Camera/Recorder

HOLDING DVD VIDEO CAMERA/RECORDER

Insert your right hand from the bottom of DVD video camera/recorder up to the base of your thumb.

Put your hand in a position where you can easily operate the REC button and the Zoom lever. Adjust the length of hand strap so that the DVD video camera/recorder is stable when you press the REC button with your thumb.

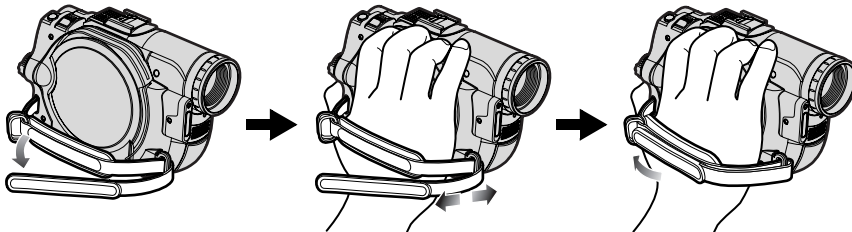

Note:

Do not adjust the hand strap while holding the DVD video camera/recorder: Doing this could cause the DVD video camera/recorder to fall and be damaged.

Caution:

Do not lift the DVD video camera/recorder by holding the viewfinder or LCD monitor: If the viewfinder or LCD monitor comes off, the DVD video camera/recorder will fall.

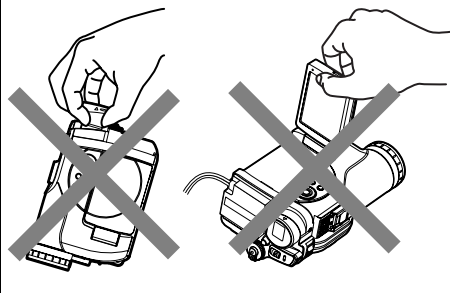

ATTACHING SHOULDER STRAP

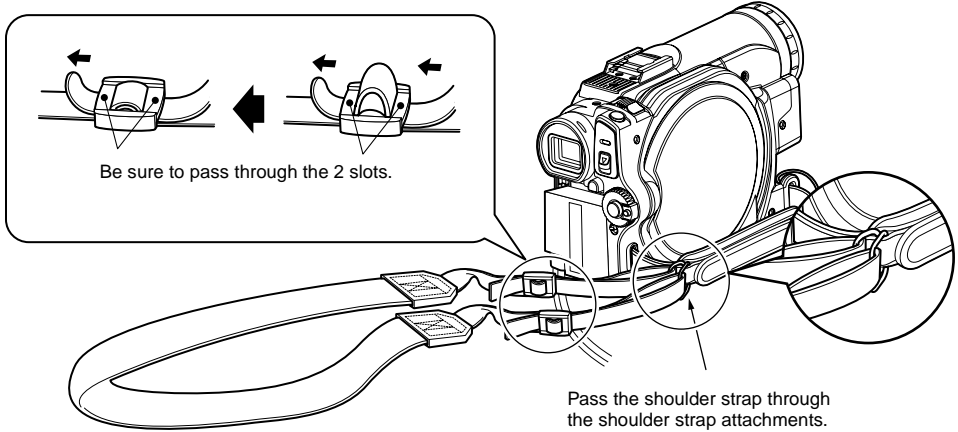

ATTACHING LENS CAP

- 1 Attach the shorter end of lens cap string to the lens cap.
- 2 Attach the longer end of lens cap string to the attachment hole of DVD video camera/recorder.
- 3 Push the both sides of cap inward and attach it over the lens.

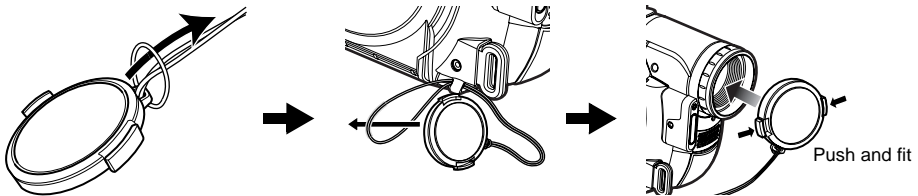
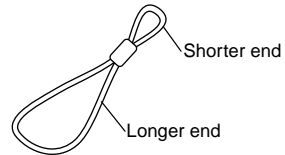

Note:

- Always keep the lens cap on when not using the DVD video camera/recorder, to protect the lens.
- When recording, attach the lens cap to the hand strap by hooking the tab inside the cap onto strap for comfortable shooting.

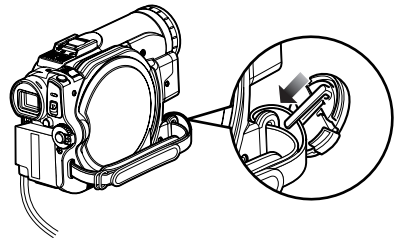

INSERTING BATTERY INTO REMOTE CONTROL

Insert the provided lithium battery into remote control.

1 While inserting a fine rod into the hole marked PUSH, pull the battery holder out forward.

2 Insert the lithium battery with the positive ⊕ terminal facing down.

3 Slide the cover to close it.

Note:

The life of lithium battery is approximately one year. If the battery is discharged, no operation is possible with remote control: Replace the battery.

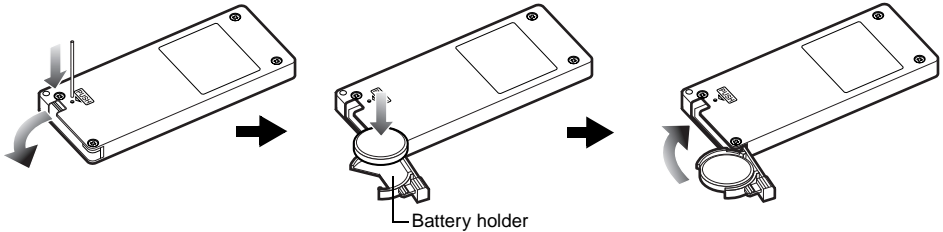

REMOVING BATTERY FROM REMOTE CONTROL

1 While pushing the battery holder, slide the battery out.

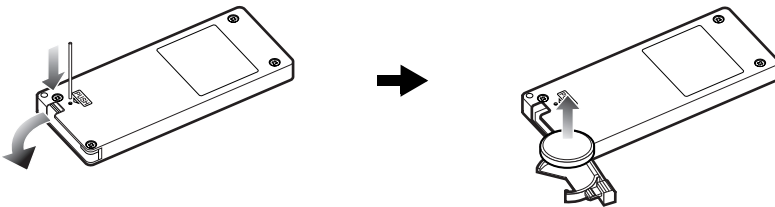

Warning:

- KEEP THE BATTERY AWAY FROM CHILDREN AND PETS.
- IF SWALLOWED CONSULT A PHYSICIAN IMMEDIATELY FOR EMERGENCY TREATMENT.
- BATTERY MAY EXPLODE IF NOT HANDLED PROPERLY. DO NOT RECHARGE, DISASSEMBLE OR DISPOSE OF IN FIRE.

Note:

- Replace the battery with a Hitachi Maxell, Sony, Panasonic, Sanyo, Toshiba CR2032, or Duracell DL2032. Use of another battery may present a risk of fire or explosion.
- Dispose of battery safely in accordance with local laws. Do not dispose of in fire.
- Do not short circuit the battery.
- Do not hold the battery with the metallic tweezers.
- Keep the battery in a dark, cool, dry place.
- The remote control (DZ-RM4W) and lithium battery (CR2032) are supplied only with the DZ-GX20A and DZ-MV780A.

● Using Remote Control

Point the remote control to the infrared receiver on the DVD video camera/recorder. The remote controllable distance is up to 16 feet (5 m).

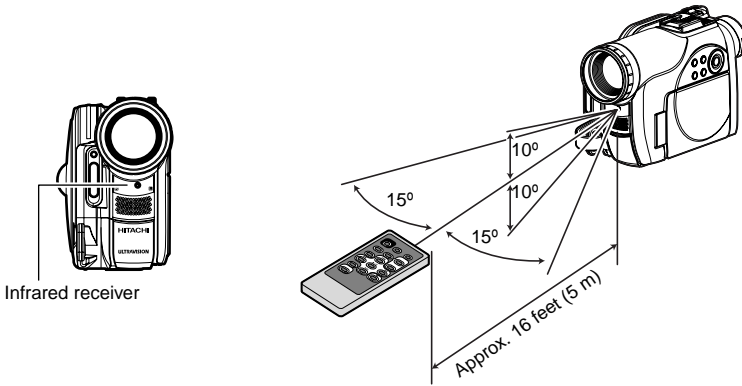

Note:

- When using the remote control, make sure that the infrared receiver on DVD video camera/recorder is not exposed to direct sunlight or any intense light. If the infrared receiver is subject to light stronger than the infrared light from remote control, the DVD video camera/recorder cannot be operated by remote control.
- If there is an obstacle between the remote control and infrared receiver on DVD video camera/recorder, remote control may not be possible.
- The DVD video camera/recorder uses the "VCR2" remote control code of Hitachi VCRs. If you use a Hitachi VCR, etc. with remote control code set to "VCR2", a VCR placed near the DVD video camera/recorder will also be operated by the remote control: To prevent this, change the remote control code of the VCR.
- The remote control (DZ-RM4W) and lithium battery (CR2032) are supplied only with the DZ-GX20A and DZ-MV780A.

VIEWING IMAGE ON LCD MONITOR SCREEN

If you open the LCD monitor, you can monitor subject image on the LCD screen.

1 Open the LCD monitor.

The LCD monitor has a portion where you can hook your finger. Hook the finger there to open the monitor.

● Range where the LCD monitor can be moved

The LCD monitor can be opened up to approximately 90°.

If the LCD monitor is open 90°, it can be tilted with the screen down as much as 90°, and can also be tilted with screen up and turned up to 180° so the screen faces in the same direction as the lens.

If the LCD monitor is turned 180° so the screen faces in the same direction as the lens during recording, subject image will also appear in the viewfinder as a mirror image (left/right reversed).

Tilt the LCD monitor to adjust its vertical angle so that you can see the screen easily.

Note:

- If no image appears on LCD monitor screen, refer to "Check 7" on page 159.
- If LCD monitor lights white, refer to page 87.
- Be sure to open the LCD monitor approximately 90° before changing its vertical angle.
- Do not record for a prolonged time with the LCD monitor turned approximately 180° in close contact with the DVD video camera/recorder body: Doing this could cause the DVD video camera/recorder and LCD monitor to become hot.

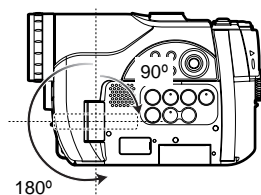
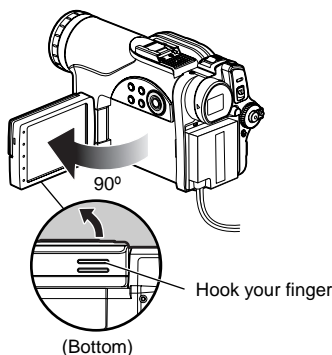

CLOSING LCD MONITOR

Before closing the LCD monitor, be sure to reset it at right angles to the DVD video camera/recorder.

Replace the LCD monitor on the DVD video camera/recorder with the LCD screen facing inward until a click is heard.

Note:

- Be sure to return the LCD monitor at right angles to the DVD video camera/recorder before closing it or replacing it on the DVD video camera/recorder with its screen facing outside. If the LCD monitor is tilted, it cannot be closed to the DVD video camera/recorder.
- If the LCD monitor is not securely locked to the DVD video camera/recorder, no image will appear in the viewfinder.

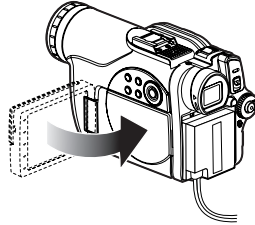

VIEWING SUBJECT THROUGH VIEWFINDER

1 Pull out the viewfinder.

2 Turn the diopter control knob to adjust the focus to suit your eyesight.

Note:

- If no image appears in viewfinder, refer to “Check 6” on page 159.
- If the LCD monitor is opened approximately 90°, the viewfinder will be off: Turn the open LCD monitor 180° so that it faces the same direction as the lens; the image will appear in the viewfinder.
- Focusing will not be correct unless the viewfinder is pulled out.
- See “LCD/EVF Setup” (on page 98) if you wish to display images in the viewfinder regardless of whether you open or close the LCD monitor.

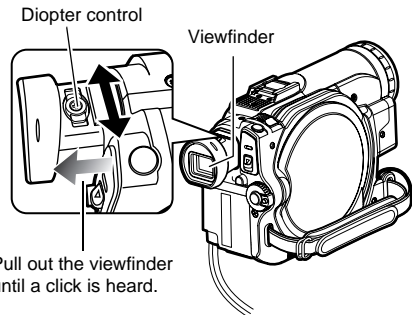

SETTING DATE AND TIME

Set the current date and time so that the date and time you make a recording can be recorded correctly.

The following procedure can also be used to correct the date and time you have already set.

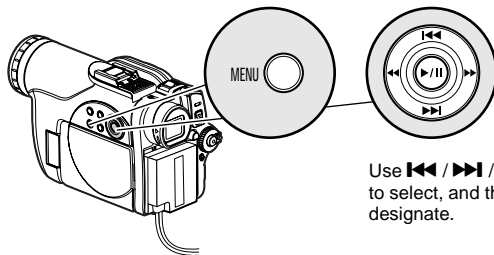

Use **◀◀ / ▶▶ / ◀◀ / ▶▶** buttons to select, and then press **▶/||** to designate.

1 Turn the DVD video camera/recorder on.

2 Press the MENU button.

The menu screen will appear.

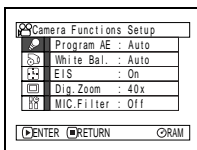

3 Use the **◀◀ / ▶▶ / ◀◀ / ▶▶** buttons to choose “Date Setup” and then “Date Set”.

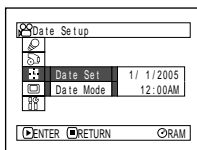

4 Press the **▶▶** button.

The figure for the month will be selected.

[The digit that is highlighted first depends on the date display format (set up in Date Mode): The digit on the left end of the date display will be first highlighted.]

Note:

After setting the figure for the month, press the **▶▶** button to right to select the digit to be set. If you press the **▶/||** button after selecting the figure for the month, the screen for verifying the set date will appear instead of screen for setting day, year or time.

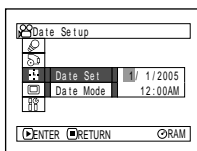

5 Press the **◀◀** or **▶▶** button to select the digit you want to set in sequence.

Press the **◀◀** or **▶▶** button to select the number for current date/time, and then repeat step 5 to set the current date and time.

Note:

To stop date/time setting midway, press the **■** button.

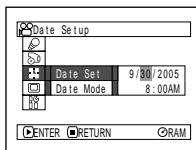

6 After setting the current date and time, press the **▶/||** button.

The screen for verifying the set date will appear.

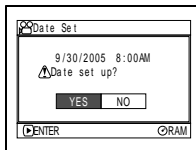

7 If the displayed date and time are correct, use press the **◀◀** button to choose “YES”, and then press the **▶/||** button.

The date and time will be set, and the DVD video camera/recorder will enter the recording pause status. Choosing “NO” will restore the menu screen.

Note:

This DVD video camera/recorder incorporates a rechargeable battery to store the date and time in memory. If this built-in battery is exhausted, the date and time will be reset. To prevent this, connect the AC adapter/charger to DVD video camera/recorder every 3 months, and leave them for at least 24 hours with the DVD video camera/recorder turned off: The built-in battery will be charged.

CHANGING DISPLAY FORMAT OF DATE AND TIME

You can select one of three date display formats: month/day/year, day/month/year or year/month/day. Associated with the selected date display, the time display format will also change as follows:

Date display format	Example of display
M/D/Y	5:00PM 9/30/2005
D/M/Y	17:00 30/ 9/2005
Y/M/D	PM 5:00 2005/ 9/30

1 Press the MENU button.

The menu screen will appear.

2 Use the **◀◀/▶▶/◀◀/▶▶** buttons to choose “Date Mode” on the “Date Setup” menu screen, and then press the **▶/||** button.

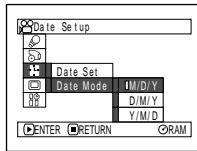

The options will appear on the right of “Date Mode”: The mark will be attached to the currently selected option.

3 Use the **◀◀/▶▶/◀◀/▶▶** buttons to select the desired date display format, and then press the **▶/||** button.

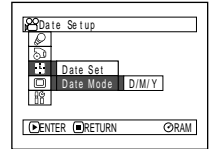

The menu screen for setting date will be restored, and the “Date Mode” has been changed as you designated.

4 Press the MENU button to switch off the menu screen.

Note:

If the date display format has been changed, the display format during playback as well as during recording will also be changed (see page 52).

Setting Up the Battery

The DZ-BP14S battery provided with DZ-GX20A or DZ-BP7S battery provided with DZ-MV780A and DZ-MV730A has not been charged at purchase time: Charge it before using the DVD video camera/recorder.

Note:

- Be sure to use the DZ-BP14S, DZ-BP7S, DZ-BP14SW (optional) or DZ-BP7SW (optional, unavailable for DZ-GX20A) battery for the DVD video camera/recorder: Using other batteries could cause the DVD video camera/recorder to malfunction, or result in fire.
- Be sure to use the DZ-ACS2 AC adapter/charger to charge the battery: Using other chargers could cause electric shock or fire.
- Charge the battery at temperatures of 50 – 86°F (10 – 30°C).
- If the CHARGE indicator does not light when the AC adapter/charger is plugged into AC outlet, unplug it from the AC outlet, wait a few moments, and then plug it into the AC outlet again. If the CHARGE indicator still does not light, the AC adapter/charger may be faulty. Unplug it from the AC outlet and consult your dealer.
- The AC adapter/charger can be used around the world. An AC plug adapter is required in some foreign countries. If you need one, purchase it from your local electronics distributor.

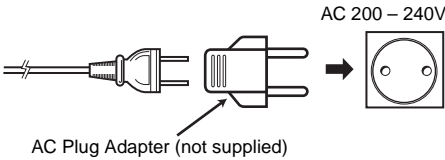

CHARGING BATTERY

Use the provided AC adapter/charger to charge the battery.

1 Connect the power cable to AC adapter/charger.

2 Plug the power cable into AC outlet.

3 Attach the battery to AC adapter/charger.

Note:

When charging a battery, unplug the DC power cord from the DC output jack on AC adapter/charger.

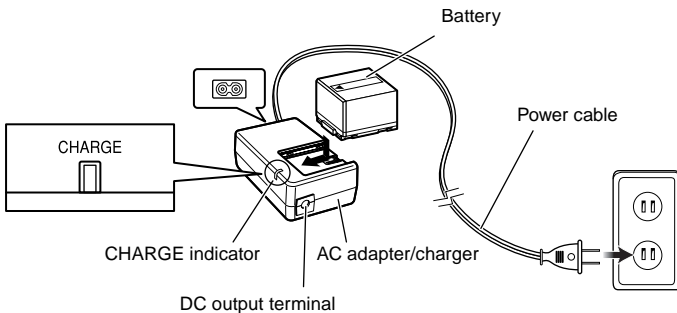

● Battery charged status

You can find out the charged status of battery by checking the CHARGE indicator on AC adapter/charger:

Charge status	CHARGE indicator
During charge	Lit
Charge complete	Goes out

Note:

See "Troubleshooting" on page 167 when the CHARGE indicator blinks.

● Reference for time required to charge battery (at approx. 77°F (25°C)):

DZ-BP14S (provided with DZ-GX20A)/DZ-BP14SW (optional): Approx. 165 minutes

DZ-BP7S (provided with DZ-MV780A and DZ-MV730A)/DZ-BP7SW (optional):

Approx. 90 minutes

The charge time will vary depending on the remaining power level of battery.

ATTACHING BATTERY TO DVD VIDEO CAMERA/RECORDER

- 1 Fit the battery to the battery attachment platform on this DVD video camera/recorder and slide it downward until a click is heard.

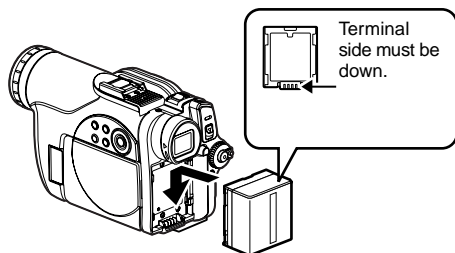

Note:

- Make sure that the battery is in the correct orientation.
- Make sure that the battery is securely attached: Incomplete attachment could cause the battery to fall, resulting in damage.

REMOVING BATTERY

After using the DVD video camera/recorder, remove the battery from it.

- 1 While holding down the BATTERY EJECT button, slide the battery upward to remove it.

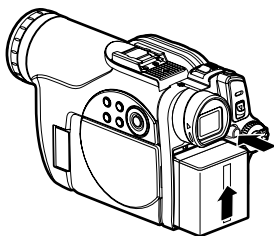

Note:

- For safety, be sure to turn the DVD video camera/recorder off before attaching or removing the battery.
- Be careful not to drop the removed battery.
- If the battery remains attached, minute level current will flow even if the DVD video camera/recorder is off, and the battery will discharge.

● **Continuously recordable time with fully charged battery (with no zoom operation, etc.)**

See the following table as a reference for how long the DVD video camera/recorder can continuously be used with a fully charged battery:

With DZ-BP14S (provided with DZ-GX20A)/DZ-BP14SW (optional)

Video mode		DZ-GX20A	DZ-MV780A	DZ-MV730A
XTRA*	When using viewfinder	approx. 125 min	approx. 145 min	approx. 170 min
	When using LCD monitor	approx. 110 min	approx. 125 min	approx. 145 min
FINE	When using viewfinder	approx. 125 min	approx. 145 min	approx. 170 min
	When using LCD monitor	approx. 110 min	approx. 125 min	approx. 145 min
STD	When using viewfinder	approx. 140 min	approx. 170 min	approx. 210 min
	When using LCD monitor	approx. 125 min	approx. 145 min	approx. 170 min

With DZ-BP7S (provided with DZ-MV780A and DZ-MV730A)/DZ-BP7SW (optional)**

Video mode		DZ-MV780A	DZ-MV730A
XTRA*	When using viewfinder	approx. 70 min	approx. 85 min
	When using LCD monitor	approx. 60 min	approx. 70 min
FINE	When using viewfinder	approx. 70 min	approx. 85 min
	When using LCD monitor	approx. 60 min	approx. 70 min
STD	When using viewfinder	approx. 80 min	approx. 100 min
	When using LCD monitor	approx. 70 min	approx. 85 min

* The time is only for reference: It will vary depending on recording contents.

**Unavailable for DZ-GX20A.

The reference for how long the DVD video camera/recorder can actually be used will be approx. 1/2 to 1/3 of the above time:

The continuously recordable time of DVD video camera/recorder in the above table shows the time available when the DVD video camera/recorder is in the recording mode without using any other function after recording is started. In actual recording, the battery will discharge 2 – 3 times faster than this reference, since the REC button and zoom are being operated, and playback is performed. Assume that the actually recordable time with a fully charged battery is between 1/2 and 1/3 of the above time, and prepare enough batteries to allow for the time you are planning to record on the DVD video camera/recorder.

The continuously recordable time may be less depending on the conditions when the DVD video camera/recorder is used (if recording and recording pause are repeated at short intervals, etc.).

Note that the battery discharges faster in cold places.

Note:

- See page 167 when charging is not possible.
- The charge time will vary depending on the battery remaining level.
- During and after charging, and when the DVD video camera/recorder is being used, the battery will be warm, but this does not indicate a fault.
- A battery cannot be charged while the DC power cord is connected to the DC output jack of AC adapter/charger: Unplug the DC power cord when charging a battery.
- Charge the battery at ambient temperature 50°F to 86°F (10°C to 30°C): Charging at temperatures other than this range could damage the battery.

BATTERY REMAINING LEVEL INDICATOR

When the battery is used to power the DVD video camera/recorder, the battery remaining level appears in the viewfinder or on the LCD screen as follows:

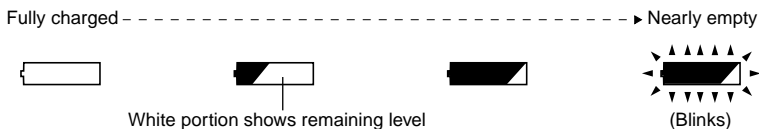

Note:

The remaining level indicator "□" may be displayed for an extended period, and "▤" or "▥" may be displayed for a shorter period.

If the remaining battery level runs out, the DVD video camera/recorder will automatically turn off. If this happens, be sure to set the power switch to "OFF" in order to remove the disc (see page 47).

EFFICIENT USE OF BATTERY

Charge battery immediately before using DVD video camera/recorder:

The battery will slightly discharge even if it is detached from the DVD video camera/recorder. If the battery is left attached to DVD video camera/recorder, it will consume a slight amount of power.

Therefore, it is recommended that you charge the battery shortly before using the DVD video camera/recorder, usually on the day before you plan to use it.

However, since the battery used for this DVD video camera/recorder is free from the memory effect, you do not need to completely discharge the battery before charging it.

When not using the DVD video camera/recorder for an extended period:

It is recommended that you fully charge the battery once a year, attach it to DVD video camera/recorder and use it up; then remove the battery and store it in a cool place again.

Store in cool, dark place:

When you are not using the DVD video camera/recorder, remove the battery and store it in a cool, dark place. If you store it in a place where the temperature is high, the battery life will be shortened. Be especially sure not to store the battery in an environment (in a closed vehicle) over 140°F (60°C): Neglecting this could damage the battery. Also, do not store the battery in a place which is too cold, such as in a refrigerator: Doing so could cause condensation when using the DVD video camera/recorder with the battery.

Battery life:

The battery life varies greatly depending on the ambient environment and how often the DVD video camera/recorder is used. If the usable time of DVD video camera/recorder with a fully charged battery is noticeably short, the battery is probably dead: Purchase a new one.

Power save and discharge of battery:

It is recommended that you turn the DVD video camera/recorder off in status other than recording, since even during recording pause battery power is consumed at the same level as during recording.

If, when you specify Power Save On, the recording pause status continues for approximately 5 minutes, the DVD video camera/recorder will automatically turn off. To set or release power save, see "TURNING DVD VIDEO CAMERA/RECORDER OFF AUTOMATICALLY (POWER SAVE)" on page 100.

USING DVD VIDEO CAMERA/RECORDER WITH AC ADAPTER/CHARGER

It is recommended that you use the AC adapter/charger to power the DVD video camera/recorder from household AC outlet when you perform settings on it, play back or edit images, or use it indoors.

Note:

Be sure to use the specified AC adapter/charger (DZ-ACS2) to power the DVD video camera/recorder. Using other AC adapter/chargers could cause electric shock or result in fire.

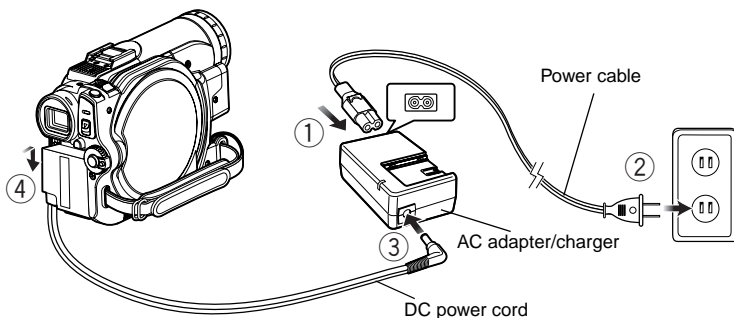

- 1 Connect the power cable to AC adapter/charger.
- 2 Plug the power cable into AC outlet.
- 3 Plug one end of DC power cord into the DC output jack on AC adapter/charger.
- 4 Attach the other end of DC power cord to the battery attachment platform on DVD video camera/recorder.

Turning DVD Video Camera/Recorder On and Off

While holding down the gray button at the right of power switch, set the switch according to each recording function:

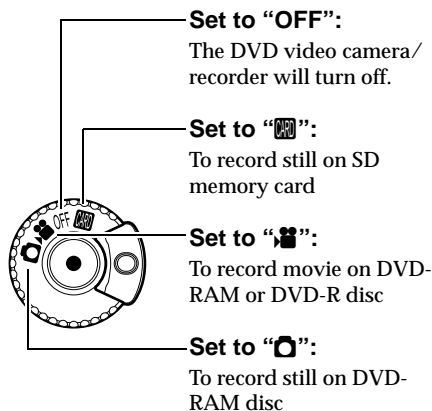

Power ON status

During playback, set the power switch to "DVD-RAM" or "DVD-RAM disc" when using disc, or set it to "SD" when using card.

Turn the switch while holding down the gray button at the right of switch.

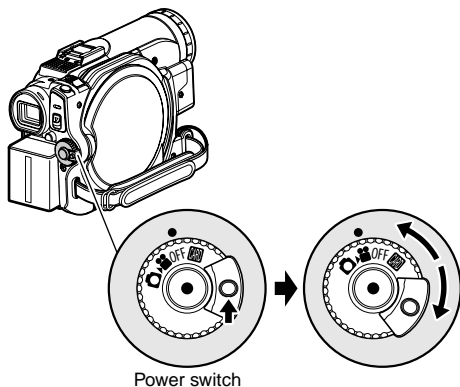

Note:

- Once you turn the DVD video camera/recorder on to let it recognize the disc, you can immediately record or play back by turning the DVD video camera/recorder on again. However, if a long time has elapsed after the disc was inserted, it will take some time for the DVD video camera/recorder to start because it must recognize the disc again (see page 158).
- It will take some time for the DVD video camera/recorder to display the Disc Navigation screen after power is turned on.
- If you turn the DVD video camera/recorder on, the ACCESS indicator will light or blink to show that the DVD video camera/recorder is recognizing the disc or card: During this time, no operation, such as recording, can be performed. After several seconds, the ACCESS indicator will go out, and operating the DVD video camera/recorder will be possible. If the ACCESS indicator does not go out, refer to "Check 4" on page 158.

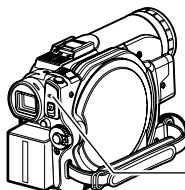

- When the DVD video camera/recorder is turned on, the self-diagnosis function will work and a message may appear. In this case, refer to "Trouble Messages" on page 160 and take corrective action.
- While the ACCESS/PC or CARD ACCESS indicator is lit or blinking, do not violently open or close the LCD monitor.

Inserting and Removing Disc

INSERTING DISC

- 1 Press down the DISC EJECT button once and release it.

A few moments after the ACCESS/PC indicator blinks, the cover of disc insertion block will open.

- 2 Gently open the cover by hand fully until it stops.

- 3 Push the disc against the turntable at the center to lock it until a click is heard.

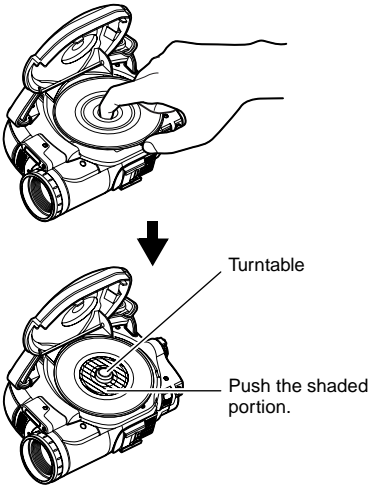

- Note that the recording surface of disc must face the inside of DVD video camera/recorder.
- Never touch the disc recording surface or pickup lens.

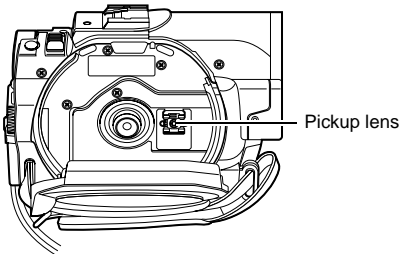

- Use the disc cleaning cloth provided to wipe off any dirt adhering to the disc recording surface.
- Do not use a dirtied or scratched disc.
- The recording side must face the inside (DVD video camera/recorder).

- 4 Push the section marked "PUSH CLOSE" on the cover of disc insertion block, to close the cover.

Then the DVD video camera/recorder will automatically recognize the disc: While the ACCESS/PC indicator is lit, do not cut off the power supply, and do not subject the DVD video camera/recorder to any vibrations or impact.

● Identifying recording sides of disc:

Single sided disc:

The recording side is opposite to the printed label.

Double-sided disc:

The recording side of "SIDE A" is opposite to the "SIDE A" marked side.

The recording side of "SIDE B" is the "SIDE A" marked side.

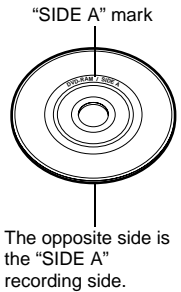

Note:

- If the cover of disc insertion block is open, the ACCESS/PC indicator will blink when an image is displayed on the LCD monitor screen: In this case, the DVD video camera/recorder will not turn off even if the power switch is set to "OFF".
If the cover remains open after a while, the DVD video camera/recorder will automatically turn off.
- Disc cannot be inserted or removed unless a charged battery or AC adapter/charger is connected to the DVD video camera/recorder.
- If a discharged battery is used, the disc cannot be inserted or removed: Connect a charged battery or AC adapter/charger to the DVD video camera/recorder.
- If there is some delay before recording starts, refer to "Check 4" on page 158.
- If the disc is not correctly attached to the turntable, it will be difficult to close the cover: If this happens, do not forcibly close the cover (this could cause a fault), but re-attach the disc to the turntable correctly.
- If a single-sided disc is inserted into DVD video camera/recorder with the printed label facing the inside, an error message will appear. Remove the disc and reinsert it with its recording side facing the inside. See "Trouble Messages" on page 160.
- **When using double-sided disc**
Recording is possible on both sides of double-sided disc. However, when recording or playback on one side is finished, recording or playback will not move automatically to the other side. Remove the disc once from the DVD video camera/recorder, turn over the disc and insert it again for continued use. The recording surfaces of double-sided disc are likely to become dirtied or scratched: Always make sure that there is no dirt or scratch on the recording surface facing the pickup lens, and then use the disc taking great care that it is not dirtied or scratched. Use the provided disc cleaning cloth to wipe off any dirt on disc (see page 26).

● When using brand-new DVD-R disc

Recognition of the disc will start.

The messages on the right will appear in sequence by pressing the ►/|| button between messages.

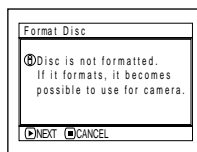

When recording on this DVD video camera/recorder:

When final message "Format the disc now?" appears, choose "YES" and then press the ►/|| button. The disc will be formatted.

When formatting is complete, "DVD-R disc, Video mode and 16:9 mode cannot be changed" will appear (see page 163): Press the ►/|| button to erase the message. Once formatted, a DVD-R disc can no longer be changed to a disc for PC, even if it has not been recorded on this DVD video camera/recorder.

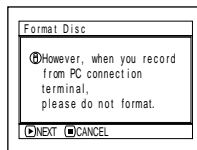

Not displayed on DZ-MV730A.

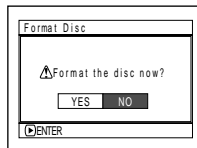

Note:

See page 91 for video mode.
See page 92 for 16:9 mode.

When recording data from PC (for DZ-GX20A or DZ-MV780A only):

While the above messages are being displayed, press the ■ button, or when message "Format the disc now?" appears, choose "NO" and then press the ►/|| button.

However, if data from PC has not yet been recorded, the disc can be made usable on this DVD video camera/recorder. When inserting the disc into this DVD video camera/recorder, the same message will appear: If you wish to use it on this DVD video camera/recorder, choose "YES".

Note:

Do not initialize a disc on which you wish to record data created using the application (DVDfunSTUDIO) of PC.

REMOVING DISC

- 1 Press down the DISC EJECT button once and release it.

In a moment, the cover of disc insertion block will open.

If the DVD video camera/recorder is on at this time, the "EJECT" indicator will blink on the LCD monitor or in the viewfinder.

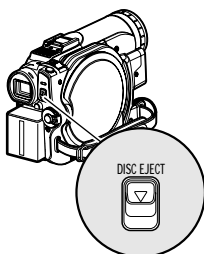

Note:

- Do not remove the battery or disconnect the AC adapter/charger during removal of the disc or until power is completely turned off: If you do, the disc cover will not open. If this happens, reattach the battery or AC adapter/charger, push down the DISC EJECT button once, and then release it.
- Do not insert anything other than the 8 cm DVD-RAM or DVD-R disc into the disc insertion block: Doing so could cause malfunctions.
- When inserting or removing the disc, BE SURE NOT to look into the lens in laser pickup: Doing so could damage your eyesight.
- If the battery remaining level runs out, set the power switch to "OFF" to remove the disc (see page 42).

- 2 Gently open the cover fully until it stops.

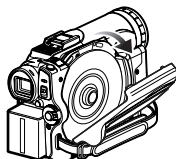

- 3 Remove the disc.

While pushing down the center portion of turntable, pick up the disc, holding its edge, to remove it.

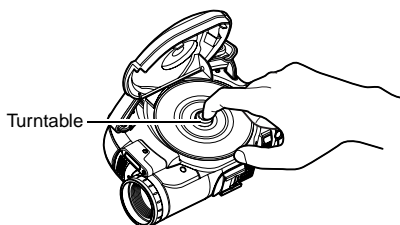

- 4 Gently push the section indicated "PUSH CLOSE" on the cover of disc insertion block, to close the cover.

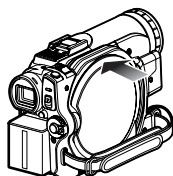

Inserting and Removing Card

- 1 Open the LCD monitor.
- 2 Turn the DVD video camera/recorder off.
- 3 Open the cover of card insertion block.

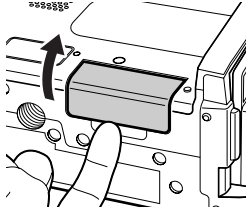

- 4 Inserting Card: Insert card with its terminal inward until it locks.

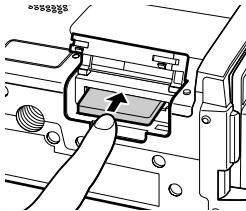
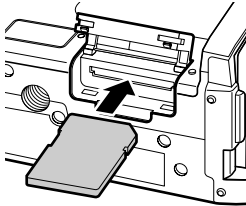

Removing Card:
Push the center of card edge.
The card will come out so that it can be held by fingers.

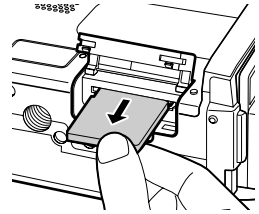
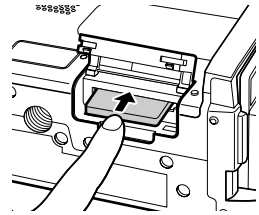

- 5 Close the cover of card insertion block.

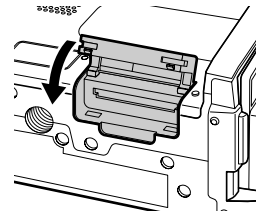

Note:

- No card is provided with this DVD video camera/recorder: Buy cards if you need them.
- See page 29 for the capacity of cards and the number of recordable photos on them.

Basic Techniques

This section explains about recording of movies and still images, and also basic settings on DVD video camera/recorder.

RAM R

Recording Movie

Before You Begin

- Insert a recordable DVD-RAM or DVD-R disc into this DVD video camera/recorder.

Pressing REC once will start recording; pressing it once again will temporarily stop recording.

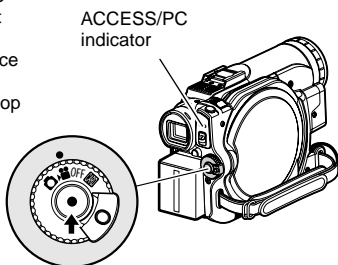

1 Remove the lens cap, and then point the DVD video camera/recorder at subject.

2 Turn the DVD camera/recorder on.

Set the power switch to “**●**” to turn the DVD video camera/recorder on.

After the ACCESS/PC indicator goes out, perform the subsequent operation:

3 Check the subject on the screen (viewfinder or LCD).

When using the viewfinder, close the LCD monitor before pulling out the viewfinder.

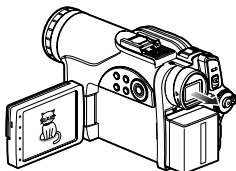

4 Press the REC button.

The “**●**” mark in the viewfinder or on the LCD screen will change to the “**● REC**” mark, and recording will start.

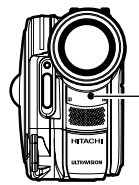

During recording, the recording indicator on the front of DVD video camera/recorder will light.

Pressing REC again during recording will set the DVD video camera/recorder to the recording pause status.



5 When recording is finished, turn the DVD video camera/recorder off.

Note:

- See "Check 1" on page 158 when recording movie is not possible.
- See "Check 4" on page 158 if it takes some time before recording is possible.
- See "Check 5" on page 159 if the DVD video camera/recorder does not operate.
- See page 52 for on-screen information display.
- It is recommended that you use DVD-RAM disc from which recorded contents can be deleted.
- Sound is recorded from the stereo microphone on the front of DVD video camera/recorder: Take care that this microphone is not blocked.
- You can press the REC button immediately after the DVD video camera/recorder enters the recording pause status, but no further recording can be made while "DISC ACCESS" is being displayed. Recording will restart after the message disappears.
- Do not turn power off while message "DISC ACCESS" is being displayed.
- Take care that power is not interrupted while the ACCESS/PC indicator is blinking.
- The minimum recordable time of movie is approximately 3 seconds.
- See page 101 for setting of Record LED (recording indicator) On/Off.
- For various functions available during recording, see "Setting Up Camera Functions" on page 86.
- Hitachi cannot be responsible for video and audio that cannot be recorded or edited because of any defect.
- The power switch can be changed over even during recording, but the operation will not be changed.
- Each time the DVD video camera/recorder enters the recording pause status, the counter display will be reset to "0:00:00".
- It is recommended that you set the LOCK switch to  (the upper position) to prevent the power switch in the  position from accidentally moving to  position.
- Do not insert a non-finalized DVD-R disc into another DVD device: Doing so could cause the disc to become unusable (except in the case of the devices that have a function that can play back a disc that has not been finalized on this DVD video camera/recorder).
- When using an unformatted DVD-R disc, it is necessary to format it on this DVD video camera/recorder (see page 46).

Recording Stills

Note:

Recording of still images is possible on DVD-RAM disc and card.

ACCESS/PC indicator

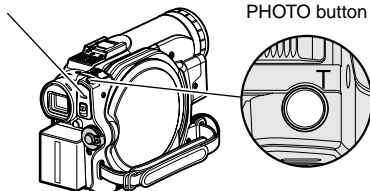
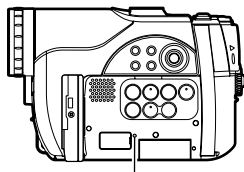

PHOTO button



CARD ACCESS indicator

1 Remove the lens cap, and then point the DVD video camera/recorder at subject.

2 Turn the DVD camera/recorder on.

When using DVD-RAM disc:

Set the power switch to “”.

When using card:

Set the power switch to “”.

After the ACCESS indicator goes out, perform the subsequent operation:

3 Check the subject on the screen (viewfinder or LCD).

When using the viewfinder, pull it out and close the LCD monitor.

4 Press the PHOTO button half way (half pressing).

The DVD video camera/recorder will automatically focus on the subject at the center of screen, and the “●II” indicator on screen will light in purple (the focus will not change when manual focus is chosen).

5 Press the PHOTO button all the way (full pressing).

The screen will be black, and then the recorded still will be displayed. When the “●II” mark appears, you can proceed with the next recording; while “DISC ACCESS” or “CARD ACCESS” is being displayed, you cannot proceed with the next recording.

Note:

- If you wish to record without locating a subject at the center of screen, first locate the subject at the center of screen, press the PHOTO button halfway down, determine the composition to be recorded, and then press the PHOTO button all the way down.
- If you press the PHOTO button all the way down at one stroke without pressing it half way, recording will be possible, but the focus will be incorrect.
- See “SIZE AND QUALITY OF PHOTOS” on page 30 for details of photos on card.
- See “Check 2” on page 158 if recording photos is not possible.
- Shake of the DVD video camera/recorder may cause blur in recorded image.
- When holding the DVD video camera/recorder for recording, grasp it securely with both hands.
- When recording with higher zoom magnification, it is recommended that you secure the DVD video camera/recorder on a tripod.
- Do not operate the power switch or remove the card while the ACCESS/PC or CARD ACCESS indicator is lit or blinking: Doing so may damage the card or the data on card.
- The range of screen in which recording is possible will be different for movie and still.
- If focusing is difficult with auto focus, choose manual focus, and manually correct the focus before recording (see page 72).
- There may be a difference between the image you see on the LCD screen or viewfinder and the recorded image.

On-Screen Information

Various types of information will appear in the viewfinder or on the LCD screen during recording.

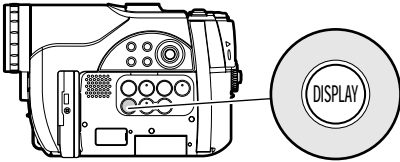

INFORMATION DISPLAY DURING RECORDING



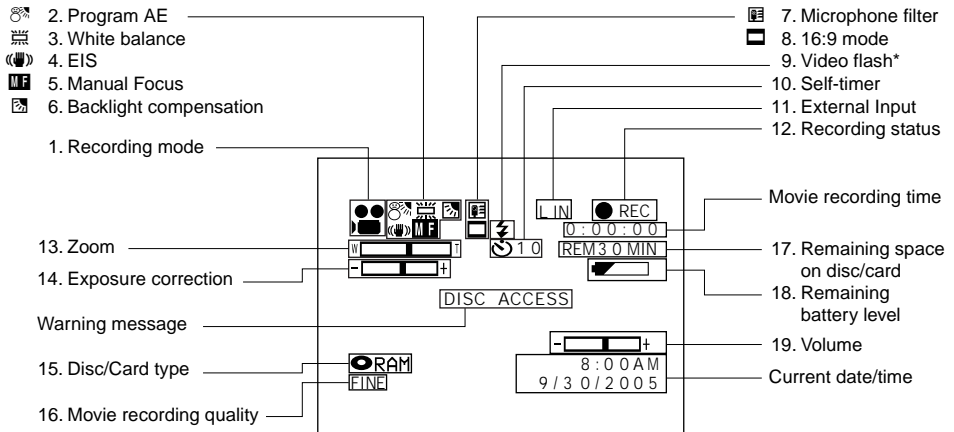



See the next page for details.



The above screen is an example for explanation:
It is different from the actual display.

*Not displayed on DZ-MV730A.





1. Recording mode (p. 49, 51, 95)

-  : Movie
-  : Still (Disc)
-  : External input still (field) (Disc)
-  : External input still (frame) (Disc)
-  : Still (Card)
-  : External input still (field) (Card)
-  : External input still (frame) (Card)

2. Program AE (only in movie recording mode) (p. 86)

- No display : Auto
-  : Sports
-  : Portrait
-  : Spotlight
-  : Sand & Snow
-  : Low Light



3. White balance (p. 88)

- No display : Auto
-  : Set
-  : Outdoor
-  : Indoor1
-  : Indoor2

4. Electronic image stabilizer (EIS)*1 (p. 90)

- No display : EIS OFF
-  : EIS ON

5. Manual focus (p. 72)

- No display : Autofocus
-  : (display in English or German): Manual focus
-  : (display in French or Italian): Manual focus
-  : (display in Spanish): Manual focus

6. Backlight compensation (p. 74)

- No display : Backlight compensation OFF
-  : Backlight compensation ON



7. Microphone filter (only in movie recording mode) (p. 90)

- No display : Microphone filter OFF
-  : Microphone filter ON

8. 16:9 mode (only in movie recording mode) (p. 92)

- No display : 16:9 mode OFF
-  : 16:9 mode ON

9. Video flash*2 [when Video Flash (sold separately) is attached] (only in still recording mode) (p. 76)

- No display : Emits light automatically
-  : Always emits light
-  : No light emission

10. Self-timer (only in still recording mode) (p. 96)

- No display : Self-timer OFF
-  : Self-timer ON
(countdown is from 10 seconds)

11. External Input (p. 95)

- L IN : AV input
- S IN*2 : S-VIDEO input

12. Recording status

- REC : During recording
- II : During recording pause (lights in green)
When focus locks during photo recording (lights in purple)

No display*3



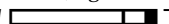
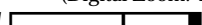



13. Zoom (p. 56)

- W  T
(Digital Zoom: Off)
- W  T
(Digital Zoom: 40×)
- W  T
(Digital Zoom: 240× only in movie recording mode)

14. Exposure correction

- No display : Auto
-  + : Manual

15. Disc/Card type

-  RAM : DVD-RAM
 -  R : DVD-R
 -  RAM : DVD-RAM (write-protected)
 -  F : DVD-R disc already finalized on this DVD video camera/recorder
 -  : DVD-R disc finalized on a device other than this DVD video camera/recorder
 -  : SD memory card
 -  : Locked SD memory card
- No display*4

16. Movie recording quality (when using disc) (p. 91)

- XTRA : Best quality
- FINE : High quality
- STD : Standard quality



Still recording quality (when using card) (p. 94)

- FINE : High quality
- NORM : Standard quality
- ECO : Number of recordable stills is prioritized

17. Remaining space on disc/card*5

- REM XX : Remaining recordable minutes
- MIN*6 : during movie recording
- REM XX*7 : Number of remaining recordable still images during still recording

18. Remaining battery level (p. 42)

-  (full charge)
-  ↓
 (low remaining charge)

19. Volume (p. 58)

-  + :
The volume can be adjusted during external input and playback.

*1 EIS cannot be used when recording photos on DZ-GX20A or DZ-MV780A.

*2 Not displayed on DZ-MV730A.

*3 When no disc or card is in the DVD video camera/recorder, or disc has not yet been initialized, a write-protected disc or locked card, or a disc or card with no remaining space, has been inserted.

*4 When a disc or card that cannot be used in this DVD video camera/recorder is inserted.

*5 No remaining time or number will be displayed with a protected disc or locked card, or finalized DVD-R disc.

*6 In XTRA mode, possible recording time may be longer than the displayed time.

*7 The displayed number of recordable stills is for reference: This number may not decrease, depending on the recording conditions (not displayed with a DVD-R disc).

● Switching the information display mode

You can switch the display mode of on-screen information:

Press the DISPLAY button.

The full and minimum display modes will alternate.

- **Full display mode:** All types of information will appear.
- **Minimum display mode:** The recording mode (see 1 on page 52) and recording status (see 12 on page 52) will appear. If the DVD video camera/recorder has warning information, a warning message will appear.

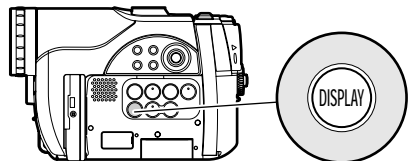

Note:

The DVD video camera/recorder does not record the date and time as a part of image. However, this information during recording will be recorded with image as data which can be checked on Disc Navigation screen during playback (see "INFORMATION DISPLAY DURING PLAYBACK" on page 62).

● Display when recording an image of yourself

When recording with the LCD screen facing the same direction as the lens, the operating status will appear: The battery remaining level will appear only when the remaining level is very low, and the display will blink.

The following operating status indicator will light or blink to give warning message to user. The message can be checked when returning the LCD monitor 180° to the original status from the status in which the LCD screen was facing the same direction as the lens.

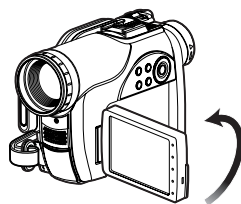

No warning/message (see page 52) will appear when recording with the LCD screen facing the same direction as the lens.

Instead, the following screen display symbols will blink to inform you of the operation status of DVD video camera/recorder.

When the LCD monitor is turned 180° from the position with the LCD screen facing the same direction as the lens, the warning/message can be checked.

● Interpreting symbols on LCD screen when recording with the screen facing the same direction as the lens:

Screen display symbol	Description
	<ul style="list-style-type: none"> A write-protected disc is loaded. A locked card is loaded.
	<ul style="list-style-type: none"> An unusable card is loaded.
	<ul style="list-style-type: none"> An attempt to record a still is being made with a DVD-R disc used. An unusable disc is loaded.
	<ul style="list-style-type: none"> During recording (lights in red). The remaining capacity on disc is approaching the limit 0 (blinks in red).
	<ul style="list-style-type: none"> During recording pause (lights in green). During focus lock (lights in purple). The remaining capacity on disc or card is approaching the limit 0 (blinks in red). There is no remaining capacity on disc or card (blinks in green). An attempt to record a copy-guarded image is being made (blinks in green).

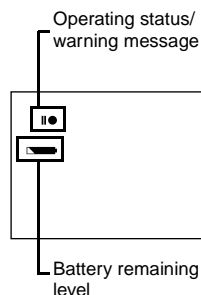

Note:

- If the LCD screen is set facing the same direction as the lens, the LCD screen will display a mirror image (left and right reversed).
- If the LCD screen is set facing the same direction as the lens, you can also view subject image in the viewfinder.
- Although you can switch to the manual focus, exposure and on-screen display modes even during recording with LCD screen facing the same direction as lens, they will not appear on the screen.
- When the LCD monitor is opened and turned 180° with the Program AE set to Low Light, the monitor screen will light white (see page 87).

Zooming

If you continue to hold the zoom lever on the “T” control side with Dig. Zoom 40× or 240× specified, the digital zoom will be activated midway (when optical 10-power is exceeded on DZ-GX20A or DZ-MV780A, or optical 16-power is exceeded on DZ-MV730A). You can zoom up to 240-power.

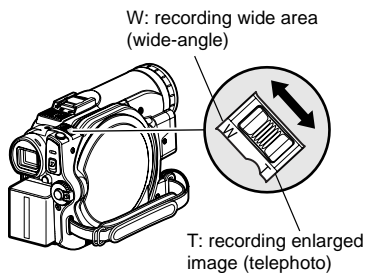

1 Press the MENU button, choose “Dig. Zoom” on the “Camera Functions Setup” menu screen, and then press the ►/|| button.

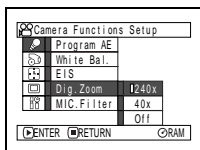

2 Choose the desired magnification, and then press the ►/|| button.

3 Press the MENU button to end the setting.

Moving the zoom lever will display the digital zoom bar.

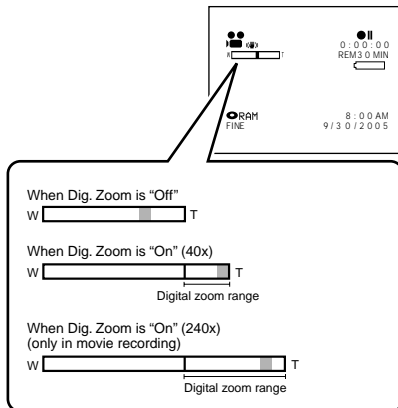

Note:

- The digital zoom setting will be stored in memory even if the DVD video camera/recorder is turned off.
- You can also use the DIGITAL ZOOM button on remote control to switch the digital zoom setting: Pressing the button during movie recording will switch the setting between “Off”, “40x”, and “240x”; Pressing the button during photo recording will switch between “Off” and “40x”.
- If you set zoom to “240x” when recording photo, the digital zoom will be up to 40x.
- When a subject is zoomed, it may be momentarily out of focus.
- When digital zoom is engaged, the image quality will be rougher.

MACRO RECORDING

Use the macro function when recording a small object from close-up position: You can shoot the subject as close as approximately 13/16" (2 cm) from the lens surface, magnifying the image to fill the screen.

- 1 Aim the DVD video camera/recorder at the subject, and press the zoom lever to "W" control side.

Note:

- Zoom can be used, but the subject may not be focused, depending on the distance to the subject. In this case, move the zoom to "W" control side to focus.
- The amount of light tends to be insufficient during macro recording: If the subject image is too dark, use additional lighting.

RECORDING SUBJECTS FOR STRONGER WIDE-ANGLE OR TELEPHOTO EFFECT

Use the tele-conversion lens or wide-conversion lens with the following filter diameter and thread pitch to record subjects for stronger telephoto or wide-angle effect:

Filter diameter: 34 mm for DZ-GX20A or DZ-MV730A; 30.5 mm for DZ-MV780A

Thread pitch: 0.5 mm

When attaching the optional DZ-TL1 tele-conversion lens or DZ-WL1 wide-conversion lens, use the optional step-up ring: DZ-SR3437 for DZ-GX20A or DZ-MV730A, DZ-SR3037 for DZ-MV780A (see page 151).

- 1 Remove the lens hood from DVD video camera/recorder, and attach the step-up ring over the lens.

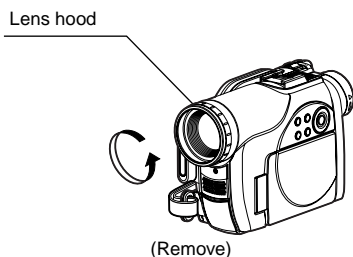

- 2 Remove the cap of conversion lens, and screw the lens into the thread of step-up ring.

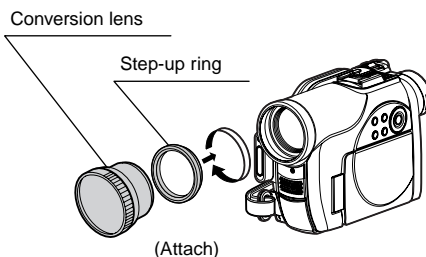

- Tele-conversion lens: For stronger telephoto effect
- Wide-conversion lens: For stronger wide-angle effect

Note:

- Be careful not to lose the removed lens hood.
- With DZ-TL1 tele-conversion lens, the focusing range at "T" (telephoto) control side is between approx. 16 feet (5 m) and infinite.
- When a conversion lens is attached, note that the four corners of screen will be slightly dim if you zoom in on a subject on the W control side (wide-angle side).
- When replacing the lens, take care not to drop the DVD video camera/recorder.
- Attaching the conversion lens will disable the function of the built-in flash (for DZ-GX20A only): Specify "Flash: Off" (see page 76).
- If a generally available filter is attached, do not attach the removed lens hood.

Playing Back

Before You Begin

- Insert a disc or card recorded on this DVD video camera/recorder (p. 49, 51).
- Turn the DVD video camera/recorder on (p. 44).

RAM R CARD

PLAYING BACK

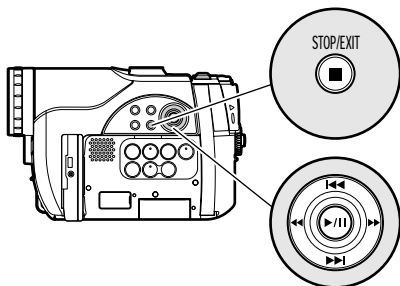

Use **◀▶** / **▶▶** / **◀◀** / **▶▶** to select, and then press **▶/||** to designate.

- 1** Press the **▶/||** button in the recording pause status.

The DVD video camera/recorder will enter the playback mode, and the scene you have recorded last will be played back. (For “scene”, see p. 103 and “Terminology”, p. 155.)

When playback is finished, the DVD video camera/recorder will enter the pause status at the last image on disc.

If the playback pause status continues for as long as 5 minutes, the DVD video camera/recorder will automatically return to the recording pause status.

- 2** Press the **■** button.

Playback will stop, and recording pause status will be restored.

Note:

- If the LCD monitor is open during playback of movie, playback sound will be heard from the speaker. Adjust the sound volume using the volume control buttons (⊖, ⊕).
- To temporarily stop playback, press the **▶/||** button. Press the **▶/||** button again to restart playback.
- Even if you stop playback midway and immediately start recording again, the new image will be recorded after the last scene on disc or card (the previous images will not be overwritten).
- Image data edited on PC, etc., or the recorded image may not appear on this DVD video camera/recorder; also, the recorded sound may not play back, depending on the type of image data.
- Image data recorded on another DVD video camera/recorder or DVD recorder may not be played on this DVD video camera/recorder.
- Depending on the amount of data to be played back, it may take some time for the playback image to appear.
- Do not operate the power switch or remove the card while the ACCESS/PC or CARD ACCESS indicator is lit or blinking: Doing so may damage the card or the data on card.

PLAYBACK FROM START OF DISC OR CARD

Use the Go To function (p. 61) or Disc Navigation function (p. 103) to play back from the start of disc or card.

SEARCH PLAYBACK OF MOVIE

During playback, press the ◀◀ or ▶▶ button and hold it: Search playback will start.

Hold down ▶▶ :

Scenes will be visually scanned forward.

Hold down ◀◀ :

Scenes will be visually scanned backward.

Release the ◀◀ or ▶▶ button when you find the desired image:

Normal playback will start from that point.

Note:

- See page 158 if search playback does not operate normally.

FRAME ADVANCE/FRAME BACK/SLOW PLAYBACK OF MOVIE

During playback pause, press the ◀◀ or ▶▶ button: Frame advance, frame back or slow playback will start.

Press ▶▶ once:

Picture will advance one frame.

Press ◀◀ once:

Picture will go back one frame.

Hold down ▶▶ :

Forward slow playback.

Hold down ◀◀ :

Reverse slow playback.

After frame advance, frame back or slow playback, the DVD video camera/recorder will enter the playback pause status.

Note:

- In slow playback, a rapidly moving subject image may be distorted.
- The intervals for playing back frames in frame advance/frame back/slow playback are as follows:
Frame advance and forward slow: Approx. 0.03 second
Frame back and reverse slow: Approx. 0.5 second
- No sound will be heard during search playback or slow playback.

SKIP PLAYBACK OF MOVIE

During playback, press the **⏮** or **⏭** button to locate the start of desired scene.

Press **⏭** once:

To skip to the first image of the scene following the one being played back, and start playback.

Press **⏮** once:

To return to the first image of the scene being played back, and start playback.

Hold down **⏭**:

To continuously locate the beginnings of scenes, starting from the scene following the scene being played back. When the desired image appears, release the button: Playback will start from that point.

Hold down **⏮**:

To continuously locate the beginnings of scenes backward, starting from the scene preceding the scene currently being played back. When the desired image appears, release the button: Playback will start from that point.

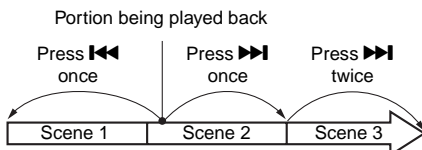
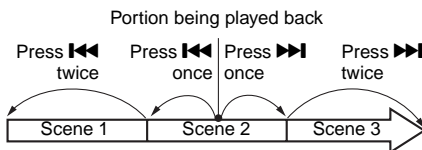

Pressing the **⏮** button at a portion several seconds from the start of scene being played back will return to the start of the scene preceding that being played back.

Note:

- If you perform skip playback during playback pause, the DVD video camera/recorder will enter the playback pause status at the beginning of the located scene.
- Pressing the **⏭** button in the last scene on disc will set the DVD video camera/recorder to the playback pause status at the last image.
- See "Check 3" on page 158 if skip playback does not operate normally.

PLAYING BACK STILLS

Press the **⏮** or **⏭** button during playback to quickly play back stills in sequence.

Press **⏭** once:

To display stills one by one forward.

Press **⏮** once:

To display stills one by one backward.

[When using disc]

Releasing the **⏮** or **⏭** button will start continuous playback.

[When using card]

When the **⏮** or **⏭** button is released, the photo at that point will be displayed, and then the DVD video camera/recorder will enter the playback pause status.

Set the slide show function for continuous display (p. 137).

JUMPING TO SPECIFIED POINT (GO TO)

1 Press the MENU button during playback.

2 Choose the option (point you want to go to), and then press the ►/|| button.

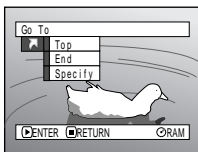

Top:

To go to the start, and enter playback pause.

End:

To go to the end of last scene, and enter playback pause.

Specify:

To go to a specified point and enter playback pause. See the following for details.

● Specifying the point to view

1 Choose “Specify” in step 2 above, and then press the ►/|| button.

The screen for specifying the point to go to will appear.

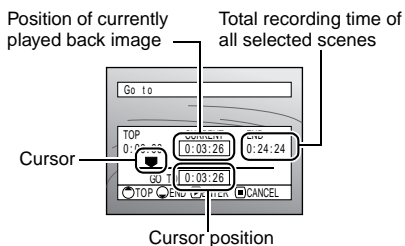

2 Use the ◀◀/▶▶/◀/▶ buttons to select the desired time of chosen point.

Press ◀◀ : To select the start.

Press ▶▶ : To select the end.

Press ◀ or ▶ :

- Press once:

To move the cursor in 10-second units (1-still units for card)

- Hold down:

To move the cursor in 1-minute units (10-still units for card)

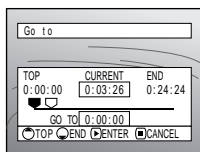

(When the start of scene is selected)

☐ Cursor at current image position.

☑ Cursor at (GO TO) position.

3 Press the ►/|| button to enter the selection.

The DVD video camera/recorder will go to the specified point and enter the playback pause status.

Pressing ►/|| again will start playback.

To cancel the “Go To” procedure midway, press the ■ button before going to the specified point.

Note:

- If multiple scenes are selected using the Disc Navigation function or SELECT button, choosing “Top” will jump to the beginning of selected scenes (p. 131).
- When multiple scenes are selected, the total time of selected scenes will appear in the “total recording time” display.
- With card, the number of stills will appear at the “TOP”, “CURRENT”, “END” and “GO TO” indicators.
- The cursor may not move at same-pitch intervals.

On-Screen Information Display

INFORMATION DISPLAY DURING PLAYBACK

Various types of information on recording will be superimposed on playback image you are viewing.

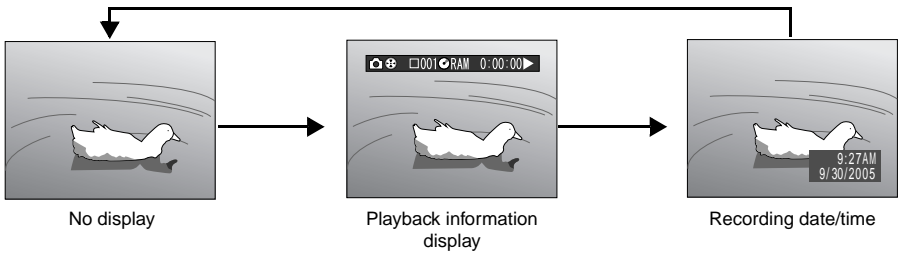

● Switching the information display mode

Press the DISPLAY button: You can switch the display mode of on-screen information.

When using disc:

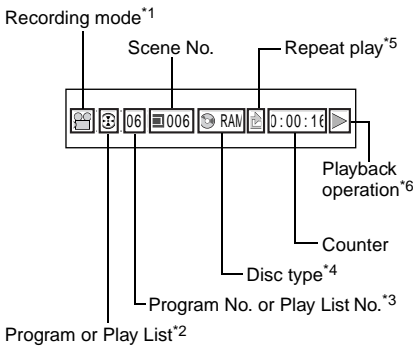

When using card:

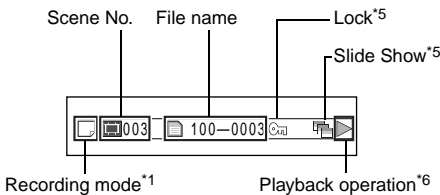

- *1 (VIDEO) or (PHOTO) with disc; Only (PHOTO) with card.
- *2 Program or Play List
- *3 Number of program or play list being played back (not displayed when all programs are being played back)
- *4 Refer to "Disc/Card type" on page 54.
- *5 : Will appear when each function is specified "On"
- *6 : Standard playback
 : Playback pause
 : Forward search playback
 : Reverse search playback
 : Forward skip playback
 : Reverse skip playback
 : Forward frame advance
 : Reverse frame back

Refer to "Playing Back" beginning on page 58 for how to operate.

The "◀" mark will appear on the first image on disc.

The "▶" mark will appear on the last image on disc.

- **Recording date/time display:** Shows the date/time when recording was started. Even when playback starts, the date/time display will not advance.
- **No display:** No information will appear. However, when the mode of playback operation is switched, the symbol will appear for approx. 3 seconds.

Note:

See "Using Disc Navigation" on page 103 and later for explanation on program and play list.

Checking Flow of Quick Menu

The following two on-screen menu modes are available with this DVD video camera/recorder:

- Quick Menu: To display only the fundamental menu items for first timers
- Normal Menu: To display all menu items for experts (p. 84)

Camera Functions

While the camera image is being displayed on the LCD monitor, press the QUICK MENU button: The Quick Menu will appear.

Only the fundamental menu items will appear in the Quick Menu, and the explanation of the function on which the cursor is positioned will be displayed across the bottom of menu (No explanation on function will appear in the Normal Menu.).

Use the **◀◀/▶▶/◀▶/▶▶** buttons to select a menu item, and then press the **▶/||** button to choose the option.

See "Operating Menu" shown below for how to set the menu.

No menu appears during recording.

1 Press the QUICK MENU button.

<How to interpret the menu screen>

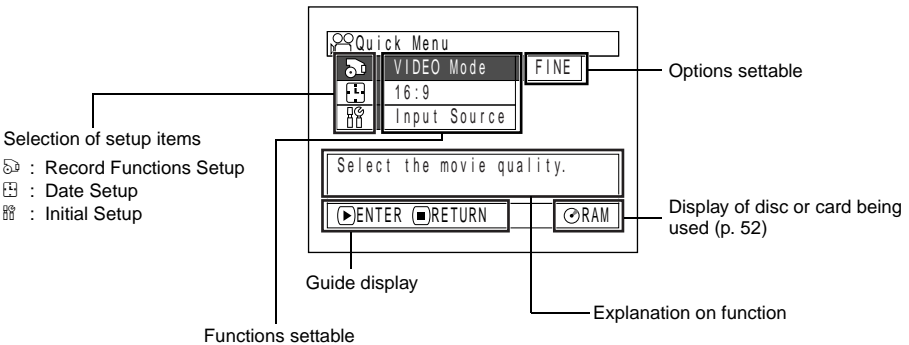

● Operating Menu

You can use the **◀▶/▶▶/◀◀/▶▶▶▶** buttons on DVD video camera/recorder to select various setting options in Quick Menu and designate them.

Press the QUICK MENU button.

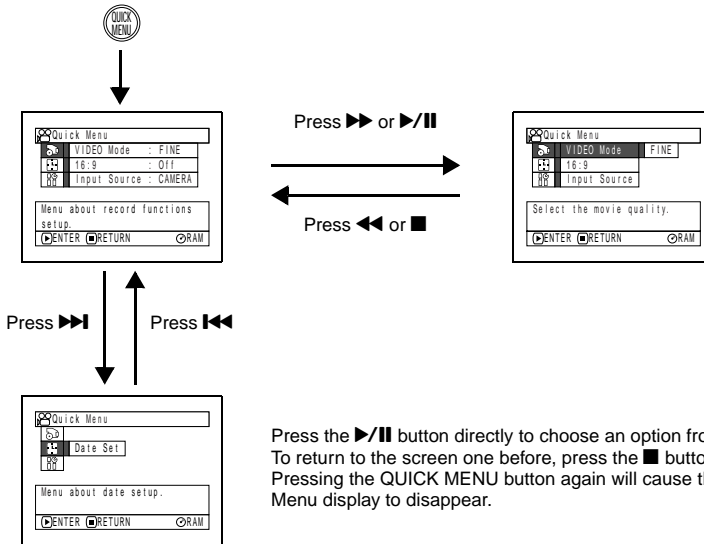

When using the Normal Menu (p. 85) and Disc Navigation Menu (p. 108), use the same procedure to choose any menu item and determine the option.

Note:

- Pressing the QUICK MENU button during recording will not work.
- The menu screen will disappear when it is left for approx. one minute without any operation.

FLOW OF QUICK MENU WHEN RECORDING MOVIE:

The following shows the menu when DVD-RAM disc is being used:
 The details of each function are described on the pages showing the Normal Menu: See each reference page.

●Record Functions Setup

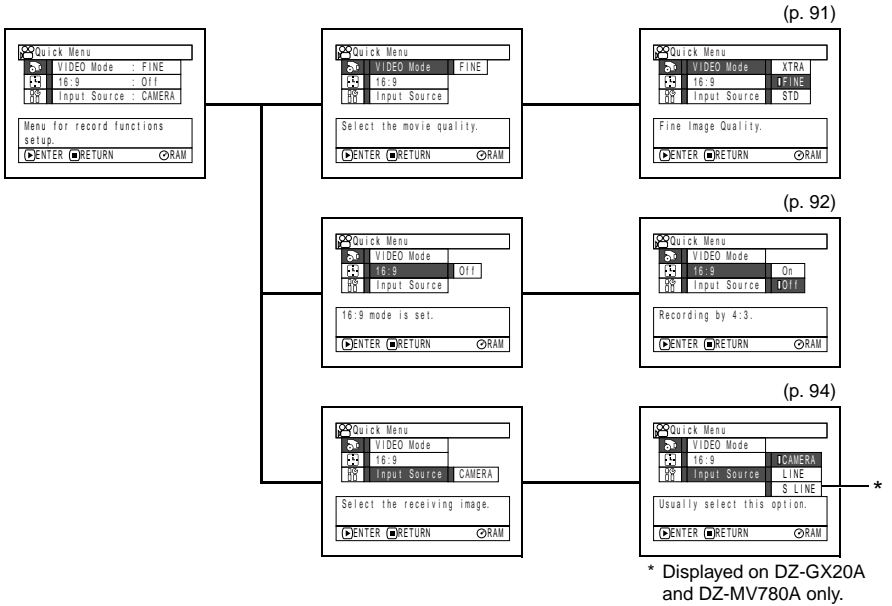

●Date Setup

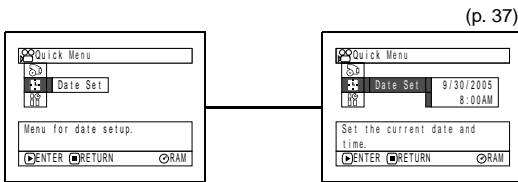

● Initial Setup

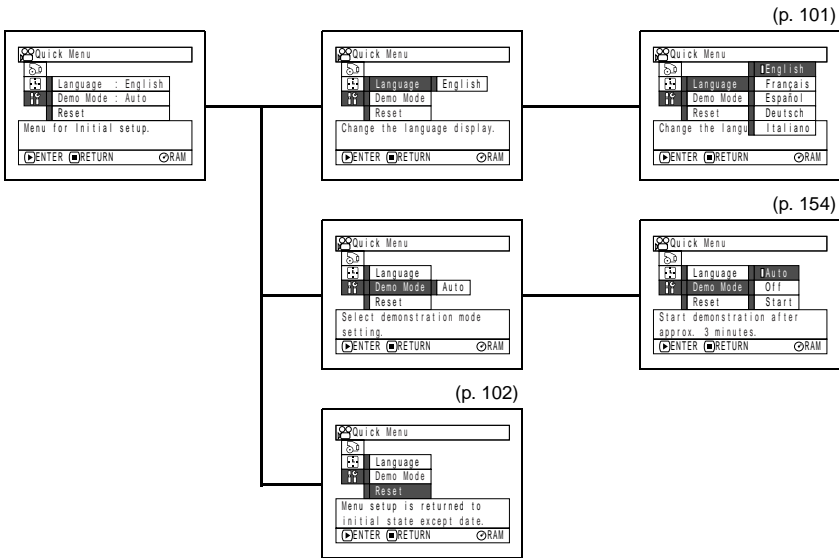

RAM

FLOW OF QUICK MENU WHEN RECORDING PHOTO (DISC):

The following shows the menu when DVD-RAM disc is being used:

The details of each function are described on pages showing the Normal Menu: See each reference page.

● Record Functions Setup

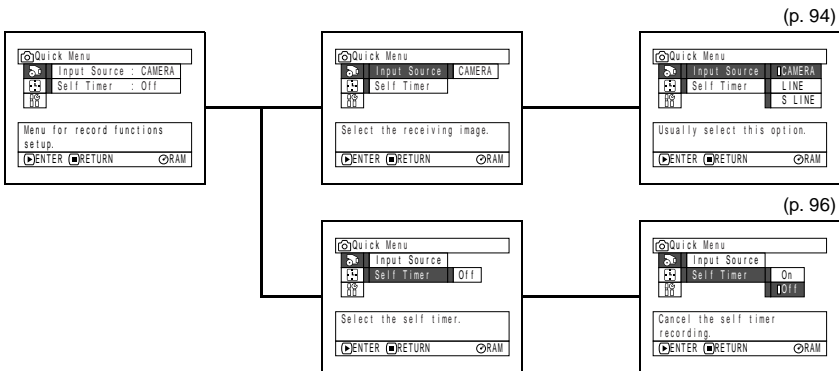

● Date Setup

(p. 37)

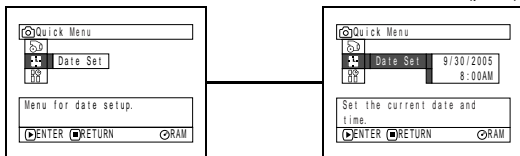

● Initial Setup

(p. 101)

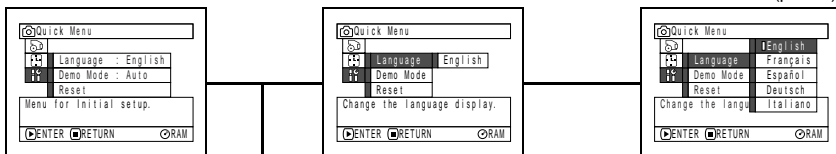

(p. 154)

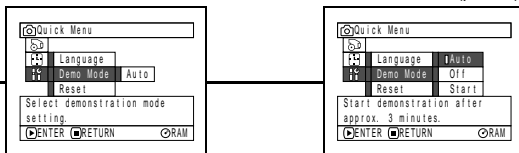

(p. 102)

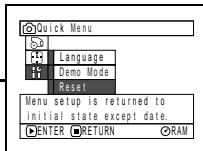

Note:

No photo can be recorded on DVD-R disc.

FLOW OF QUICK MENU WHEN RECORDING PHOTO (CARD):

The details of each function are described on pages showing the Normal Menu: See each reference page.

● Record Functions Setup



● Date Setup

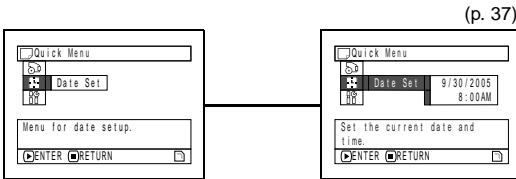

● Initial Setup

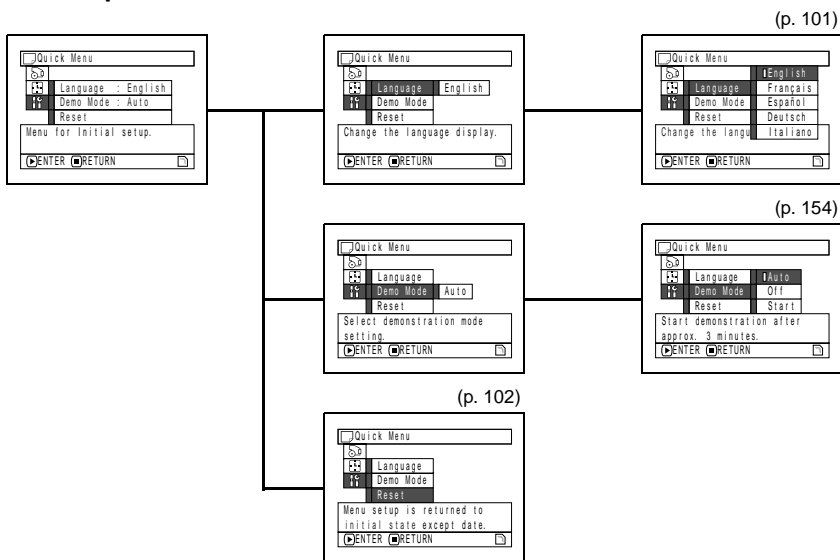

Disc Navigation Functions

While Disc Navigation screen is being displayed on the LCD monitor, press the QUICK MENU button: The Quick Menu will appear.

Only the fundamental menu items will appear in the Quick Menu, and the explanation of the function on which the cursor is positioned will be displayed across the bottom of menu (except during recording).

- 1 Press the DISC NAVIGATION button.
- 2 Select a scene, and then press the QUICK MENU button.

FLOW OF QUICK MENU (WITH DVD-RAM DISC):

The details of each function are described on pages showing the Normal Menu: See each reference page.

● Scene

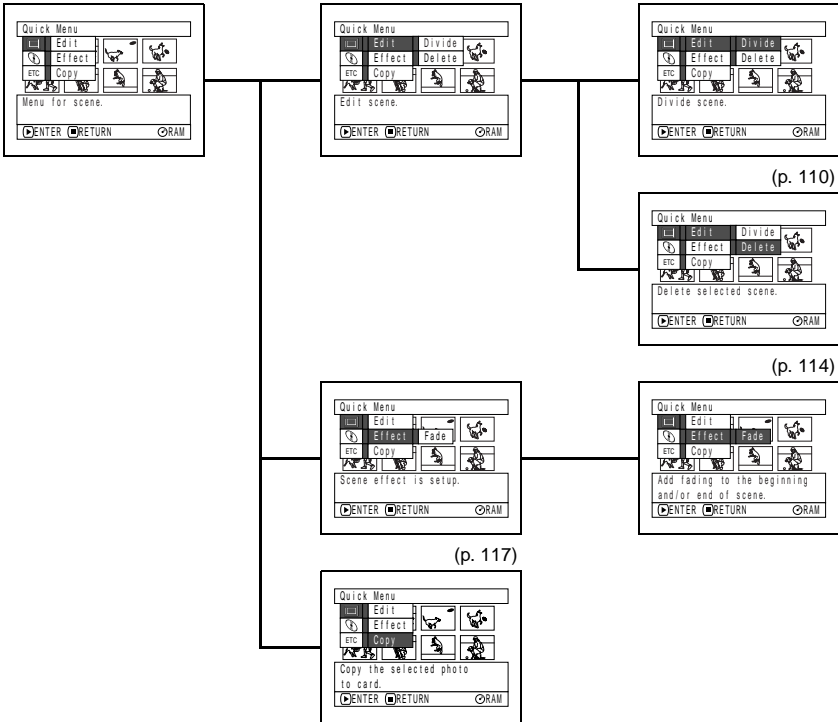

● Disc

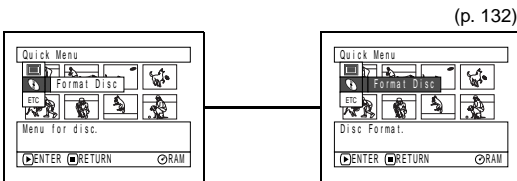

● Others

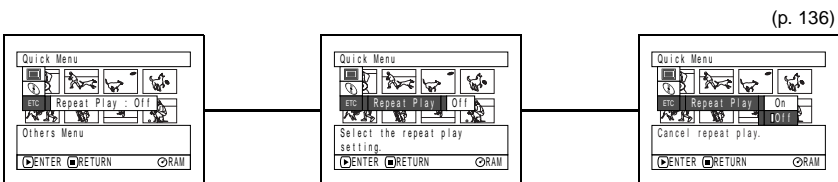

FLOW OF QUICK MENU (WITH DVD-R DISC):

The details of each function are described on pages showing the Normal Menu: See each reference page.

● Disc

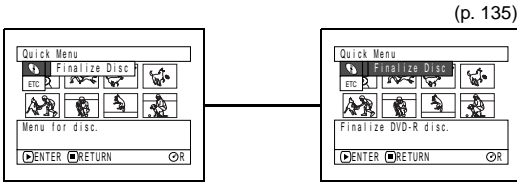

● Others



Note:

The menu item "Finalize Disc" will not appear with a finalized DVD-R disc.

FLOW OF QUICK MENU (WITH CARD):

The details of each function are described on pages showing the Normal Menu: See each reference page.

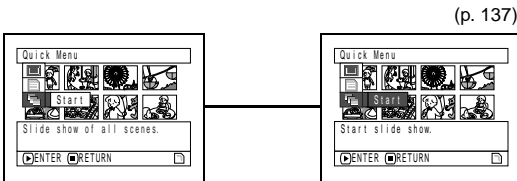
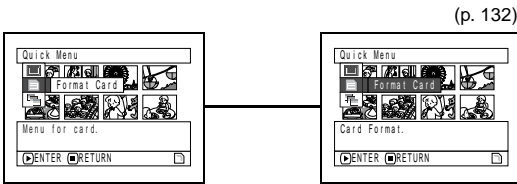
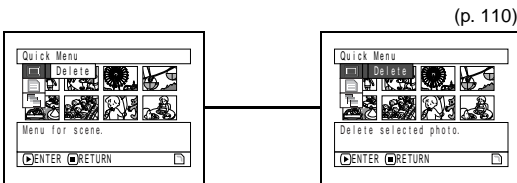

Manually Focusing Subject

The DVD video camera/recorder usually focuses on a subject automatically (autofocus). You can also manually focus a subject depending on the recording conditions.

FOCUSING DURING RECORDING

Normally, the DVD video camera/recorder automatically focuses the subject (auto-focus), but you can also manually focus a subject, depending on the recording conditions (manual focus).

Focusing range

You can switch the display mode of on-screen information:

- On T (tele) side: approximately 3.2 feet (1 m) from lens surface to infinity
- On W (wide) side: approximately 13/16" (2 cm) from lens surface to infinity

1 Press the FOCUS button during recording.

"MF" will appear on the screen.

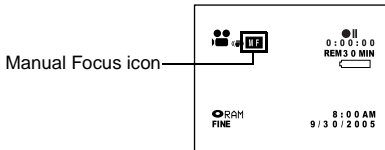

2 Press the zoom lever to "T" control side to zoom in on subject.

3 Use the ⊖ ⊕ buttons to adjust the focus, while viewing the image in the viewfinder or on the LCD screen.

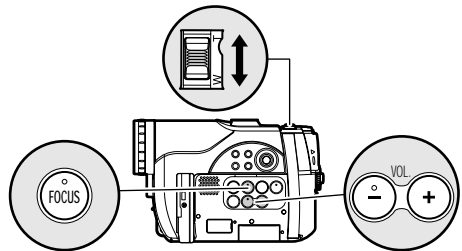

Adjust with ⊖ and ⊕ buttons

Note:

- Pressing FOCUS will alternate between manual focus and auto focus. With auto focus, no indication will appear on the screen.
- Be sure to zoom in on your subject before manually focusing on it. If you bring the subject into focus at the "W" control side, focus will be faulty when you turn the zoom lever to the "T" control side to zoom in on the subject.
- Manual focus is released when the DVD video camera/recorder is turned off. When you turn the DVD video camera/recorder on next time, auto focus will be restored.

Manually focus the following objects, which may not be automatically focused (see page 72):

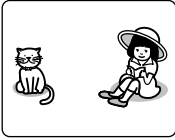

Objects not in the center of screen

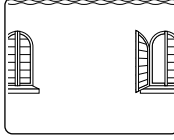

Objects with little variation in brightness, such as white wall



Objects that are far and near at the same time



Objects moving rapidly



Objects lit by neon sign, spotlight, etc. which glares or emits strong light



Dark objects



Object behind glass with water droplets, dirt on it



Night view

Adjusting Brightness of Image to be recorded (Exposure)

The DVD video camera/recorder usually adjusts the exposure automatically. You can also manually adjust the exposure depending on the recording conditions.

- 1 Press the EXPOSURE button during recording.

The exposure adjustment bar will appear on the screen.

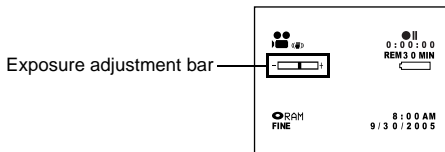

- 2 Use the \ominus \oplus buttons to adjust the exposure, while viewing the image in the viewfinder or on the LCD screen.

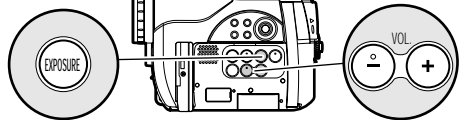

Adjust with \ominus and \oplus buttons

Note:

- Pressing EXPOSURE will alternate between manual adjustment and auto exposure. With auto exposure, no indication will appear on the screen.
- The exposure setting will return to Auto when the DVD video camera/recorder is turned off.

Compensating for Backlight

When subject is lighted from rear, this function will compensate for lighting so that the subject is not too dark.

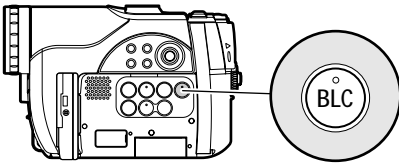

- 1 Press the BLC button during recording.

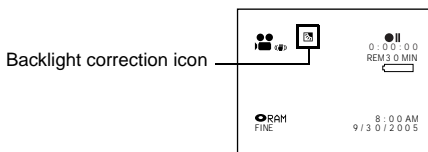

The backlight correction icon will appear.

Note:

- Pressing the BLC button will alternate between backlight setting between on and off.
- The backlight setting will automatically return to "off" when the DVD video camera/recorder is turned off.

Using External Microphone

Connect external microphone (generally available) to the external microphone jack of this DVD video camera/recorder. Clearer sound can be recorded. Turn on the switch on external microphone and start recording. For details on external microphone, see “Major Specifications” on page 175.

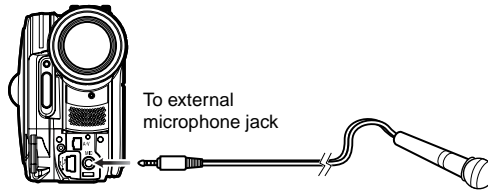



Note:

- Depending on the shape of its plug, an external microphone cannot be plugged in, while the cable is left plugged in the AV/S input/output terminal. Unplug the AV/S input/output cable to use the external microphone.
- This DVD video camera/recorder cannot use a plug-in power type microphone. (Power is not supplied from this DVD video camera/recorder.)

Built-in Video Flash (for DZ-GX20A only)

When recording photos in a dark place, or if the subject is lit from rear, the DZ-GX20A makes use of the built-in Video Flash for automatic brightening: The Video Flash can also be set to On where the light is always being emitted, or Off when you wish to record without using the flash even in a dark place.

Setting	On-screen display	Manner of emitting light
Auto	 when the PHOTO button is pressed	Automatically emits light in dark place or in a spot lit from rear.
On		Always emits light regardless of brightness.
Off		No light emission.

1 Press the MENU button, and choose Flash from the Camera Functions Setup menu.

2 Choose the option for Flash and decide it.

3 Press the MENU button to end the setting.

* Displayed when using DZ-GX20A to record photo (not displayed when the optional Video Flash is connected)

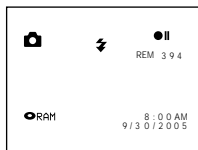
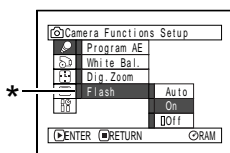



● Optional Video Flash (for DZ-GX20A or DZ-MV780A only)

See “Introduction to Optional Accessories” on page 151.

You can use the optional DZ-FLH3 Video Flash* (p. 151): Refer to the instruction manual of Video Flash for use.

* Unavailable for DZ-MV730A.

Note:

- The built-in Video Flash setting will not change even when the DVD video camera/recorder is turned off. Unless recording is to be made with the fixed Flash setting, it is recommended to return it to “Auto” after recording with the “On” or “Off” setting, before turning the DVD video camera/recorder off.
- When recording dark subjects, the shutter speed will be slower, so don’t let the camera shake.
- However, dark subjects may not be in clear focus even if the Video Flash is used. It is recommended that you light a subject when recording in a dark place.
- The built-in Video Flash cannot be used when a conversion lens is attached: Specify “Flash: Off”.
- The Video Flash automatically adjusts the amount of light emitted, but the light amount adjustment may be insufficient when a subject is too far away or too near.
- The distance for the built-in Video Flash to adjust the appropriate amount of light will vary depending on the subject, but it is approximately 3.2 – 8.2 feet (1 – 2.5 m).
- When recording a close-up photo, specify Flash: Off. Using the flash too near subject could cause a whitish image.
- “” will blink during charging of the battery for Video Flash.
- While “” is flashing, the video flash will not emit light, though the DVD camera/recorder is recording.
- Do not use the Video Flash when approaching the human eye. Emitting light from Video Flash near human eye could damage the subject’s eyesight. Especially when recording a baby or small child, move the DVD video camera/recorder at least 3.2 feet (1 m) away.
- Do not use the Video Flash while pointing it at a driver in vehicle: Doing so could dazzle the driver, causing an accident.
- Do not use the Video Flash in a place where there is flammable or explosive gas: Doing so could cause fire or explosion.
- When the DZ-FLH3 is attached to DZ-GX20A, the built-in video flash in DZ-GX20A will not operate.

Viewing on TV Screen

CONNECTING TO A TV

Use the provided AV/S input/output cable to connect the DVD video camera/recorder to a TV as follows:

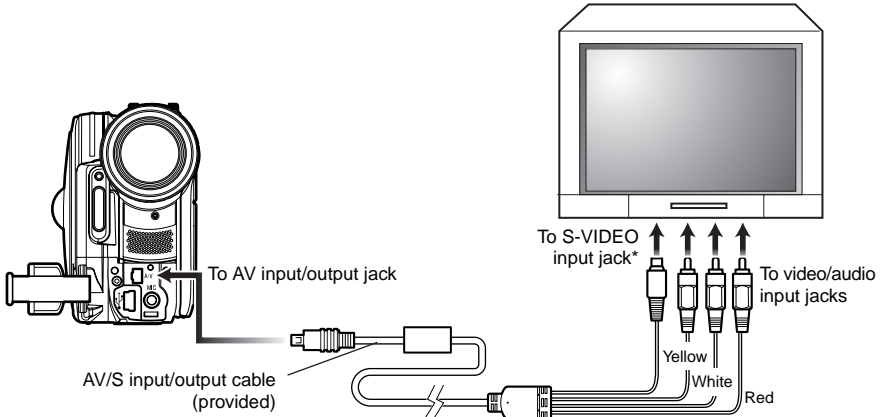

* If your TV has an S-VIDEO input jack, you can connect the S-VIDEO plug to it.

Note:

- Using S-VIDEO will deliver clearer playback status.
- Before connecting, make sure that the volume on TV is turned down: Forgetting this may cause howling (see "Terminology", p. 155) from the TV speakers.
- Insert the AV/S input/output cable plugs into jacks straight: Obliquely inserting them could damage the jacks.

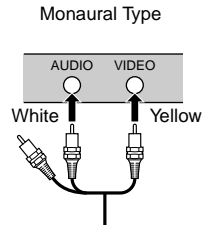
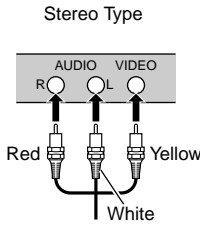
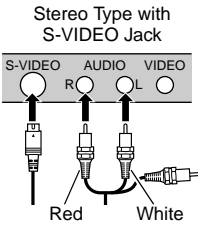

VIEWING ON TV SCREEN

- 1 Turn the TV on and set the input selector to “VCR” whichever applicable Video input.

Refer to the TV instruction manual for how to switch the TV input.

- 2 Turn the DVD video camera/recorder on.

The image that the DVD video camera/recorder is seeing will appear on the TV screen.

You can also monitor the image on the LCD screen or viewfinder of the DVD video camera/recorder.

- 3 Perform playback, recording or editing.

You can perform playback, editing or editing on Disc Navigation while checking on TV screen.

Note:

- Adjust the volume of sound on TV.
- The infrared remote control is useful when operating the DVD video camera/recorder while viewing an image on TV screen. However, if you use a Hitachi VCR, the remote control may inadvertently operate the VCR if it is near the DVD video camera/recorder. To prevent this, set the remote control code of the VCR to a position other than “VCR2”.
- Information that the DVD video camera/recorder is recording will appear on the TV screen: You can also display only part of information or switch off the display. Refer to “SETTING ON-SCREEN DISPLAY OUTPUT ON OR OFF (OSD OUTPUT)” on page 97, and press the DISPLAY button to switch the display status.
- When copy-guarded disc is played back, no image will appear on TV screen.
- If you use TV with wide mode (aspect ratio 16:9) and set the TV to the wide mode, the entire Disc Navigation display may not be displayed on the TV screen. If this happens, release the wide mode setting on TV (see the TV instruction manual for releasing the wide mode).

Playback on DVD Recorder/Player

PLAYING BACK DVD-RAM DISC

You can use a DVD recorder (see “Terminology”, p. 155) or DVD player that conforms to DVD-RAM to play back 8 cm DVD-RAM discs recorded on this DVD video camera/recorder.

- 1 Insert the disc into the DVD recorder/player and play it back.

See the instruction manual for DVD recorder/player.

Note:

- When playing back disc on another device, the Disc Navigation display will be different from the one on this DVD video camera/recorder.

PLAYING BACK DVD-R DISC

- 1 Finalize a recorded DVD-R disc.

You need to finalize (see “Terminology”, p. 155) a disc to play it back on DVD player: See page 135.

No further data can be recorded on finalized disc.

Note:

Use this DVD video camera/recorder to finalize the DVD-R disc recorded on the DVD video camera/recorder.

- 2 Insert the disc into the DVD player and play it back.

See the instruction manual for DVD player.

Note:

- Do not insert a DVD-R disc that has not been finalized into any DVD recorder: The disc may be unusable (except for devices that allow playback of a DVD-R disc not finalized on this DVD video camera/recorder).
- DVD-R discs recorded on this DVD video camera/recorder or other 8 cm DVD-R discs can be played back on other DVD players or other devices conforming to 8 cm DVD-R, but playback on all DVD players is not guaranteed.
- Playback may not be possible on some DVD players, or it may depend on the recorded status of DVD-R discs: In such cases, play back the DVD-R disc on this DVD video camera/recorder. Also, playback on DVD players may stop momentarily between scenes.

Recording (Dubbing) Images

Before You Begin

- Before connecting this DVD video camera/recorder to another device, be sure to turn both devices off.
- Insert a recordable DVD-RAM disc or card* into this DVD video camera/recorder (see p. 24, 27).
- * Only photos can be recorded: No video can be recorded.

RECORDING (DUBBING) IMAGES FROM OTHER VIDEO DEVICE

You can record (dub) images from other video devices to disc or card in this DVD video camera/recorder.

Use the AV/S input/output cable (provided) to connect the DVD video camera/recorder to the other video device as follows:

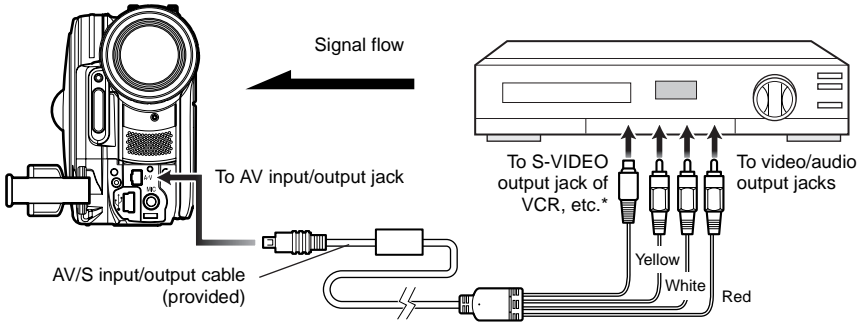

* If you are using DZ-GX20A or DZ-MV780A, and the connected AV device has an S-VIDEO output jack, you can connect the S-VIDEO jack of AV/S input/output cable.

1 Set the input source on the DVD video camera/recorder to "LINE (L IN)".

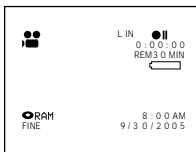

Switch the input referring to "Input Source" on page 94.

Choose "S LINE" to input S-VIDEO signal (only for DZ-GX20A or DZ-MV780A).

2 Turn on the connected device, and start playback.

The picture will appear on the LCD screen or viewfinder of this DVD video camera/recorder.

3 Press the REC button.

Recording will start on this DVD video camera/recorder.

The operation of this line-input recording is the same as for recording movie. Press the PHOTO button when recording a photo.

Note:

- If you operate the DVD video camera/recorder connected to another device, always power the camera/recorder from AC outlet using the AC adapter/charger.
- If you use a Hitachi VCR, it will be operated by the remote control provided with the DVD video camera/recorder. When recording an image from a Hitachi VCR, change the remote control code of the VCR to other than "VCR2".
- With DZ-GX20A or DZ-MV780A, using S-VIDEO will enable you to record clearer images.
- The DZ-MV730A cannot record S-VIDEO input.
- Reduce the volume of external input sound heard from the built-in speaker: The loud volume may cause noise to enter the recorded image.
- The recorded contents can be played back in the same manner as when playing back camera images recorded on this DVD video camera/recorder.
- The "Input Source" setting will return to "CAMERA" whenever DVD video camera/recorder is turned off.
- Recording of most images is prohibited by the copy-guard signal to protect the copyright, except for images recorded on camcorders for personal enjoyment. "COPY PROTECTED" appears in these images: They cannot be recorded on this DVD video camera/recorder.

Typical copyright protected images include those of DVD video, LD, recorded video tapes, some parts of digital satellite broadcasts, etc.

- If a video signal that cannot be read by this DVD video camera/recorder is present – even in images recorded on camcorder for personal enjoyment without copy-guard signal – the input image may not be recorded normally.
- If the input signal is interrupted by switching the channel on TV or switching the signal using video selector (see "Terminology", p. 155), normal recording cannot be performed.

RECORDING (DUBBING) IMAGES FROM OTHER VIDEO CAMERAS

You can record (dub) images from other video cameras on a DVD-RAM disc or card* in DVD video camera/recorder. Use the AV/S input/output cable (provided) to connect the DVD video camera/recorder to the other video camera.

* Only photos can be recorded: No video can be recorded.

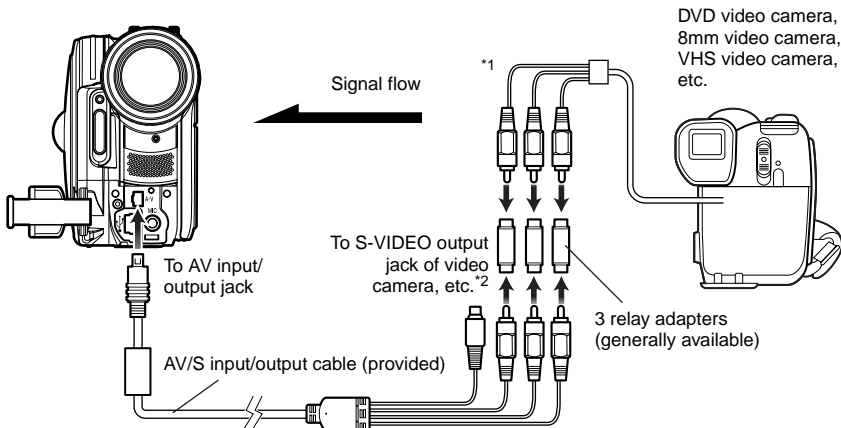

*1: The AV/S input/output cable provided with this DVD video camera/recorder can be directly connected to some video cameras.

*2: If the video camera to be connected has an S-VIDEO output jack, you can connect it to the DVD video camera/recorder (only for DZ-GX20A or DZ-MV780A).

1 Set the input source on the DVD video camera/recorder to “LINE (L IN)”.

Switch the input referring to “Input Source” on page 94.

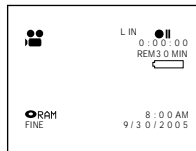

Choose “S LINE” to input S-VIDEO signal (only for DZ-GX20A or DZ-MV780A).

2 Turn on the connected device, and start playback.

The picture will appear on the LCD screen or viewfinder of this DVD video camera/recorder.

3 Press the REC button.

Recording will start on this DVD video camera/recorder.

The operation of this line-input recording is the same as for recording movie.

Note:

- With DZ-GX20A or DZ-MV780A, using S-VIDEO will enable you to record clearer images.
- Reduce the volume of external input sound heard from the built-in speaker: The loud volume may cause noise to enter the recorded image.
- Still images can also be recorded on DVD-RAM disc or card. See “SWITCHING EXTERNAL INPUT RECORDING METHOD (PHOTO INPUT)” on page 95 for details, and “Recording Stills” on page 51 for how to record still images.

RECORDING (DUBBING) IMAGES ON OTHER VIDEO DEVICES

You can record (dub) images played back on this DVD video camera/recorder, on other video devices.

Use the AV/S input/output cable (provided) to connect the DVD video camera/recorder to another video device as shown in the following figure:

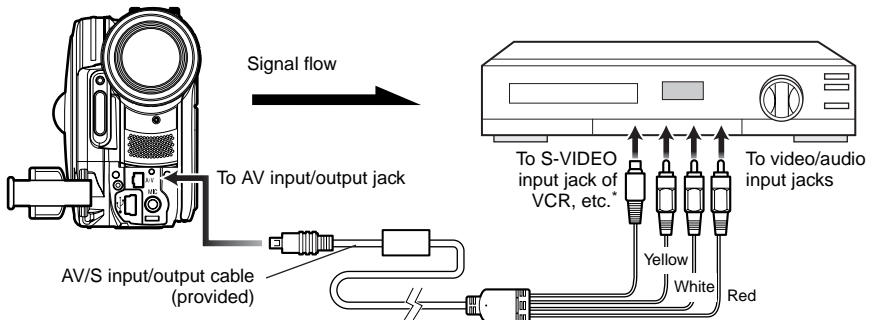

* If the video device to be connected has an S-VIDEO input jack, you can connect it to the DVD video camera/recorder.

- 1 Press the DISC NAVIGATION button.
- 2 Select a scene to be played back.
- 3 Set the channel of the connected video device to an external input.
- 4 Press the playback (▶/||) button on this DVD video camera/recorder and the record button on connected device: The DVD video camera/recorder will start playback and the recorded device will record (dub) it.

Note:

- Using an S-VIDEO jack will deliver clearer images.
- Audio is heard from the speaker: If the volume is too high, noise may enter the dubbed image.
- It is recommended that you use Disc Navigation to create a play list including the scenes to be dubbed among the scenes recorded on this DVD video camera/recorder (p. 124).
- Be sure to use the AC adapter/charger to power the DVD video camera/recorder from AC outlet, to prevent battery power from shutting off during recording on another video device.
- If you are using a Hitachi VCR, using the remote control provided with this DVD video camera/recorder may operate the VCR. To record (dub) images from the DVD video camera/recorder to Hitachi VCR, change the remote control code of VCR to a position other than "VCR2".

Advanced Techniques

This section explains about various settings to further extend the usefulness of this DVD video camera/recorder.

Checking Flow of Normal Menu

The following two on-screen menu modes are available with this DVD video camera/recorder:

- Quick Menu: To display only the fundamental menu items for first timers (p. 63)
- Normal Menu: To display all menu items for experts

Camera Functions

Press the MENU button while the camera image is being displayed on the LCD monitor: The Normal Menu will appear.

Use the **◀◀/▶▶/◀▶/▶▶** buttons to select a menu item, and then press the **▶/||** button to choose the option.

See page 64 for the setting method.

The screens used here to explain are displayed when DVD-RAM disc is used. Some items will not appear when a DVD-R disc or card is used, or when no disc is inserted.

No menu appears during recording.

<Menu screen for setting>

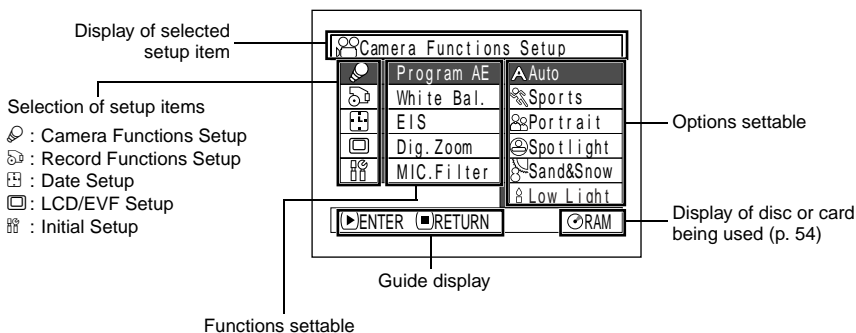

● Flow of Normal Menu

Refer to page indicated for details of each function.

Camera Functions Setup *6

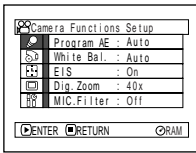

Program AE (p. 86)

White balance (p. 88)

EIS*1 (p. 90)

Digital zoom (p. 56)

Microphone filter*2 (p. 90)

Flash*3 (p. 76)

*1: Not displayed when DZ-GX20A or DZ-MV780A is in "☐" or "📷" status.

*2: Displayed only in "📷" status.

*3: Displayed when DZ-GX20A is recording a photo (not displayed when the optional Video Flash is connected).

Record Functions Setup

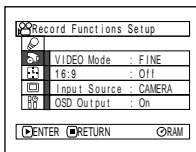

Movie quality*4 (p. 91)

16:9*5 (p. 92)

Input selection (p. 94)

External still input*6 *9 (p. 95)

Self-timer*7 (p. 96)

On-screen information display output*8*9 (p. 97)

*4: Not displayed with DVD-RAM disc in "☐" status. The quality mode is displayed in "📷" status. (p. 94)

*5: Not displayed in "☐" or "📷" status, or with external input.

*6: Displayed with DVD-RAM disc in "☐" status, or "📷", and input selection is set to external signal or S external signal.

*7: Displayed with DVD-RAM disc in "☐" status, or "📷" status.

*8: Displayed only when input selection is set to camera.

*9: Not displayed in Quick Menu.

Date Setup

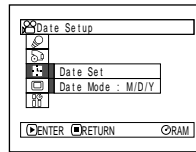

Date setting (p. 37)

Display format*9 (p. 38)

LCD/EVF Setup *9

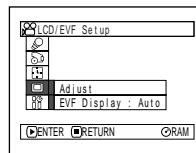

Adjust (p. 98)

EVF Display (p. 99)

Initial Setup

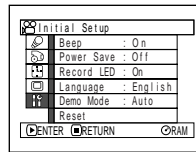

Beep*9 (p. 100)

Power save*9 (p. 100)

Recording LED*9 (p. 101)

Language selection (p. 101)

Demo mode (p. 154)

Reset (p. 102)

Setting Up Camera Functions

Before You Begin

- See page 64 for how to set.
- No menu screen appears with external input.

SELECTING SHOOTING MODE TO MATCH THE SUBJECT (SWITCHING PROGRAM AE MODE)

This DVD video camera/recorder automatically detects the status of subject and surrounding situation and records the optimum image: If you choose the shooting mode to match the recording conditions, clearer images will be recorded.

1 Press the MENU button, use the **◀◀/▶▶/▶▶/▶▶** buttons to choose "Program AE" on the "Camera Functions Setup" screen, and then press the **▶/||** button.

The options will appear on the right of "Program AE".

2 Use the **◀◀/▶▶/▶▶/▶▶** buttons to choose the desired option, and then press the **▶/||** button: The selected option will be set.

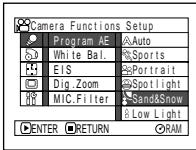

Selected AE mode

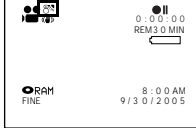

3 Press the MENU button to end the setting.

The menu screen will disappear.

Note:

- You can check the selected AE mode by the on-screen information display. However, nothing will appear in the Auto mode.
- The shooting mode set as above will be stored in memory even if the DVD video camera/recorder is turned off.
- When recording in a dark area, an after-image will appear when filming a moving subject or if camera shake occurs (it is therefore recommended that you use a tripod in such cases).
- If the Sports mode is used under a fluorescent light, the image may flicker: In this case, use the Auto mode for recording.

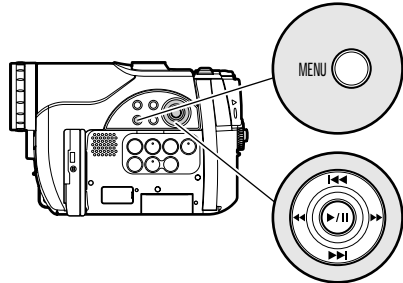

Use **◀◀/▶▶/▶▶/▶▶** to select, and then press **▶/||** to designate.

Auto : The camera/recorder automatically judges the subject and surrounding environment for optimum recording.

Sports : Reduces blurring when recording rapidly moving subjects such as in golf or tennis.

Portrait : Makes a subject, such as a person or a creature, stand out from a blurred background.

Spotlight : Prevents overexposure of subject portrait face, etc. when strong light strikes the subject, as in a wedding or on stage.

Sand & Snow : Prevents underexposure of subject portrait face, etc. in a place where reflection of light is intense, such as at the seaside in midsummer or on a ski slope.

Low Light : Allows user to record in a dark place even with decreased lighting.

Turn the LCD monitor 180° during recording: The LCD monitor light can then be used for recording.

RECORDING DARK SUBJECTS USING LCD MONITOR LIGHT

When Program AE is set to Low Light, you can use the light from LCD monitor to record a subject.

1 Press the MENU button, and choose “Program AE” from the “Camera Functions Setup” menu.

2 Choose “Low Light”, and designate it.

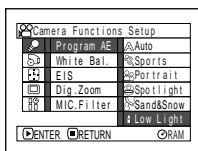

3 Press the MENU button to end the setting.

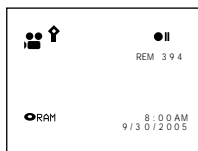

4 Open the LCD monitor, turn it 180° so that it faces the same direction as the lens: The LCD monitor will light white.

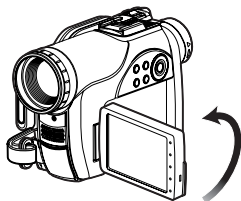

Note:

- Use the viewfinder to check the image to be recorded.
- The LCD monitor light allows you to record a subject up to 3.2 feet (1 m) even in a dark place.
- An after-image will appear when filming a moving subject or if camera shake occurs (it is recommended that you use a tripod).
- If a subject cannot be focused properly, manually adjust the focus (see page 72).

ADJUSTING COLOR (WHITE BALANCE)

This DVD video camera/recorder automatically adjusts the color of subject. Change the white balance setting depending on the recording conditions.

Mode	Setting content	On-screen display
Auto	White balance always automatically adjusted	None
Set	You can manually adjust white balance to match the light source or situation (p. 89)	
Outdoor	To record in fine weather	
Indoor 1	To record under incandescent light, halogen light or bulb-color type fluorescent light	
Indoor 2	To record under fluorescent light	

1 Press the MENU button, choose “White Bal.” on the “Camera Functions Setup” menu screen, and then press the **▶/||** button.

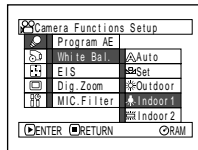

2 Choose the desired option, and then press the **▶/||** button.

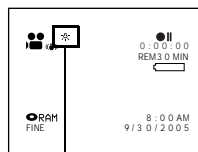

White balance mode

3 Press the MENU button to end the setting.

Note:

- The white balance mode can be confirmed using the on-screen information.
- The white balance setting will be stored in memory even when the DVD video camera/recorder is turned off.
- Do not block the infrared sensor (see “Terminology”, p. 155) with hand, etc.

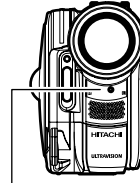

Infrared sensor block

- If a tele or wide-conversion lens is used, the auto white balance may not operate depending on the recording conditions. If this happens, set to the mode to match the recording conditions, or manually set the white balance.
- Be sure to remove the lens cap before turning the DVD video camera/recorder on: If the DVD video camera/recorder is turned on with the lens capped, the white balance will not work normally.

● Setting white balance manually

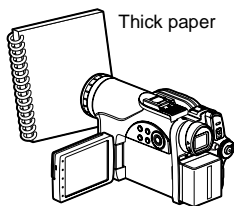

1 Point the DVD video camera/recorder at a white object so that it fills the screen. Use an object that is not transparent.



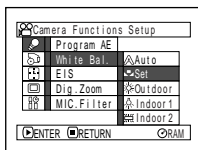

If focus is not correct when the white object fills the screen, manually focus the object, referring to “Manually Focusing Subject” (see page 72).

2 Press the MENU button, choose “White Bal.”, “Set”, and then press the ►/|| button.



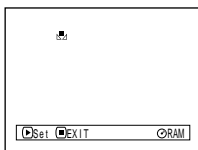

3 Hold ►/|| pressed until the “” indicator changes from blinking to a steady light. When the “” indicator lights, the white balance setting will be complete.

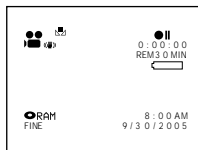

4 Press the  button to end the setting.



Note:

- The white balance set using the “Set” option will be stored in memory until it is re-set.
- Do not use a colored object when setting the white balance: The appropriate tint cannot be set.
- If “Input Source: LINE, S-LINE” has been specified, you cannot use the “Set” mode of white balance (p. 94).
- The setting on white balance “Set” may not be possible in a dark place. Also, the white balance cannot be set when the zoom bar is in the digital zoom range (p. 56). In such status, the “” indicator will remain blinking. Set the white balance in a bright place with “Dig. Zoom Off” specified.
- If the recording conditions have changed, re-set the white balance for appropriate colors.
- The setting will be stored in memory even when the DVD video camera/recorder is turned off: The “” indicator will blink when the DVD video camera/recorder is turned on next time. Re-set the white balance as needed.

USING THE ELECTRONIC IMAGE STABILIZER (EIS)

When you use zoom (see page 56) to record a magnified subject image, it will correct fuzziness in the recorded image.

- 1 Press the MENU button, choose “EIS” on the “Camera Functions Setup” menu screen, and then press the ►/|| button.

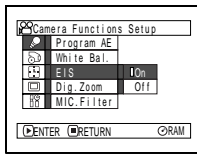

- 2 Choose the “On” or “Off”, and then press the ►/|| button.

- 3 Press the MENU button to end the setting.

● Checking EIS On or Off

You can check EIS On or Off by the on-screen information display.

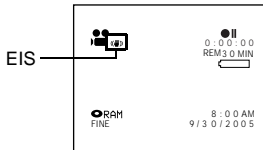

After recording with EIS set to “Off”, it is recommended that you return the setting to “On” and then turn the DVD video camera/recorder off, unless you normally record with “Off” setting.

Note:

- The EIS setting will be stored in memory even when the DVD video camera/recorder is turned off.
- It is recommended that you specify “EIS Off” when using the DVD video camera/recorder on a desk or tripod.
- When “EIS On” is specified, there will be a slight difference between the actual movement and the movement on screen.
- Gross camera shake may not be entirely corrected even if “EIS On” is specified: Firmly hold the DVD video camera/recorder with both hands.
- EIS may not operate correctly when the tele or wide-conversion lens is used.
- EIS cannot be used when recording photos on DZ-GX20A or DZ-MV780A.

RECORDING SUBJECT USING LARGE MAGNIFICATION (DIGITAL ZOOM)

See page 56 for setting on digital zoom.

REDUCING WIND NOISE DURING RECORDING (MIC.FILTER)

When recording sound from the microphone built into this DVD video camera/recorder, you can reduce wind noise in recording.

If “MIC.Filter: ON” is specified, the low-frequency components in the sound picked up by microphone will be cut off during recording: This makes it easier to hear the target voice or sound during playback.

- 1 Press the MENU button, choose “MIC.Filter” on the “Camera Functions Setup” menu screen, and then press the ►/|| button.

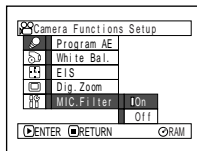

- 3 Press the MENU button to end the setting.

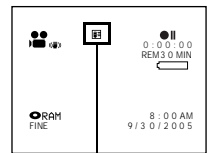

Microphone filter icon

Note:

- You can also use the on-screen display to confirm that the MIC.Filter has been set.
- The MIC.Filter setting will be stored in memory even when the DVD video camera/recorder is turned off.
- The MIC.Filter function will work only during movie recording.
- The microphone filter function works only with the built-in microphone: It will not function when using an external microphone (p. 75).

Setting Up Record Functions

RAM R

SWITCHING MOVIE QUALITY (VIDEO MODE)

Choose the movie quality from “XTRA”, “FINE”, “STD”.

It is recommended that you record critical subjects in the “XTRA” or “FINE” mode. (p. 28)

1 Press the MENU button, use “Operating Menu” (p. 64) to choose “VIDEO Mode” on the “Record Functions Setup” menu screen, and then press the ►/|| button.

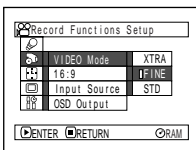

2 Choose the desired quality mode, and then press the ►/|| button.

3 Press the MENU button to end the setting.

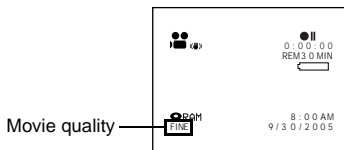

Note:

- The movie quality setting will be stored in memory even when the DVD video camera/recorder is turned off.
- The “VIDEO Mode” setting will not change even if the disc is replaced.
- When using DVD-R disc, you cannot switch the setting on movie quality or wide-screen mode while recording on the disc: The DVD video camera/recorder will be automatically set to the movie quality or wide-screen mode first used with the disc for recording.
- The movie quality setting is effective only during movie recording: The setting will not be displayed during recording of stills.

Block-like noise may appear in recorded image, or the outline of subject image is distorted under the recording conditions listed below: Pan the DVD video camera/recorder as slowly as possible. (Block noise is likely to appear in the “STD” mode):

- If there is a complicated pattern in background (as in following figure on left)
- If the DVD video camera/recorder is moved excessively or quickly
- If subject is moving rapidly even when the DVD video camera/recorder is not moving

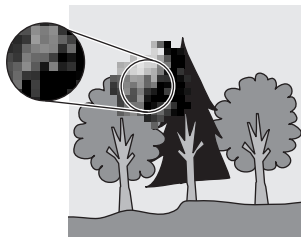

(Image when block-like noise occurs)



(Image without block-like noise)

SETTING TO WIDE TV SCREEN MODE (16:9 MODE)

When viewing recorded images later on a wide-screen TV (aspect ratio 16:9), specify wide-screen (16:9) mode "On": You can also record images with the aspect ratio changed (the aspect ratio with "Off" is 4:3).

"16:9 On" specified
(aspect ratio 16:9)

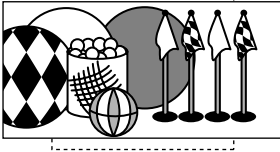

"16:9 Off" specified
(aspect ratio 4:3)

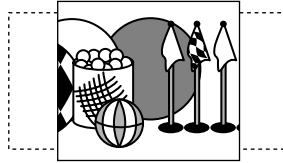

- 1 Press the MENU button, choose "16:9" on the "Record Setup Functions" menu screen, and then press the ►/|| button.
- 2 Choose "On", and then press the ►/|| button.
- 3 Press the MENU button to end the setting.

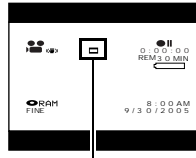
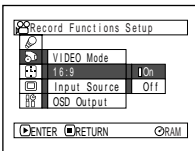

16:9 mode icon

When viewing playback on an ordinary TV screen later, specify "16:9 Off": Recording with "16:9 On" specified will be played back on an ordinary TV with longer vertical direction of image.

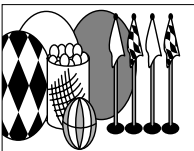

An image recorded with "16:9 On" specified will appear as follows:

Display on LCD monitor screen

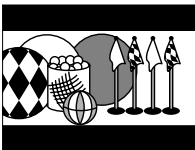

Display in viewfinder

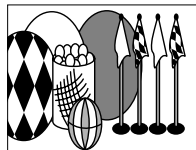

Note:

- The 16:9 setting will be kept even after the DVD video camera/recorder is turned off.
- The 16:9 mode cannot be used with photo recording, external input, S-VIDEO external input (for DZ-GX20A or DZ-MV780A only), or "STD" recording using DVD-R disc.
- Once the DVD-R disc has been recorded in the wide-screen mode, you will not be able to switch to recording of external input or S-VIDEO external input (DZ-GX20A or DZ-MV780A only) using the same disc.
- Once the DVD-R disc has been recorded in the normal (4:3) mode, you will not be able to switch it to the wide-screen mode using the same disc.
- Once a DVD-R disc has been recorded in the 16:9 mode, you will not be able to switch it to the normal (4:3) mode using the same disc.
- Images recorded with "16:9 On" (aspect ratio 16:9) specified will be played back with the setting used during recording regardless of the 16:9 setting then being used.
- The characters of dates and titles will be longer in the vertical direction on a wide-screen TV and on the LCD monitor of this DVD video camera/recorder.
- When "16:9 On" is specified, black bands will appear across the top and bottom of LCD monitor screen (except on menu or Disc Navigation screen, or playback image recorded with "16:9 Off" is specified).
- The 16:9 setting is not compatible with ID-1/ID-2*.
- To view images recorded at 16:9 setting, switch the aspect ratio of your TV: See TV instruction manual for this switching.
- When using a video selector (see "Terminology", p. 155), the TV may not automatically be switched to 16:9 mode.

* This system records the aspect ratio (16:9, 4:3) information in void space between video signals.

SWITCHING QUALITY OF STILL IMAGE (QUALITY)

You can switch the still recording quality only when using card.

It is recommended that you use “FINE” when recording vital images. (p. 30 “SIZE AND QUALITY OF PHOTOS”)

1 Press the MENU button, use “Operating Menu” (p. 64) to choose “Quality” on the “Record Functions Setup” menu screen, and then press the ►/|| button.

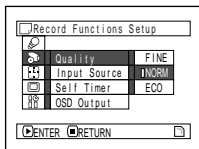

3 Press the MENU button to end the setting.

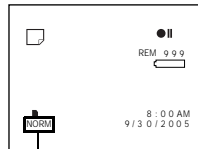

Still recording quality

2 Choose the option you want, and then press the ►/|| button.

Note:
The still quality setting will be stored in memory even when the DVD video camera/recorder is turned off.

RECEIVING IMAGE FROM ANOTHER DEVICE (INPUT SOURCE)

If you wish to input an image from another device to this DVD video camera/recorder, you must first switch the setting on the DVD video camera/recorder. Refer to the explanation starting from page 80 on how to connect the DVD video camera/recorder to other devices or record images input from them.

Setting	Content	On-screen display
CAMERA	Usually select this option.	No display
LINE	To input image from another device	L IN
S LINE*	To input S-VIDEO signal from another device	S IN

* Displayed on DZ-GX20A or DZ-MV780A only.

1 Press the MENU button, use “Operating Menu” (p. 64) to choose “Input Source” on the “Record Functions Setup” menu screen, and then press the ►/|| button.

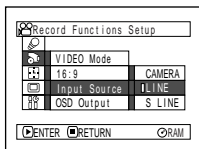

3 Press the MENU button to end the setting.

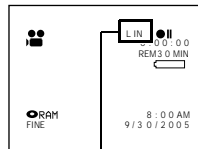





External input icon

Note:
The “Input Source” setting will return to “CAMERA” whenever the DVD video camera/recorder is turned off.

2 Choose “LINE”, and then press the ►/|| button.

SWITCHING EXTERNAL INPUT RECORDING METHOD (PHOTO INPUT)

When “Input Source: LINE or S LINE” is specified, you can record stills of externally input images on either a DVD-RAM disc or a card. The DVD video camera/recorder can record an external image with little movement by specifying “Frame”, but “Field” is recommended for recording image with movement.

Recording format	Details of setting	On-screen display	
		DVD-RAM	card
Frame	Does not suit recording of frequently moving video subjects, despite high image quality. Frame suits recording of less moving video.		
Field	Suitable for recording of frequently moving video subjects.		

1 Press the MENU button, use “Operating Menu” (p. 64) to choose “PHOTO Input” on the “Record Functions Setup” menu screen, and then press the ►/|| button.

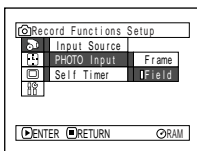

Note:

- The PHOTO Input setting can be confirmed using the on-screen information.
- The PHOTO Input setting will be stored in memory even when the DVD video camera/recorder is turned off.
- Refer to “Recording (Dubbing) Images”, p. 80 to see how to connect the DVD video camera/recorder to another device.

2 Select the desired option and then press the ►/|| button.

3 Press the MENU button to end the setting.

Still external input icon (Field)

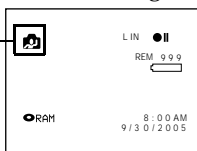

SELF-TIMER

You can record photos using the self-timer function, as with ordinary cameras.

The self-timer function is valid only when recording photos (stills).

1 Press the MENU button, use “Operating Menu” (p. 64) to choose “Self Timer” on the “Record Functions Setup” menu screen, and then press the ►/|| button.

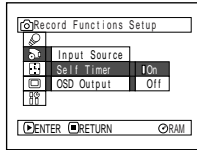

2 Select “On”, and then press the ►/|| button.

The self-timer will be set.

3 Press the MENU button to end the setting.

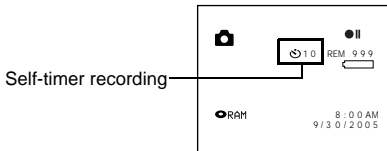

4 Press the PHOTO button.

The recording indicator at the front of DVD video camera/recorder will blink. The self-timer indicator will start to count down, and recording will commence approximately 10 seconds later.

Note:

- You can also check that self-timer has been set by reviewing the on-screen information.
- To release the self-timer mode, choose “Off” on the menu screen or turn DVD video camera/recorder off.
- To suspend self-timer, press the PHOTO button again before recording starts, or press the ■ button.

SETTING ON-SCREEN DISPLAY OUTPUT ON OR OFF (OSD OUTPUT)

If you connect this DVD video camera/recorder to a TV to view images on TV screen, you can switch off the on-screen information (displayed in the viewfinder or on the LCD screen) from the TV screen.

1 Press the MENU button, use “Operating Menu” (p. 64) to choose “OSD Output” on the “Record Functions Setup” menu screen, and then press the ►/|| button.

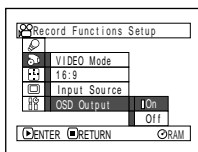

2 Choose “On” or “Off”, and press the ►/|| button.

3 Press the MENU button to end the setting.

Note:

- The “OSD Output” setting will be stored in memory even when the DVD video camera/recorder is turned off.
- Even if “Off” is chosen, the on-screen information will appear during playback. See page 62 for playback on-screen information display.
- Even after the on-screen information is removed from the TV screen, it will still appear in the viewfinder or on the LCD screen.
- The on-screen display output functions only when the input selection is set to camera: It cannot be set during external input.

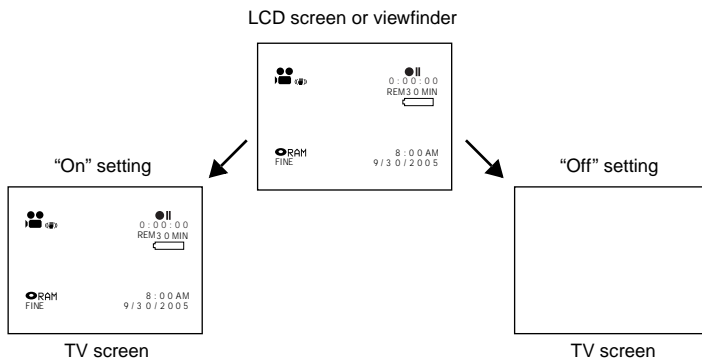

LCD/EVF Setup

SETTING BRIGHTNESS OF LCD SCREEN (LCD BRIGHTNESS)

- 1** Press the MENU button, use “Operating Menu” (p. 64) to choose “Adjust” on the “LCD/EVF Setup” menu screen, and then choose “LCD Brightness”.

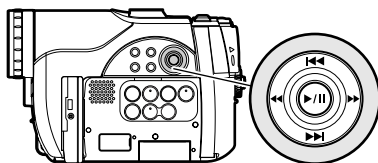
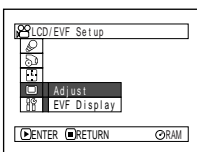

Use **◀▶▶▶** / **▶▶▶▶** to select, and then press **▶/II** to designate.

The brightness adjustment bar will appear on the screen.

- 2** Use the **◀▶▶▶** buttons for adjustment.

Press **◀▶▶▶** :
The screen becomes dimmer.

Press **▶▶▶▶** :
The screen becomes brighter.

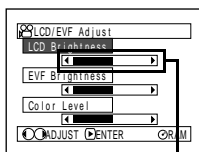

Brightness adjustment bar

- 3** Press the MENU button to end the setting.

Note:
The brightness setting will be stored in memory even after the DVD video camera/recorder is turned off.

SETTING BRIGHTNESS OF VIEWFINDER (EVF BRIGHTNESS)

- 1** Press the MENU button, use “Operating Menu” (p. 64) to choose “Adjust” on the “LCD/EVF Setup” menu screen, and then choose “EVF Brightness”.

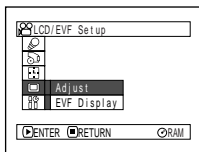

- 3** Press the MENU button to end the adjustment.

Note:
The brightness setting is stored in memory even after the DVD video camera/recorder is turned off.

- 2** Use the **◀▶▶▶** buttons for adjustment.

Press **◀▶▶▶** :
The screen becomes dimmer.

Press **▶▶▶▶** :
The screen becomes brighter.

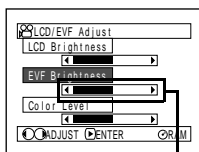

Brightness adjustment bar

SETTING COLOR DENSITY (COLOR LEVEL)

You can adjust the color density of the LCD monitor screen and viewfinder.

- 1 Press the MENU button, use “Operating Menu” (p. 64) to choose “Adjust” on the “LCD/EVF Setup” menu screen, and then choose “Color Level”.

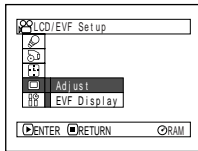

- 3 Press the MENU button.

Note:

- The color setting will be stored in memory even after the DVD video camera/recorder is turned off.
- Even if the brightness or density of LCD monitor screen or viewfinder is changed, the brightness or density of the recorded image itself will not change.

The color density adjustment bar will appear on the screen.

- 2 Use the ◀▶ buttons for adjustment.

Press ◀▶ :

For lighter color.

Press ▶▶ :

For denser color.

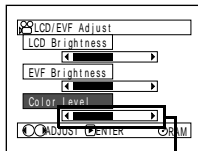

Color density adjustment bar

ALWAYS DISPLAYING IMAGE IN VIEWFINDER

- 1 Press the MENU button, use “Operating Menu” (p. 64) to choose “EVF Display” on the “LCD/EVF Setup” menu screen.

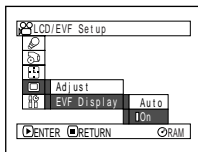

Note:

The setting on EVF Display will be stored in memory even after the DVD video camera/recorder is turned off.

- 2 Choose “On” and decide it.
- 3 Press the MENU button to end the setting: Images will always appear in the viewfinder regardless of whether the LCD monitor is open/closed.

Initial Settings

SWITCHING OPERATING SOUND ON OR OFF (BEEP)

Setting	Content
On	Beep is heard when the power switch is changed over, the REC button is pressed, etc.
Off	No beep is heard.

- 1 Press the MENU button, use “Operating Menu” (p. 64) to choose “Beep” on the “Initial Setup” menu screen, and then press the ►/|| button.

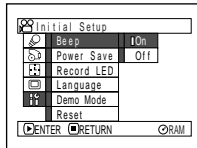

- 2 Select “On” or “Off”, and then press the ►/|| button.

- 3 Press the MENU button to end the setting.

Note:

The “Beep” setting will be stored in memory even when the DVD video camera/recorder is turned off.

TURNING DVD VIDEO CAMERA/RECORDER OFF AUTOMATICALLY (POWER SAVE)

Setting	Content
On	To engage power save. If the DVD video camera/recorder is left in the recording pause status without being operated for 5 minutes, it will automatically turn off to prevent the battery from discharging needlessly.
Off	To cancel power save.

- 1 Press the MENU button, use “Operating Menu” (p. 64) to choose “Power Save” on the “Initial Setup” menu screen, and then press the ►/|| button.

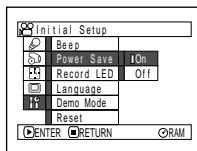

- 2 Select “On” or “Off”, and then press the ►/|| button.

- 3 Press the MENU button to end the setting.

Note:

- To turn the DVD video camera/recorder on again from automatic off activated by the power save function, set the power switch to “OFF”, and then set it to “”, “” or “”.
- The Power Save setting will not appear in the on-screen information display.
- The Power Save setting will be stored in memory even when the DVD video camera/recorder is turned off.

TURNING RECORD LED ON OR OFF (RECORD LED)

You can switch off the recording indicator on the front of DVD video camera/recorder even during recording.

Setting	Content
On	The recording indicator will light red to show that the DVD video camera/recorder is recording.
Off	The recording indicator will not light even during recording.



Recording indicator

- 1 Press the MENU button, use “Operating Menu” (p. 64) to choose “Record LED” on the “Initial Setup” menu screen, and then press the ►/|| button.

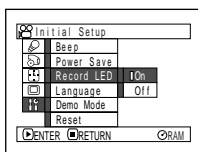

- 2 Select “On” or “Off”, and then press the ►/|| button.

- 3 Press the MENU button to end the setting.

Note:

- The Record LED setting will not appear in the on-screen information display.
- The Record LED setting will be stored in memory even when the DVD video camera/recorder is turned off.
- Specify “Record LED: Off” when recording a subject behind a glass or water tank that reflects light: The reflected light of the recording indicator will not be recorded.
- Even if “Record LED Off” is specified, the recording indicator will light while the self-timer is counting down.

CHANGING DISPLAY LANGUAGE (LANGUAGE)

You can change the language used to display the menu and information. The following shows that English is changed to French.

- 1 Press the MENU button, use “Operating Menu” (p. 64) to choose “Language” on the “Initial Setup” menu screen, and then press the ►/|| button.

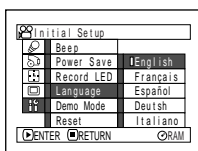

- 3 Press the MENU button to end the setting.

Note:

The language setting will be stored in memory even when the DVD video camera/recorder is turned off.

- 2 Select “Français”, and then press the ►/|| button.

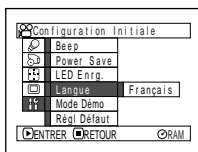

RESETTING MENU SETTINGS TO DEFAULTS (RESET)

You can restore menu settings to defaults (initial settings at the factory (p. 174)). (Note, however, that the date/time will not be reset.)

- 1 Press the MENU button, use “Operating Menu” (p. 64) to choose “Reset” on the “Initial Setup” menu screen, and then press the ►/|| button.

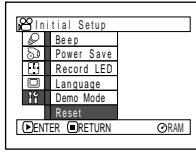

- 3 Press the MENU button to end the setting.

Note:

To cancel resetting midway, choose “NO” on the screen for verification in step 2 or press the ■ button.

The screen for verifying reset will appear.

- 2 If you are sure that you wish to reset, use the ◀◀ button to choose “YES”, and then press the ►/|| button.

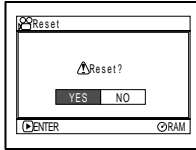

The setting items have now been reset to defaults.

Using Disc Navigation



STARTING OR TERMINATING DISC NAVIGATION

Disc Navigation is a tool for editing scenes recorded on this DVD video camera/recorder.

Here is an explanation on “scene” and “program”, so that you will be able to make most use of Disc Navigation function.

The screens in this instruction manual are basically those that will appear when DVD-RAM disc is used: Some items will not appear when DVD-R disc or card is used, but the operation is the same.

Before You Begin

- Turn the DVD video camera/recorder on (p. 44).
- When using disc: Set the power switch to “” or “”.
- When using card: Set the power switch to “”.

1 Press the DISC NAVIGATION button.

The Disc Navigation screen (shown on page 104) will appear.

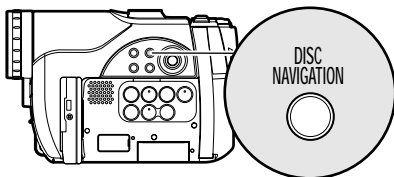

2 Press the DISC NAVIGATION button again.

Disc Navigation will be terminated and the DVD video camera/recorder will enter the recording pause status.

You can also press the  button to end Disc Navigation.

Thumbnail (see "Terminology", p. 155)

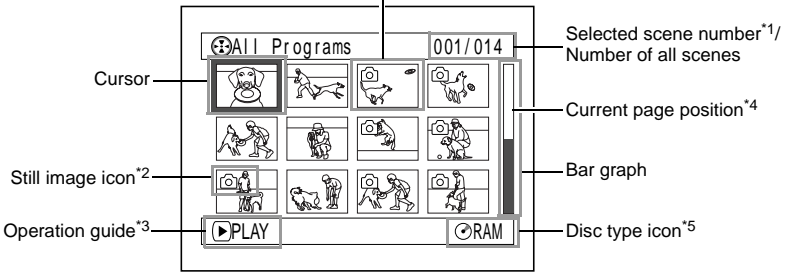

*1 Scene number refers to display number on thumbnail display screen.

*2 No still icon will appear for card.

*3 The operation guide will vary depending on the operation status of DVD video camera/recorder.

*4 Appears when 13 scenes or more have been recorded.

*5 "Ⓜ" will appear for DVD-R disc. "📷" will appear for card.

Icons to be displayed on thumbnail:

📷 Photo (p. 51)

➡ Skip (p. 115)

▲ Fade-in (p. 114)

▼ Fade-out (p. 114)

🔒 Lock (p. 118)

Note:

- The background color of screen allows you to identify whether disc or card is used on this DVD video camera/recorder.
 - Purple: When disc is used.
 - Green: When card is used.
- Pressing the DISPLAY button will display the recording date/time of the scene on which the cursor is placed in the space for operating guide. Pressing DISPLAY again will display the operating guide.
- If no disc or card is inserted, the Disc navigation screen cannot be displayed even by pressing the DISC NAVIGATION button.
- Each time Disc Navigation is started with a DVD-R disc inserted, message "Creating Thumbnail ..." will appear. After the message appears, the Disc Navigation screen will appear.
- If the following disc or card is inserted, the Disc Navigation screen will appear or some message will be displayed:
 - Write-protected disc
 - Finalized DVD-R disc
 - Locked card
- Do not leave the disc navigation screen displayed on TV to which the DVD video camera/recorder is connected: Doing so could damage the TV screen, possibly by burning.

PLAYING BACK FROM DISC NAVIGATION SCREEN

1 Press the DISC NAVIGATION button.

2 Use the ◀◀/▶▶/◀◀/▶▶ buttons to select the desired scene.

The selected scene will be framed: This is called a “cursor”.

3 Press the ▶/|| button.

Playback will start from the selected scene.

Note:

Pressing the ◀◀ or ▶▶ button will move the cursor to the preceding or following scene.

Pressing the ◀◀ or ▶▶ button will move to preceding or following page.

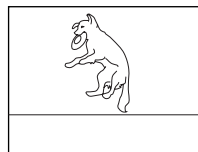
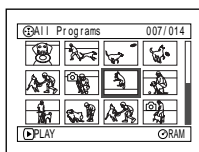
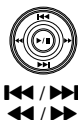
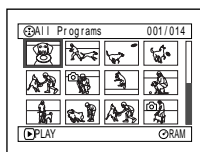

● When playback ends:

The DVD video camera/recorder will enter the playback pause status at the last image of last scene. Pressing the ■ or DISC NAVIGATION button will restore the Disc Navigation screen. When the playback pause status continues for as long as 5 minutes, the Disc Navigation screen will automatically be restored.

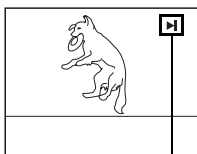

Playback pause

Note:

- Press the ▶/|| button to temporarily stop playback. Pressing ▶/|| again will start from that point.
- If you press the ▶/|| button after playback of the last scene on disc finishes, playback will start again from the beginning of disc.
- Pressing the ■ button will always restore the Disc Navigation screen.
- When playing back photos on card, “Playback” will appear. In the case of a photo with a large number of pixels, it will take some time for the photo to appear.

● Playing back photos

A photo on DVD-RAM disc will be displayed for approx. 3 seconds. When playing back photos on card, playback will stop after each photo playback.

SELECTING MULTIPLE SCENES

- 1 Press the DISC NAVIGATION button.
- 2 Use the **◀◀/▶▶/◀◀/▶▶** buttons to select the desired scene.
- 3 Press the SELECT button once:

The selected scene will be framed in red and yellow.

Repeat steps 2 and 3 to randomly select multiple scenes.

SELECTING CONSECUTIVE SCENES TOGETHER

- 1 Press the DISC NAVIGATION button.

- 2 Use the **◀◀/▶▶/◀◀/▶▶** buttons to select the desired scene.

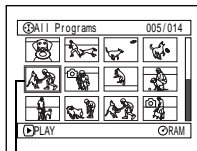

Yellow frame

- 3 Hold down the SELECT button for at least one second:

The selected scene will be doubly framed in yellow and blue.

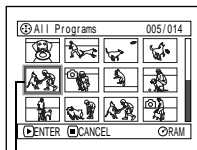

Double frames in yellow and blue

- 4 Use the **◀◀/▶▶/◀◀/▶▶** buttons to select the last scene in the range you want, and then press the **▶/||** button:

The thumbnails of scenes in the specified range will be framed in red, and then selected.

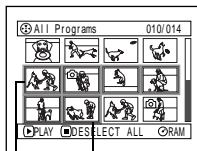

Red frame

When scenes up to this point are selected

Note:

- You can know the status of scenes from the colors of cursor and bargraph:

Cursor	Bar graph	Status of scenes
Yellow	Light blue	Current cursor position
Blue	Light blue	Range of scenes being selected
Red	Red	Scenes already selected

- Pressing the **▶/||** button after selecting scenes will play back only the selected scenes from the beginning of each.
- To cancel a selected scene, select the scene to be canceled, and then press the SELECT button. To cancel all selected scenes, press the **■** button.
- You can also select scenes in reverse from the last scene in the range.
- To release multiple selection, press the **■** or SELECT button before pressing the **▶/||** button in step 4.
- Up to 999 scenes can be selected for both disc and card.

FUNCTIONS AVAILABLE WITH DISC NAVIGATION

The Disc Navigation mode will allow a variety of further operations.

Available function	Disc or card used	Contents	Reference page
Editing of scenes	RAM	You can delete unnecessary scenes, combine scenes, or divide one scene.	110 – 113
Setting special effects to scenes	RAM	You can attach fade and skip to a scene, and change existing thumbnails.	114 – 116
Scene information display	RAM R CARD	You can display information on one scene or multiple scenes, such as image quality, recording time, etc.	120
Changing title	RAM	You can change the title of play list or program.	122, 130
Creation of play list	RAM	You can create an original movie by changing the combination of scenes.	124
Disc or Card initialization	RAM CARD	You can initialize a DVD-RAM disc or card so that it can be used on this DVD video camera/recorder.	132
Copy from disc to card	RAM CARD	You can copy photos recorded on DVD-RAM disc to card.	117
Disc finalization	R	You can use this DVD video camera/recorder to finalize any DVD-R disc recorded on it so that the disc can be viewed on DVD player, etc.	135
Repeat play	RAM R	You can repeatedly play back programs and scenes.	136
Slide show	CARD	You can play back stills continuously.	137
Remaining display (Capacity)	RAM R CARD	The remaining recordable movie time or number of recordable stills is displayed.	133
Disc protection	RAM	You can protect the DVD-RAM disc to prevent deletion or editing by mistake.	133
Deleting scene	CARD	You can delete unnecessary scenes.	110
Scene lock	CARD	You can lock any scene so that it will not be deleted by mistake: Essential scenes are thereby protected, and recording another still is possible.	118

Note:

Setting special effects to scenes (fade, skip, thumbnail) are unique to this DVD video camera/recorder. When a disc with any effects set on this DVD video camera/recorder is directly played back on a DVD recorder/player or read into PC, the set effect results will not be reflected in the playback or reading. To reflect the set effect results, connect both devices using the AV/S input/output cable and then perform recording (Dubbing, p. 83).

UNDERSTANDING FLOW OF DISC NAVIGATION MENU

Press the MENU button on the Disc Navigation screen: The menu screens for Disc Navigation and menu screens for disc and card will appear.

See "Checking Flow of Normal Menu" on page 84.

Refer to pages indicated for details of settings.

● When using DVD-RAM disc

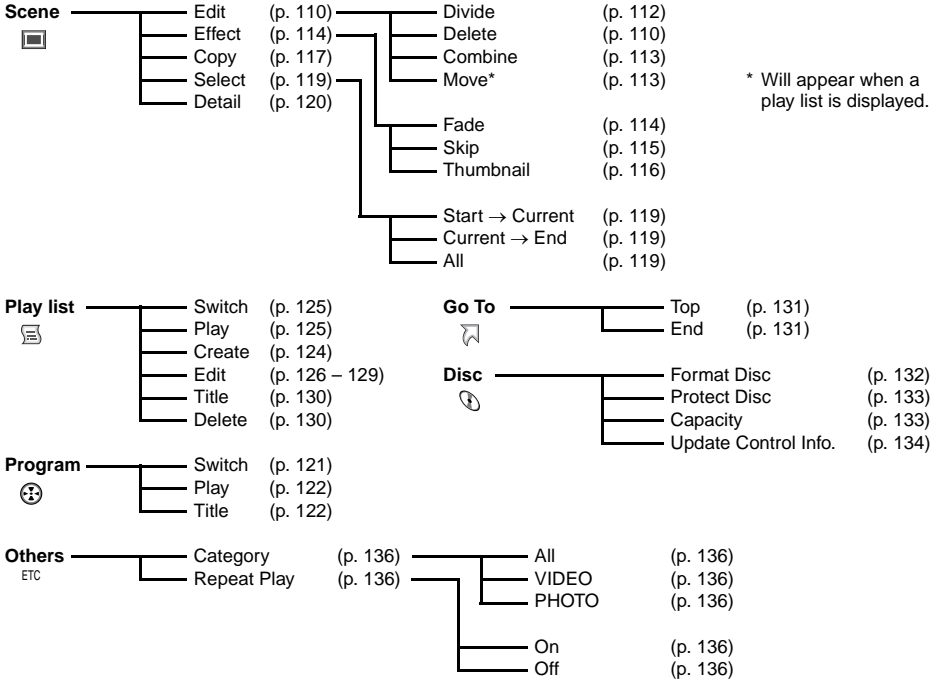

● When using DVD-R disc

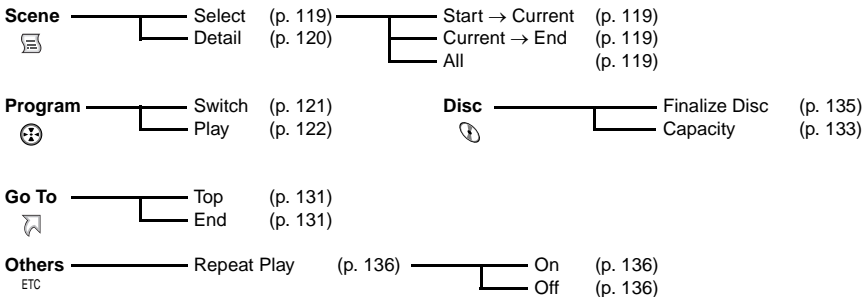

● When using card

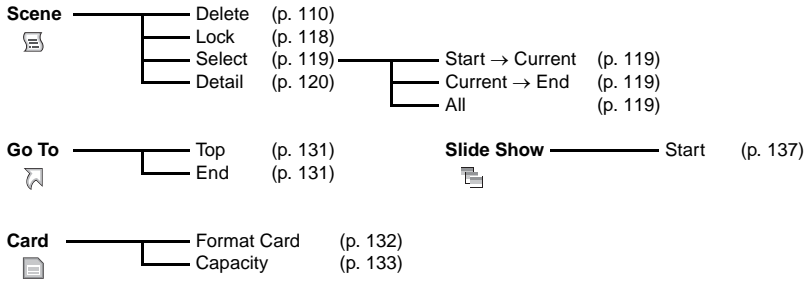

DELETING SCENES (EDIT – DELETE)

You may want to delete unwanted scenes.

Scenes on DVD-R disc cannot be deleted, and menu item “Delete” will not appear with DVD-R disc.

1 Press the DISC NAVIGATION button.

2 Select the scene to be deleted.

3 Press the MENU button.

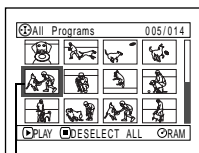

Scene to be deleted

4 Choose “Scene”, “Edit”, “Delete”, and then press the ►/|| button.

When using card, choose “Scene”, “Delete”, and then press the ►/|| button.

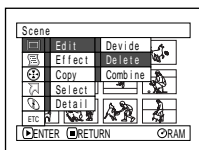

5 The “Delete Scene” screen will appear: If you are sure you want to delete the selected scene, press the ►/|| button.

If you want to change the scene to be deleted, you can change it on this screen.

6 The screen for verifying deletion will appear: Choose “YES”, and then press the ►/|| button.

Choose “NO” to cancel deletion.

After Yes or No setting, the “Delete Scene” screen will be restored.

Repeat steps 5 and 6 to delete other scenes.

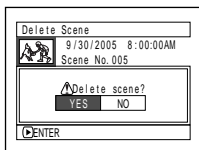

7 Press the ■ button to quit.

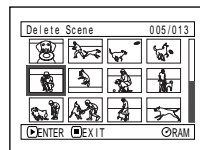

Note:

- If you point the cursor at the scene to be deleted on DISC NAVIGATION screen, and then press the DELETE button on remote control, the screen in step 5 will appear.
- To delete an unwanted part of a scene on DVD-RAM disc, divide the scene first, and then delete the unnecessary part (see page 112).
- If you delete all data on disc or card, initializing the disc or card will be recommended (see page 132).
- If the time of deleted scenes (stills) is quite short, the remaining free space of disc may not increase in the disc or card remaining indicator.
- The locked scenes on card cannot be deleted (see page 118).

● Editing using submenu

Press the MENU button before pressing the ►/|| button in step 5 (see page 110): The submenu will appear.

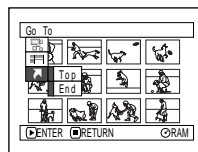
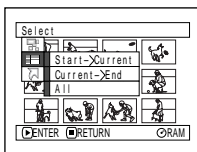
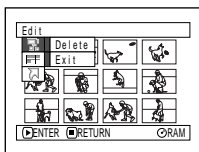

- Edit
 - Delete To delete selected scenes
 - Exit..... To restore the Disc Navigation screen
- Select
 - Start → Current.. To select scenes from the start to the one that the cursor is on at the moment
 - Current → End... To select scenes from the scene the cursor is on to the end
 - All To select all scenes
- Go To
 - Top To move the cursor to the first scene
 - End..... To move the cursor to the last scene

Pressing the ■ button will restore the screen in step 5.

Note:

Although the submenu screen will appear for each setting, some menu items may not appear, depending on the setting.

DIVIDING MOVIES (EDIT – DIVIDE)

You can divide a scene into two parts.

To delete unnecessary portion of scene, first divide the scene, and then delete the unnecessary portion.

1 Press the DISC NAVIGATION button.

2 Select the scene to be divided.

3 Press the MENU button.

4 Choose, “Scene”, “Edit”, “Divide” and then press the ►/|| button.

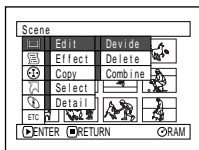

5 The “Divide Scene” screen will appear: If you are sure you want to divide the selected scene, press the ►/|| button: The selected scene will be played back.

If you want to change the scene to be divided, you can change it on this screen.

6 When you reach the point where you want to divide the scene, press the SELECT button.

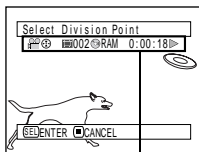

The status bar of scene being played back can be switched off or on by pressing the DISPLAY button

7 The screen for verifying division will appear: Choose “YES”, and then press the ►/|| button.

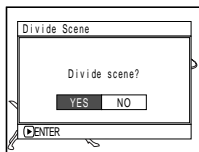

Choose “NO” to cancel division.

After division, the “Divide Scene” screen will be restored.

Repeat steps 5 – 7 to divide another scene.

8 Press the ■ button to quit.

Note:

- If you press the MENU button before pressing the ►/|| button in step 5, the submenu will appear (see page 111).
- Search and frame advance are useful when designating division points.
- Combining scenes that were divided will restore the original scene (see page 113).
- If a special effect has been added to the original scene, the “IN” effect will be added to the first half of scene, and the “OUT” effect, to the latter half.
- The division point may drift before or after the designated point by approximately 0.5 seconds.
- Since a scene with a skip set cannot be played back, no division point can be specified: Release the skip for the scene before dividing it.
- If the division point is at a still, a message will appear, but no division will be made.
- If the division point is at the start or end of a scene, a message will appear, but no division will be made.
- A movie scene whose recording time is 0.5 seconds or less cannot be divided.
- If free space available on disc is insufficient, division will not be possible: Delete unnecessary scenes.

COMBINING MULTIPLE SCENES (EDIT – COMBINE)

If you have recorded numerous short scenes, combining them will be facilitated by the use of Disc Navigation.

Be sure to select consecutive multiple scenes. Combining scenes is possible only when “Category: All” is specified (p. 136). Stills cannot be combined.

1 Press the DISC NAVIGATION button.

2 Select the consecutive multiple scenes to be combined.

See page 106 when selecting multiple scenes.

3 Press the MENU button.

4 Choose, “Scene”, “Edit”, “Combine” and then press the ►/|| button.

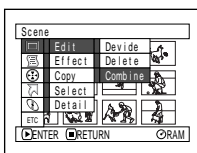

5 The “Combine Scenes” screen will appear: If you are sure you want to combine the selected scenes, press the ►/|| button.

If you want to change the scenes to be combined, you can change them on this screen.

6 The screen for verifying combination will appear: Choose “YES”, and then press the ►/|| button.

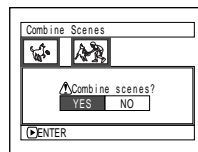

The two images appearing on the verification screen are those of the first and last scenes to be combined.

Choose “NO” to cancel combination.

After Yes or No setting, the “Combine Scenes” screen will be restored.

The thumbnail of the first scene will appear in the combined scene.

Repeat steps 5 and 6 to combine other scenes.

7 Press the ■ button to quit.

Note:

- If you press the MENU button before pressing the ►/|| button in step 5, the submenu will appear (see page 111).
- With fade effect, the “IN” effect of the first video in the selected range and the “OUT” effect on the last video will be attached to a combined scene.
- Scenes in different programs (different recording dates) cannot be combined: Create a play list first, and then combine such scenes on the play list.

ARRANGING ORDER OF SCENES (EDIT – MOVE)

You can arrange scenes within a play list by moving them to desired positions. (p. 129) Create a play list first, and then arrange the scenes [“CREATING NEW PLAY LIST (CREATE)”, p. 124].

DIRECTING SCENES EFFECTIVELY (EFFECT – FADE)

You can add fading to the beginning and/or end of scene.
There are three types of special effects:

Fade Out

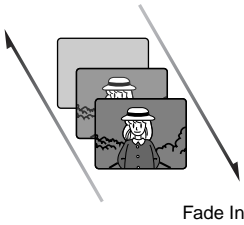

Fade In

White:

Fades in from white screen
Fades out to white screen

Fade Out

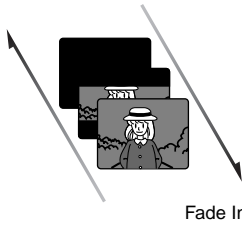

Fade In

Wipe:

Fades in from black screen to vertical direction of screen
Fades out from vertical direction of screen to black screen

Fade Out

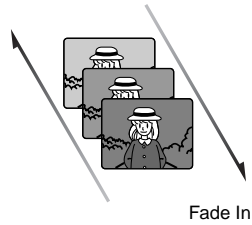

Fade In

B/W:

Fades in from Black and White screen to color screen
Fades out from color screen to Black and White screen

- 1 Press the DISC NAVIGATION button.
- 2 Select the scene for adding special effects.
- 3 Press the MENU button.
- 4 Choose, "Scene", "Effect", "Fade" and then press the ►/|| button.

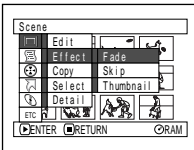

- 5 The "Fade Set" screen will appear: If you are sure you want to add the fade effect to the scene, press the ►/|| button.

If you want to change the scene to which fade is added, you can change it on this screen.

- 6 Select the special effects for "IN" and/or "OUT", choose "Enter", and then press the ►/|| button.

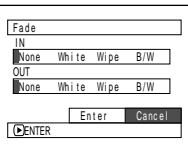

You can use ◀◀/▶▶ to move the cursor to "IN", "OUT", "Enter" or "Cancel".

Use ◀/▶ to choose the effect to be added, and then press ►/|| to set the effect.
To cancel setting, choose "Cancel".

If you choose "Enter" and press ►/||, the "Fade Set" screen will be restored after a message appears.
Repeat steps 5 and 6 to add fade to other scenes.

- 7 Press the ■ button to quit.

The "◀" and/or "▶" icon(s) will appear in the scenes for which fade in and/or fade out have been set.

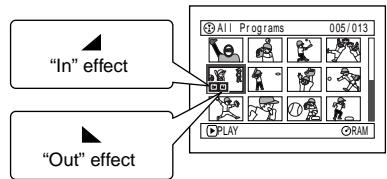

PLAYING BACK BY SKIPPING SCENES (EFFECT – SKIP)

You can specify “Skip” for scenes you do not want to play back: The selected scenes will be skipped.

1 Press the DISC NAVIGATION button.

2 Select the scene to be skipped.

3 Press the MENU button.

4 Choose “Scene”, “Effect”, “Skip”, and then press the ►/|| button.

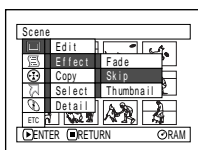

5 The “Set Skip” screen will appear: If you are sure you want to skip the selected scene, press the ►/|| button.

If you want to change the scene to be skipped, you can change it on this screen. After skip setting, the “Set Skip” screen will be restored.

Repeat step 5 to set skipping of other scenes.

6 Press the ■ button to quit.

A skip icon “≡” will appear in the thumbnail of any scene for which skipping has been set.

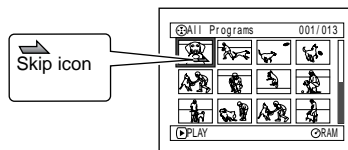

● Releasing Skip

Perform the same procedure as setting skip: The skip icon will disappear and skipping of the scene will be released.

Note:

- Multiple scenes can be selected for skipping (p. 106).
- If you press the MENU button before pressing the ►/|| button in step 5, the submenu screen will appear (p. 111).

CHANGING IMAGES FOR THUMBNAILS (EFFECT – THUMBNAIL)

Normally, the first image of the recorded scene is displayed as a thumbnail: You can choose another image of the scene for thumbnail. If you set a vivid image to thumbnail, you can know what you recorded from a glance at the Disc Navigation screen.

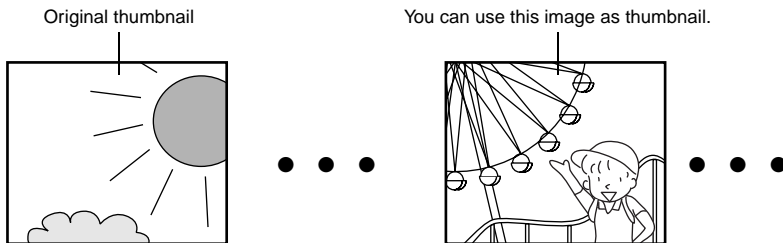

1 Press the DISC NAVIGATION button.

2 Select the thumbnail of the scene to be changed.

3 Press the MENU button.

4 Choose “Scene”, “Effect”, “Thumbnail”, and then press the ►/|| button.

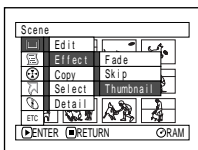

5 The “Change Thumbnail” screen will appear: If you are sure you want to change the thumbnail of the selected scene, press the ►/|| button: The selected scene will be played back.

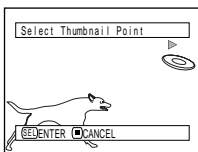

If you want to change the scene whose thumbnail is to be changed, you can change it on this screen.

6 When the image you want to use as the thumbnail of the scene appears, press the SELECT button.

7 The screen for verifying switching of thumbnail will appear: Choose “YES”, and then press the ►/|| button.

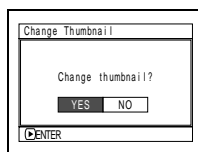

Choose “NO” to cancel switching of thumbnail.

After Yes or No setting, the “Change Thumbnail” screen will be restored.



Repeat steps 5 – 7 to change the other scenes.

8 Press the ■ button to quit.

Note:

- If you press the MENU button before pressing the ►/|| button in step 5, the submenu screen will appear. (See page 111)
- A thumbnail of still cannot be changed.
- Since the scene to which skipping is set cannot be played back, you will not be able to change its thumbnail: Release the skip setting of the scene to change the thumbnail.

COPYING STILL ON DVD-RAM DISC TO CARD (COPY)

- 1 Set the power switch to “” or “”.
- 2 Press the DISC NAVIGATION button.
- 3 Select the still to be copied.
- 4 Press the MENU button.
- 5 Choose “Copy” on the “Scene” menu screen, and then press the  button.

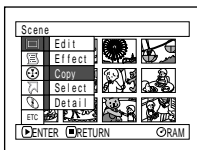

- 6 The “Copy to card” screen will appear: If you are sure you want to copy the selected still, press the  button.

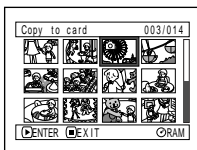

If you want to change the still to be copied, you can change it on this screen.

- 7 The screen for verifying copy will appear: Choose “YES”, and then press the  button.

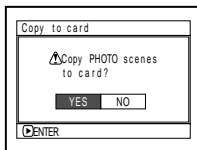

Choose “NO” to cancel copy.

After Yes or No setting, the “Copy to card” screen will be restored.

Repeat steps 6 and 7 to copy other stills to card.

- 8 Press the  button to quit.

Note:

- No movie can be copied.
- If you press the MENU button before pressing the  button in step 6, the submenu screen will appear (p. 111).
- See “Category” (p. 136) to check the stills recorded on DVD-RAM disc.
- You can also select multiple scenes (p. 106).
- Even if all scenes, including movies, are selected to be copied, only stills will be copied.
- Data on card cannot be copied to disc.
- The quality of still copied from disc to card will be the same as when you recorded still on disc.
- Stills recorded on a device other than this DVD video camera/recorder may not be copied normally.

LOCKING SCENES ON CARD (LOCK)

You can lock each photo recorded on card so that it will not be deleted or edited by mistake.

- 1 Set the power switch to “”.
- 2 Press the DISC NAVIGATION button.
- 3 Select the scene to be locked.
- 4 Press the MENU button.

- 5 Choose “Lock” on the “Scene” menu screen, and then press the  button.

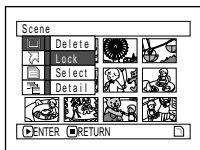

- 6 The “Lock Set” screen will appear: If you are sure you want to lock the selected scene, press the  button.

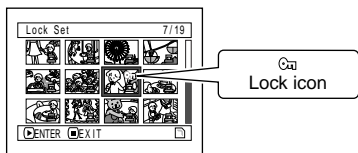

If you want to change the scene to be locked, you can change it on this screen. After setting, the “Lock Set” screen will be restored. Repeat step 6 to lock another scene.

- 7 Press the  button to quit.

The lock icon “” will appear on any scene for which lock has been set.

● To unlock the scene:

Select the locked scene, and then use the same procedure as above to unlock the scene: The lock icon will disappear and locking will be released.

Note:

- If you press the MENU button before pressing the  button in step 6, the submenu screen will appear (p. 111).
- You can also select multiple scenes (p. 106).
- When initializing the card, the locked scenes will also be deleted.

SELECTING SCENES USING MENU SCREEN (SELECT)

You can use this “Select” function to select consecutive scenes at one time. This function is useful when there are numerous scenes.

- 1 Press the DISC NAVIGATION button.
- 2 Point the cursor at the first or last scene to be selected: When selecting all scenes, simply proceed with step 3.
- 3 Press the MENU button.
- 4 Choose “Select” on the “Scene” menu screen.
- 5 Choose “Start → Current”, “Current → End” or “All” and then press the ►/|| button.

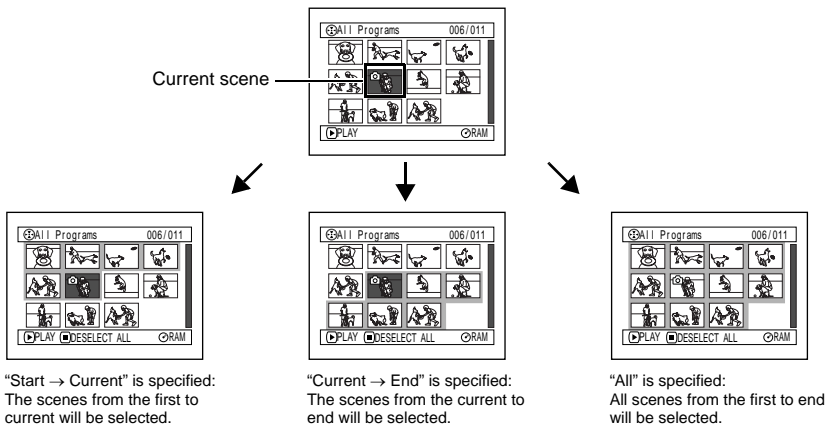
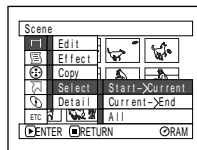

● Deselecting selected scenes

Deselecting scenes one by one:

While you are displaying the “All Programs” screen on which scenes have been selected, choose the scene to be deselected and then press the SELECT button.

Note:

Up to 999 scenes can be selected.

Deselecting all the selected scenes at once:

While you are displaying the “All Programs” screen on which scenes have been selected, press the ■ button.

DISPLAYING INFORMATION USING MENU SCREEN (DETAIL)

You can display various information for a scene: the recording mode, recording date/time and length, special effects and movie quality mode.

- 1 Press the DISC NAVIGATION button.
- 2 Select the scene whose information you wish to know.
- 3 Press the MENU button.
- 4 Choose "Scene", "Detail", and then press the ►/|| button.

The detailed information on the scene will appear.

(When using disc)

(When using card)

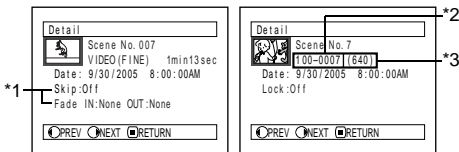

- *1 Not displayed with DVD-R disc.
- *2 May not appear if the loaded card does not comply with DCF.
- *3 Number of pixels on still in horizontal direction: This may not appear with a JPEG file that does not conform to this DVD video camera/recorder.

Note:

- DCF (Design rule for Camera File system) is a unified image file format for video cameras: Image files can be commonly used for all digital devices that conform to DCF.
- Pressing the ►► button will display information on the following scene; pressing the ◀◀ button will display information on the preceding scene.

- 5 Press the ■ button to quit.

Note:

- If multiple scenes have been selected, the total recording time of the selected scenes (total number in case of stills) will appear.

(When using disc)

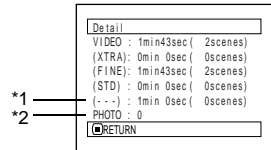

- *1 Number of scenes whose quality mode is unknown:
This will appear when the disc has a scene recorded on a device other than this DVD video camera/recorder, only if the disc has a scene whose mode is unknown.
Also, this will not appear when a DVD-R disc is used.
- *2 This will not appear with DVD-R disc, since no still image can be recorded on it.

(When using card)

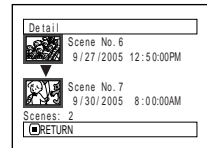

- If a DVD-R disc recorded on a device other than this DVD video camera/recorder is inserted (already finalized), no scene information will appear.

Program

WHAT IS “PROGRAM”?

Program refers to an assembly of scenes recorded on the same date regardless of whether they are movie or still.

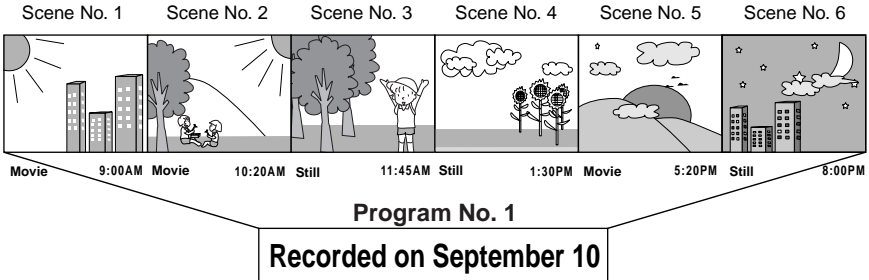

RAM R

SWITCHING TO THUMBNAIL DISPLAY OF SPECIFIC DATE (SWITCH)

Since the scenes recorded on this DVD video camera/recorder are collected as “programs” for each recording date, selecting a program will allow you to display only the scenes on a specific date.

1 Press the DISC NAVIGATION button.

2 Press the MENU button.

3 Use “Operating Menu” (p. 64) to choose “Switch” on the “Program” menu screen, and then press the ►/|| button.

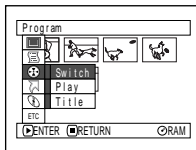

4 Select the program to be displayed, and then press the ►/|| button.

The Disc Navigation screen of the selected program will appear.

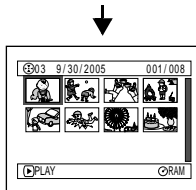
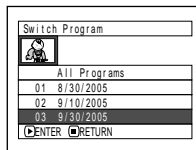

Note:

- Pressing the ■ button on the “Switch Program” screen will restore the Disc Navigation screen.
- If a DVD-RAM or DVD-R disc recorded on another device is loaded in this DVD video camera/recorder, the program may not be a collection of recordings on the same date.

PLAYING BACK PROGRAM (PLAY)

You can play back only the selected program.

- 1 Press the DISC NAVIGATION button.
- 2 Press the MENU button.
- 3 Use "Operating Menu" (p. 64) to choose "Play" on the "Program" menu screen, and then press the ►/|| button.

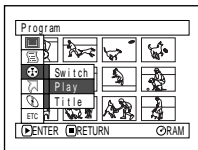

- 4 Select the program to be played back, and then press the ►/|| button.

Playback will start from the first scene of the selected program.

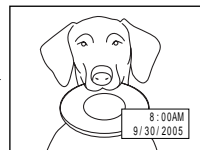
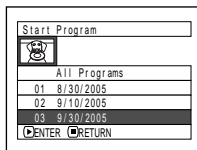

Note:

If "Repeat Play: On" is specified, the selected program will be repeatedly played back (PLAYING BACK SCENES REPEATEDLY (REPEAT PLAY), p. 136).

CHANGING TITLE OF PROGRAM (TITLE)

The recording date/time has initially been attached to any program. You can change the recording date/time to any desired title.

- 1 Press the DISC NAVIGATION button.
- 2 Press the MENU button.
- 3 Choose "Title" on the "Program" menu screen, and then press the ►/|| button.
- 4 Select the program whose title you want to change, and then press the ►/|| button.

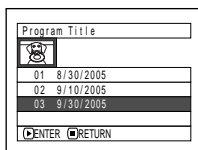

The screen for setting a title will appear.

- 5 Use ◀◀/▶▶/◀▶/▶▶ to select a letter, and then press the ►/|| button: The selected letter will be entered.

Repeat this procedure to create a title. Up to 20 characters can be input.

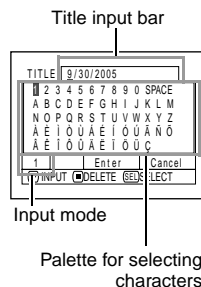

6 After entering the title, choose “Enter” and then press the **▶/||** button.

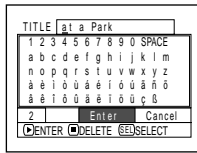

7 The screen for verifying the change in title will appear: Choose “YES”, and then press the **▶/||** button.



Choose “NO” to cancel changing of the title.

After Yes or No setting, the Disc Navigation screen of the selected program will appear.

Note:

- If you wish to delete the letter for title, press the **■** button once: The input letter will be deleted. Holding down the **■** button will delete all letters in the TITLE column.
- You can also use the DELETE button on remote control to delete any input letters.
- Pressing the SELECT button on the title setting screen (in step 5) will change the cursor position from the title input bar to character select palette, input mode number, and then to “Cancel”. You can also use **◀◀/▶▶/◀/▶** to move the cursor up/down and to the left/right and change its position.
- To cancel the setting of title, choose “NO” on the screen for verifying the entered title: The screen for verifying cancellation of title setting will appear. To cancel title setting, choose “YES”.
- If you press the **■** button on the screen for verifying change in title, the title setting screen will be restored.
- Double byte characters set on other devices may be displayed blank on this DVD video camera/recorder.
- Titles set on this DVD video camera/recorder may not be visible on other devices.

● Characters available for entering title

You can use the SELECT button to select characters from the “capital letter”, “small letter” and “symbol” input modes.

With step 5, select the input mode and then press the **▶/||** button, or press the DISPLAY button.

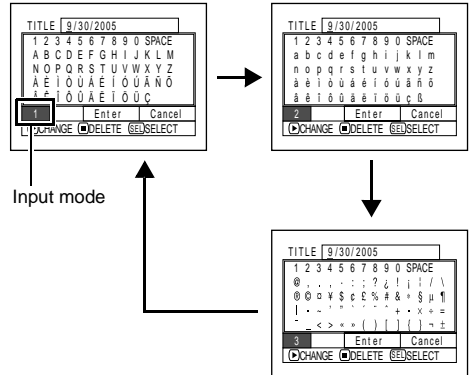

Play List

WHAT IS “PLAY LIST”?

You can create a play list on this DVD video camera/recorder by gathering your favorites from the recorded scenes.

Since the play list is not created by copying data, you will consume little of the disc capacity by making a play list. On the other hand, deleting scenes on play list will not increase the remaining disc capacity for recording.

Example:

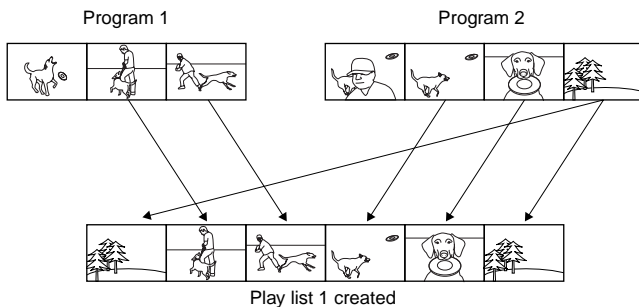

Play list of up to No. 99 can be created, and up to 999 scenes can be included in each play list of No. 1 to No. 99.

CREATING NEW PLAY LIST (CREATE)

- 1 Press the DISC NAVIGATION button.
- 2 Select the scenes to be programmed in a play list.
- 3 Press the MENU button.
- 4 Use “Operating Menu” (p. 64) to choose “Create” on the “PlayList” menu screen, and then press the ►/|| button.
- 5 The scene select screen will appear: If the selected scenes on the play list are the ones you want, press the ►/|| button.

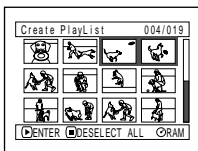
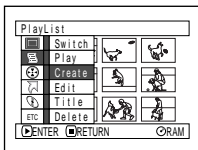

With the created play list, you can also add scenes recorded on another day or delete unnecessary scenes afterwards.

- 6 When creation of a play list is complete, the Disc Navigation screen will appear.

Note:

- You can also select multiple scenes (p. 106).
- If the added scene had skip or fade setting, that information will also be added to the play list.
- The date/time when a play list was created will appear as the title for the play list. This title can later be changed (p. 130).
- If free space available on disc is insufficient, creation of new play list may not be possible: Delete unnecessary scenes.
- Only the data on scenes is recorded on play list: **If you create or delete play lists, the original scenes in programs will not be erased.** Editing scenes on play list will not affect the scenes in programs.
- If you press the MENU button before pressing ►/|| in step 5, the submenu will appear (see page 111).

If you want to change the scenes with which you want to create a play list, you can change them on this screen.

SWITCHING TO DISPLAY OF EACH PLAY LIST (SWITCH)

Select the desired one of multiple play lists: The Disc Navigation screen of the selected play list will appear.

- 1 Press the DISC NAVIGATION button.
- 2 Press the MENU button.
- 3 Use “Operating Menu” (p. 64) to choose “Switch” on the “PlayList” menu screen, and then press the ►/|| button.

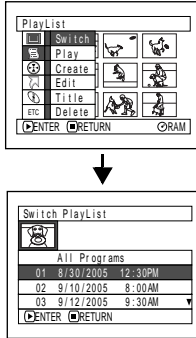

- 4 Use the “Switch Playlist” screen to select the play list you wish to display, and then press the ►/|| button.

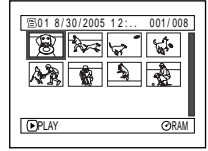

The Disc Navigation screen of the selected play list will be displayed.

Note:

To display the Disc Navigation screen showing all programs (all recorded scenes), choose “All Programs” on the “Switch PlayList” screen.

● Editing on play list

When making settings on play list, such as changing title, setting skip, adding fade, etc., use the same procedure for setting on program or scenes. Perform these settings, referring to the following reference pages:

Deleting scene,	p. 110
Changing thumbnail,	p. 116
Setting skip,	p. 115
Adding fade,	p. 114
Combining scenes,	p. 113
Dividing a scene,	p. 112
Copying to card,	p. 117
Changing title,	p. 122, 130
Arranging order of scenes (only on play list)	p. 129

PLAYING BACK A PLAY LIST (PLAY)

- 1 Press the DISC NAVIGATION button.
- 2 Press the MENU button.
- 3 Use “Operating Menu” (p. 64) to choose “Play” on the “PlayList” menu screen, and then press the ►/|| button.

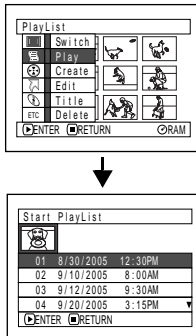

- 4 Use the “Start Playlist” screen to select the play list to be played back, and then press the ►/|| button.

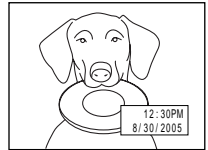

The selected play list will be played back from the first scene. To cancel playback midway, press the ■ button: The Disc navigation screen of the play list being played back will appear.

Note:

If “Repeat Play On” is specified, the play list will be repeatedly played back (see page 136).

ADDING SCENES TO PLAY LIST (EDITING PLAY LIST)

1 Press the DISC NAVIGATION button.

2 Press the MENU button.

3 Use "Operating Menu" (p. 64) to choose "Edit" on the "PlayList" menu screen, and then press the ►/|| button.

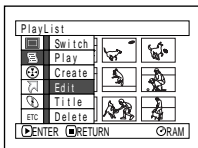

4 Use the play list select screen to select the play list to which you wish to add scenes, and then press the ►/|| button.

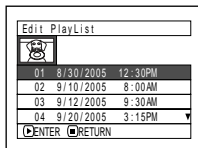

The scenes of the program that was displayed in step 1 will appear in the upper row, and the scenes of selected play list will appear in the lower row.

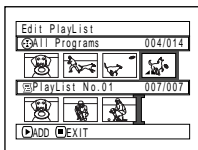

Note:

If the DISPLAY button is pressed when the thumbnails are displayed, the recording date/time of the selected scene will appear across the bottom of screen. Press DISPLAY button again to restore the previous screen.

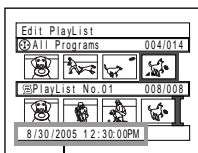

Recording date/time

5 Press the ►► button to move the cursor to the lower row, and press the ◀◀ or ►► button to select the point where the scene is to be inserted.

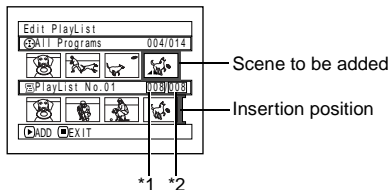

*1: Number of scene before insertion position cursor

*2: Number of all scenes on play list

6 Press the ◀◀ button to move the cursor to the upper row, and press the ◀◀ or ►► button to point the cursor to the scene to be added.

7 Press the ►/|| button to copy the scene.

After adding scenes is completed, the edited play list will appear.
Repeat steps 5 – 7 to add other scenes.

8 Press the ■ button: The screen for verifying exit will appear.

Note:

- The cursor shows the position where the scene is to be added.
- You can also select multiple scenes (p. 106).
- Pressing ■ in the middle of adding scenes will display the screen for verifying an exit from "Edit PlayList". Choose "YES" to exit the edition of play list. Choosing "NO" will restore the "Edit PlayList" screen.
- If you press the MENU button in step 5 or 6, the submenu screen for editing play list will appear. You can also use this submenu to add scenes (see page 111).

DELETING SCENES FROM PLAY LIST (EDITING PLAY LIST)

- 1 Press the DISC NAVIGATION button.
- 2 Display the editing screen of the play list to be edited.
Perform steps 2 – 4 on page 126.
- 3 Move the cursor to the play list in lower row, and place the cursor on the scene to be deleted.

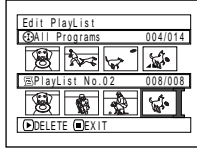

- 4 Press the ►/|| button.

Repeat steps 3 and 4 to delete other scenes.

- 5 Press the ■ button: The screen for verifying exit will appear.

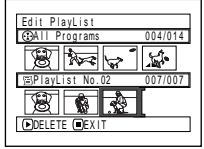

Note:

- You can also select multiple scenes (p. 106).
- Place the cursor on scene to be deleted, and then press the DELETE button on remote control: You can also delete the scene on the play list.

ADDING SCENES USING SUBMENU FOR EDITING (EDITING PLAY LIST)

You can use the menu screen to add scenes to a play list.

- 1 Press the DISC NAVIGATION button.
- 2 Display the editing screen of the play list to be edited.
Perform steps 2 – 4 on page 126.
- 3 From the play list in lower row, select the position where you wish to insert a scene.
- 4 Select the scenes to be added from the upper row.

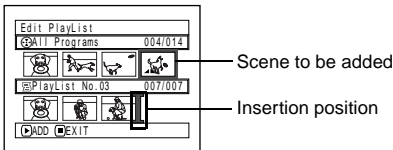

- 5 Press the MENU button.

- 6 Choose “Add”, and then press the ►/|| button.

Repeat steps 3 – 6 to add other scenes.

- 7 Press the ■ button: The screen for verifying exit will appear.

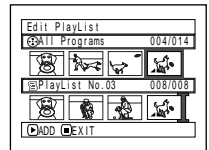
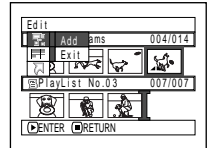

Note:

- The selected scenes will be added in the insertion position.
- You can also select multiple scenes (p. 106).

DELETING SCENES USING SUBMENU FOR EDITING (EDITING PLAY LIST)

You can delete scenes from play list on the editing screen.

- 1 Press the DISC NAVIGATION button.
- 2 Display the editing screen of the play list to be edited.

Perform steps 2 – 4 on page 126.

- 3 Move the cursor to the play list in lower row.

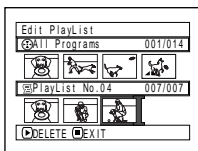

- 4 Select the scene to be deleted, and then press the MENU button.

- 5 Choose “Delete” on the “Edit” menu screen, and then press the ►/|| button.

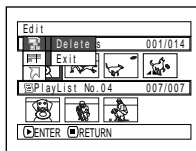

Repeat steps 3 – 5 other scenes can be deleted.

- 6 Press the ■ button: The screen for verifying exit will appear.

Note:

- If all scenes on play list are deleted, the play list itself will also be deleted.
- You can also select multiple scenes (p. 106).

SELECTING SCENES USING SUBMENU FOR EDITING (EDITING PLAY LIST)

You can specify the range of scenes when adding or deleting consecutive multiple scenes to/from play list. This “Select” menu item is useful when selecting consecutive multiple scenes in items for adding or deleting scenes using menu on page 119.

- 1 Press the DISC NAVIGATION button.

- 2 Display the editing screen of the play list to be edited.

Perform steps 2 – 4 on page 126.

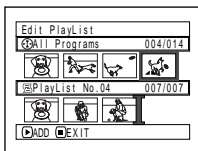

- 3 Specify the first or last scene of those you wish to select, and then press the MENU button.

To select all scenes, simply press the MENU button.

- 4 Use “Operating Menu” (p. 64) to choose “Start → Current”, “Current → End”, “All” on the “Select” menu screen, and then press the ►/|| button.

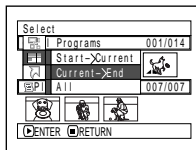

Note:

See page 119 for the status of scenes to be selected.

- 5 Press the ■ button: The screen for verifying exit will appear.

ARRANGING ORDER OF SCENES (MOVE)

You can move scenes only when “Category: All” is specified.

- 1 Press the DISC NAVIGATION button.
- 2 Press the MENU button.
- 3 Use “Operating Menu” (p. 64) to choose “Switch” on the “PlayList” menu screen, and then press the ►/|| button. Select the play list to be edited, and then press the ►/|| button.
- 4 Select the scene to be moved.

You can also select multiple scenes (see pages 106 and 119).

- 5 Press the MENU button.
- 6 Choose “Scene”, “Edit”, “Move”, and then press the ►/|| button.

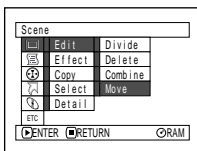

- 7 The “Move Scenes” screen will appear: If you are sure you want to move the scene, press the ►/|| button.

If you want to change the scene selected in step 4, you can do it on this screen.

- 8 Move the “I” mark to the position where you wish to move the scene, and then press the ►/|| button.

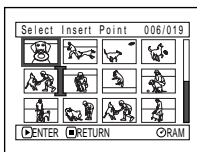

- 9 The screen for verifying move will appear: Choose “YES”, and then press the ►/|| button.

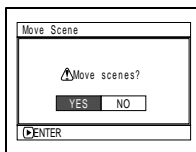

Choose “NO” to cancel move.

After Yes or No setting, the scene select screen will be restored.

Repeat steps 7 – 9 to move another scene.

- 10 Press the ■ button to quit.

Note:

- If you press the MENU button before pressing the ►/|| button in step 7, the submenu screen will appear (p. 111).
- You can also move multiple scenes (p. 106).
- Only scenes on play list can be moved.

CHANGING TITLE OF PLAY LIST (TITLE)

The play lists have serial numbers in the order you have created them, along with the created dates/times: You can change this title at any time.

- 1 Press the DISC NAVIGATION button.
- 2 Press the MENU button.
- 3 Use “Operating Menu” (p. 64) to choose “Title” on the “PlayList” menu screen, and then press the ►/|| button.
- 4 Use the “Playlist Title” screen to select the play list whose title you wish to change, and then press the ►/|| button.

See “CHANGING TITLE OF PROGRAM (TITLE)” on page 122 for how to enter a title.

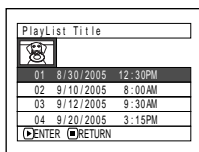

- 5 The screen for verifying exit will appear: Choose “YES” and then press the ►/|| button.



- 6 Press the ■ button to quit.

After changing the title, the Disc Navigation screen on the play list whose title has been changed will appear.

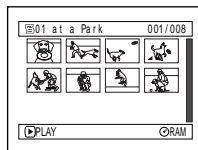

Note:

The registered title can be changed at any time using the same procedure.

DELETING PLAY LIST (DELETE)

- 1 Press the DISC NAVIGATION button.
- 2 Press the MENU button.
- 3 Use “Operating Menu” (p. 64) to choose “Delete” on the “PlayList” menu screen, and then press the ►/|| button.
- 4 Use the “Delete Playlist” screen to select the play list you wish to delete, and then press the ►/|| button.

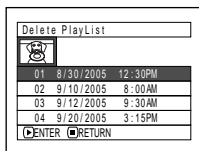

- 5 The screen for verifying deletion will appear: Choose “YES”, and then press the ►/|| button.

Choose “NO” to cancel deletion.

After Yes or No setting, the Disc Navigation screen of all programs will be restored.

Note:

- Even if you delete a play list, the original scenes stored on disc will not be deleted.
- If any play list is deleted, the number of play lists will automatically be revised. (For example, if the No. 2 play list is deleted, the No. 3 play list will become No. 2 play list.)

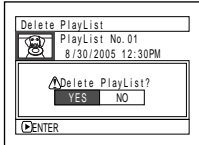

Go To

From the Disc Navigation screen, you can jump to the first scene or last scene.

TOP (END)

1 Press the DISC NAVIGATION button.

2 Press the MENU button.

3 Use “Operating Menu” (p. 64) to choose “Top” or “End” on the “Go To” menu screen, and then press the ►/|| button.

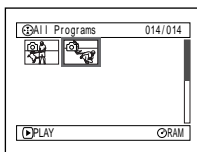
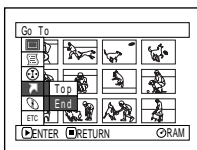

(When “End” is specified)

INITIALIZING DISC OR CARD (FORMAT DISC. FORMAT CARD)

Initializing DVD-RAM disc or card will allow you to delete any recorded contents.

Before You Begin

- Be sure to use the AC adapter/charger to power the DVD video camera/recorder for initialization. If the DVD video camera/recorder is turned off during initialization and the initialization is interrupted, incorrect initialization will result and the incorrectly initialized disc will be unusable.
- If you use a brand-new DVD-R disc, message “Disc is not formatted” will appear: Initialize the disc, following the subsequent messages (p. 46).

- 1 Press the DISC NAVIGATION button.
- 2 Press the MENU button.
- 3 Use “Operating Menu” (p. 64) to choose “Format Disc” or “Format Card” on the “Disc” or “Card” menu screen, and then press the ►/|| button.

The screen for verifying “Format Disc” or “Format Card” will appear.

- 4 Choose “YES”, and then press the ►/|| button.

Choose “NO” to cancel initialization.

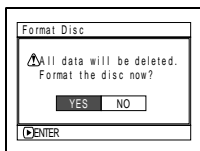

(When using DVD-RAM disc)

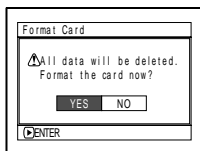

(When using card)

Note:

- If you wish to delete all recorded contents, it is recommended that you use initialization, which will delete all the scenes in much less time than using the scene delete function.
- Initialization will delete all the recorded contents on disc or card: Be careful not to delete data by mistake.
- It may not be possible to initialize a disc with many scratches or dirt: Such a disc cannot be used (p. 26).
- This DVD video camera/recorder may not recognize some discs or cards that have been initialized on PC or a device other than this DVD video camera/recorder.
- If you attempt to initialize a disc or card in this DVD video camera/recorder when it is connected to PC via PC connection cable, the disc or card may not be initialized and may be unusable on this DVD video camera/recorder (for DZ-GX20A or DZ-MV780A only).

PROTECTING DISC FROM WRITING (PROTECT DISC)

You can protect a DVD-RAM disc in order to prevent recorded images from being erased or edited by mistake. Further recording will not be possible on protected disc until the protection is released.

1 Press the DISC NAVIGATION button.

2 Press the MENU button.

3 Use “Operating Menu” (p. 64) to choose “Protect Disc” on the “Disc” menu screen, and then press the ►/|| button.

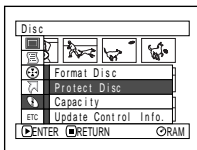

4 The screen for verifying protection will appear:

Choose “YES”, and then press the ►/|| button.

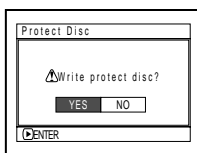

Choose “NO” to cancel protection. After “YES” or “NO” setting, the Disc Navigation screen will be restored.

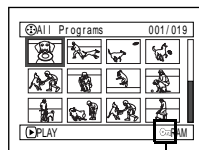

Disc protect icon

Note:

- To release disc protection, perform the same procedure as above: The screen for verifying the release of protection will appear. Choose “YES” to release the protection.
- If disc protection has been engaged on another device, it may not be releasable on this DVD video camera/recorder: Use the original device that protected the disc to release the protection.

VERIFYING REMAINING FREE SPACE ON DISC OR CARD (CAPACITY)

You can find out how long you will be able to record on one side of disc or on card.

1 Press the DISC NAVIGATION button.

2 Press the MENU button.

3 Use “Operating Menu” (p. 64) to choose “Capacity” on the “Disc” or “Card” menu screen, and then press the ►/|| button.

(When using disc)

(When using card)

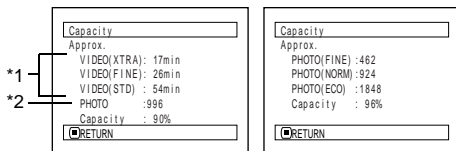

*1 With DVD-R disc: The quality mode first used for recording with disc will appear.

*2 With DVD-R disc: This will not be displayed.

4 Press the ■ button to quit.

The Disc Navigation screen will be restored.

Note:

With a write-protected disc (see “Terminology”, p. 155) or locked card, the remaining space will always be displayed as “0”.

UPDATING CONTROL INFORMATION OF DVD-RAM DISC (UPDATE CONTROL INFO.)

Disc Navigation in this DVD video camera/recorder handles information on scenes, such as thumbnail, skip, fade, in a particular manner. If you use another device to edit a disc recorded on this DVD video camera/recorder, and then use the data again with Disc Navigation in this DVD video camera/recorder, the Disc Navigation may not appear normally. If this happens, use the Update Control Info function to update the data.

Before You Begin

- When using the AC adapter/charger to power the DVD video camera/recorder for updating control information, make sure that power is not turned off during updating: If the DVD video camera/recorder is turned off during updating and the updating is interrupted, the control information will not be updated correctly.

- 1 Press the DISC NAVIGATION button.
- 2 Press the MENU button.
- 3 Use “Operating Menu” (p. 64) to choose “Update Control Info.” on the “Disc” menu screen, and then press the ►/|| button.

The screen for verifying “Update Control Info.” will appear.

- 4 Choose “YES”, and then press the ►/|| button.

The message for proceeding will appear, and then the Disc Navigation menu screen will be restored.

A black screen may appear while the message for updating is displayed. Choose “NO” to cancel updating.

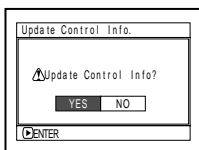

Note:

- It may take time to update the control information if the disc has many recorded scenes.
- Even if control information is updated, some discs will be unusable on Disc Navigation of this DVD video camera/recorder.

FINALIZING DVD-R DISC (FINALIZE DISC)

Before You Begin

- Be sure to use the AC adapter/charger to power the DVD video camera/recorder when finalizing a DVD-R disc. Finalization cannot be executed using a battery. If the DVD video camera/recorder is turned off during finalization and the finalization is interrupted, incorrect finalization will result, and at worst, the disc may be damaged.

If you want to play back a DVD-R disc recorded on this DVD video camera/recorder, using a device conforming to 8 cm DVD disc – such as a DVD player, etc. – you must finalize the disc on this DVD video camera/recorder. (See “Terminology”, p. 155)

The date of program will appear on the menu screen of DVD player as a title.

1 Press the DISC NAVIGATION button.

2 Press the MENU button.

3 Use “Operating Menu” (p. 64) to choose “Finalize Disc” on the “Disc” menu screen, and then press the ►/|| button.

The disc will be finalized.

4 Choose “YES”, and then press the ►/|| button.

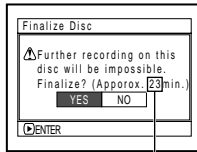

* Will vary depending on the recording time.

The message showing that the disc is being finalized will appear, and the disc will then be finalized.

Ⓢ will appear on the Disc Navigation screen for a finalized disc.

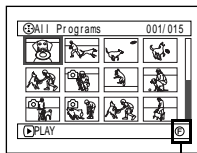

Finalized DVD-R disc

5 When finalization is complete, the Disc Navigation screen of all programs will appear.

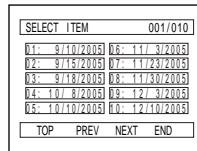

(Screen when viewed on DVD player)

Note:

- Do not finalize a disc recorded on this DVD video camera/recorder using any other device.
- No recording can be done on any DVD-R disc that has been finalized.
- If the disc in the DVD video camera/recorder has already been finalized, you cannot choose “Finalize Disc”.
- The time required to finalize disc that appears on the “Finalize Disc” screen is only for reference.
- The shorter the recording time on disc, the longer it will take to finalize it.

Others

DISPLAYING MOVIES OR STILLS INDEPENDENTLY (CATEGORY)

Scenes recorded on this DVD video camera/recorder will be displayed in the order of recording regardless of whether they are movies or stills. You can use the Disc Navigation screen to switch this display to stills only or movies only.

1 Press the DISC NAVIGATION button.

2 Press the MENU button.

3 Use “Operating Menu” (p. 64) to choose “Category” on the “Others” menu screen, and then press the ►/|| button.

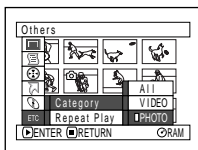

4 Specify the desired option for display, and then press the ►/|| button.

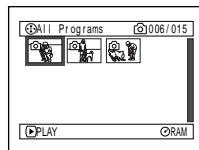

(When “PHOTO” is specified)

All: To display all scenes, movies or stills, in the order of recording.

VIDEO: To display only movies in the order of recording.

PHOTO: To display only photos in the order of recording.

When the Disc Navigation screen is finished, “Category: All” will be restored.

RAM R

PLAYING BACK SCENES REPEATEDLY (REPEAT PLAY)

1 Press the DISC NAVIGATION button.

2 Press the MENU button.

3 Use “Operating Menu” (p. 64) to choose “Repeat Play” on the “Others” menu screen, and then press the ►/|| button.

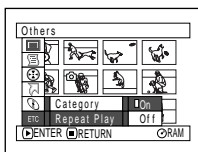

4 Choose “On”, and then press the ►/|| button: Playback will start.

Choose “Off” to cancel Repeat Play setting.

● When Repeat Play is set:

If one scene has been specified: When playback of the last scene is finished, playback of all scenes will repeat from the first scene.

If the range for playback has been specified: Playback of the scenes in that range will repeat.

● To release Repeat Play

Use one of the following 3 methods to release:

- Choose “Off” in step 4 above.
- Turn the DVD video camera/recorder off once.
- Press the DISC EJECT button to remove the disc.

Note:

- Press the ■ button to terminate playback. However, the Repeat Play setting will not be cancelled.
- Still images can also be played back repeatedly.
- Repeat playback will not function when playback is instructed from the recording pause status.

SLIDE SHOW (CONTINUOUS PLAYBACK OF STILLS)

If you play back stills recorded on a card, the DVD video camera/recorder will enter the playback pause status after each still is played back.

Setting Slide Show allows you to continuously play back stills.

1 Press the DISC NAVIGATION button.

2 Press the MENU button.

3 Use “Operating Menu” (p. 64) to choose “Slide Show”, “Start”, and then press the ►/|| button.

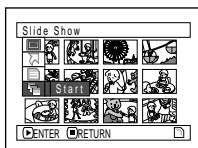

Note:

- One still is played for approx. 5 seconds.
- With slide show, playback will start from the first photo on card regardless of the position of cursor.
- If you press the ■ button or turn the DVD video camera/recorder off, Slide Show will be canceled.

Start: To start a slide show

When playback is finished, the DVD video camera/recorder will enter the playback pause status at the final still.

Pressing the ■ button will restore the Disc Navigation screen.

Connecting to PC (DZ-GX20A/DZ-MV780A)

THE FOLLOWING ARE AVAILABLE WHEN CONNECTING TO PC

Use the provided PC connection cable to connect this DVD video camera/recorder to your PC in which the software on the CD-ROM provided or generally available software is installed: The videos and photos recorded on the DVD video camera/recorder can be used on the PC.

● Using, on PC, the photos recorded on DVD-RAM disc or card in this DVD video camera/recorder:

Original disc	Application used
DVD-RAM disc or card recorded on this DVD video camera/recorder 	Application on which JPEG files can be used <ul style="list-style-type: none"> • Open the DCIM\100*HPNX1 folder of DVD-RAM disc or card.

● Viewing, on PC, DVD-RAM disc recorded on this DVD video camera/recorder:

Original disc	Application used
DVD-RAM disc recorded on this DVD video camera/recorder 	DVD-MovieAlbumSE** or generally available playback software conforming to DVD video recording (DVD-VR) format (see "Terminology", p. 155) Example: PowerDVD produced by CyberLink

● Viewing, on PC, DVD-R disc recorded on this DVD video camera/recorder:

Original disc	Application used
DVD-R disc recorded and finalized on this DVD video camera/recorder 	Generally available playback software compatible with DVD video (see "Terminology", p. 155) Example: PowerDVD produced by CyberLink

● Copying contents on DVD-RAM disc recorded on this DVD video camera/recorder to another DVD-RAM disc using PC:

Original disc	Written media	Application used
DVD-RAM disc recorded on this DVD video camera/recorder 	Another DVD-RAM disc	DVD-MovieAlbum copy tool** <ul style="list-style-type: none"> • Copy the data to hard disk of PC, and then write the data to another DVD-RAM disc. • Copying in program units is also possible.

● **Using PC to edit images on DVD-RAM disc recorded on this DVD video camera/recorder:**

Original disc	Written disc	Application used
DVD-RAM disc recorded on this DVD video camera/recorder 	Original DVD-RAM disc or another DVD-RAM disc	DVD-MovieAlbumSE**

● **Using PC to edit images on DVD-RAM disc recorded on this DVD video camera/recorder and create a DVD video (DVD-R disc) (see page 147):**

Original disc	Written disc	Application used
DVD-RAM disc recorded on this DVD video camera/recorder 	Blank DVD-R disc	<ul style="list-style-type: none"> • DVD-MovieAlbumSE** • DVDfunSTUDIO**

● **Capturing into PC, the images on DVD-RAM disc recorded on this DVD video camera/recorder (see page 147):**

Original disc	Application used
DVD-RAM disc recorded on this DVD video camera/recorder 	<ul style="list-style-type: none"> • DVD-MovieAlbumSE** • DVD-MovieAlbumSE copy tool**

* The number may be different when recording was made on a device conforming to DCF.

** Software stored on the provided CD-ROM

Note:

Images recorded on DVD-R disc cannot be edited on the software provided with this DVD video camera/recorder.

Languages compatible with each software program:

- DVD-MovieAlbumSE, DVDfunSTUDIO and UDF driver (DVD-RAM driver) can handle Japanese, English, German, French, Spanish, Italian and Chinese (simplified).
- 3D-TitleSTUDIO provided with DVD-MovieAlbumSE can handle Japanese and English.
- When installing the provided software, the language on your Windows® will automatically be installed: If your Windows® is run on a language other than the above, the English version will be installed.

Contents on Provided CD-ROM

The CD-ROM supplied with the DVD video camera/recorder contains the following folders:
To refer to the contents of CD-ROM, set the CD-ROM in the CD-ROM drive of PC, right-click the CD-ROM icon and choose "Open".

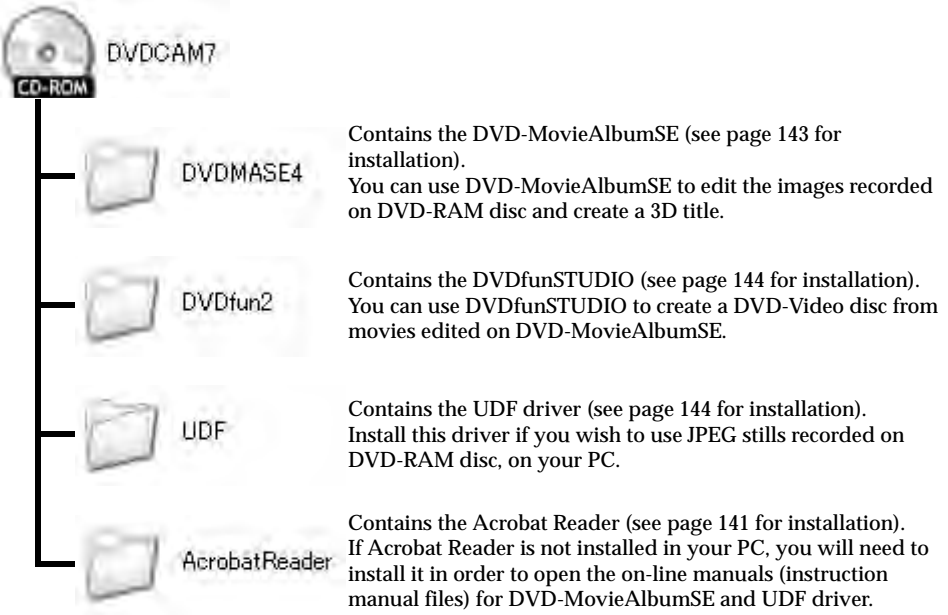

Although the CD-ROM may contain a folder or file other than the above, they will not be needed on this DVD video camera/recorder unless some special instruction is given.

● DVD-MovieAlbumSE

You can read the instruction manual using either of the following procedures:

- Open the PDF file in
DVIDMASE 4\manuals\English folder
contained on the provided CD-ROM.
- After installing DVD-MovieAlbumSE, open
“Programs” or “All Programs” from the
Windows “Start” menu, choose “Hitachi
DVDCAM” and “DVD-MovieAlbumSE”, and
then open “Instruction Manual”.

● DVDFunSTUDIO

- After installing DVDFunSTUDIO, open
“Programs” or “All Programs” from the
Windows “Start” menu, choose “Hitachi
DVDCAM” and “DVDFunSTUDIO”, and then
open the electronic instruction manual in
“Document” folder.

To read the above manual, you will need Adobe
Acrobat Reader.

If Adobe Acrobat Reader has not been installed
in your PC, start AcrobatReader\English
\AR500ENU.exe on the provided CD-ROM to
install it.

● UDF driver (DVD-RAM driver)

- After installing the UDF driver (DVD-RAM
driver), open “Programs” or “All Programs”
from the Windows “Start” menu, choose
“DVD-RAM” and “DVD-RAM Driver”, and
then open “How to use DVD-RAM disc”.

● Requirements of available PC

- The provided software cannot be used on Windows® 98 or Windows® 98 Second Edition.
- OS: Windows® Me / 2000 Professional / XP
- Computer: IBM PC/AT compatible
- CPU: Intel® Pentium® III 800 MHz or higher (Pentium® 4 1.8 GHz or higher is recommended)
Operation with Pentium compatible CPU other than those produced by Intel®/AMD® may not be
supported.
- Memory: At least 256 MB (512 MB or more is recommended)
- Free space on hard disk: At least 400 MB (does not include capacity needed to copy or edit video or
photo data)
- CD-ROM drive (used to install software)
- Display adapter (video memory of at least 4 MB) and display that can display at least 1024 × 768
pixels and 65,536 colors (16-bit colors), and is compatible with DirectX® 8.1 or higher.
- DirectSound® compatible sound card
- USB: One unused port is necessary for this product (USB2.0 port is recommended)

Note:

- Operation is not guaranteed in the following cases:
 - Using PC with OS other than Windows® Me / 2000 Professional / XP installed
 - When operated on Pentium® compatible CPU other than those produced by Intel® or AMD®
 - When connected via USB hub
- Multiprocessor is not supported.
- Even when your PC satisfies the above conditions of available PC, malfunction may result or restriction in use
may occur, depending on the combination of other software in PC or peripheral devices.

Installing Software

Before You Begin

Before installing the UDF driver (DVD-RAM driver) provided with this DVD video camera/recorder, check to see if another UDF driver* has already been installed on your PC.

*InstantWrite® provided with the DZ-WINPC1, DZ-WINPC2 or DZ-WINPC2B PC kit for the Hitachi DZ-MV100A DVD video camera/recorder, or with the DZ-WINPC3 PC editing kit for the Hitachi DZ-MV200A, DZ-MV230A or DZ-MV270A DVD video camera/recorder.

If the UDF driver has been installed, uninstall it and then install the UDF driver on the provided CD-ROM. Use “Control Panel” – “Add or Remove Programs” or “Add or Remove Applications” to uninstall the UDF driver.

If any question messages appear that mean “This file is not used on another application. Do you wish to delete it together?” during uninstalling, click “No” for all such questions.

Note:

- If your PC uses Windows® XP or 2000 Professional, set the user name to “Administrator (computer’s manager)” (or user name with equivalent authorization), log on to PC, and then install the software (if you do not have authorization, consult your system manager).
- For the software provided with this DVD video camera/recorder, no program with different version can coexist: If any programs with different versions are already installed in your PC, uninstall them, and then install the software from the provided CD-ROM. However, installing the provided software may disable some functions that were usable on the previously installed software programs with different versions.

DISPLAYING INSTALLER SCREEN

1 Turn the PC on.

If any software is being run on the PC, terminate all the programs being used.

2 Insert the provided CD-ROM into the CD-ROM drive of PC.

The installer screen will automatically appear.



If the installer screen does not automatically appear, use the following procedure to display it:

3 Use the Windows My Computer or Explorer to open the drive in which the CD-ROM is located.

4 Double-click the Setup.exe icon.

The “.exe” extension may not appear, depending on the PC being used.

INSTALLING SOFTWARE

1 Click “All” on the installer screen. Clicking “All” allows you to install the DVD-RAM driver, DVD-MovieAlbumSE 4.1 and DVDfunSTUDIO 2.2 all at one time. If any of the software programs are already installed, uninstall them, and then proceed with installing the provided programs.

2 The screen for installing DVD-MovieAlbumSE will appear: Click “Next”.



3 Choose your TV broadcast system, and then click “Next”.

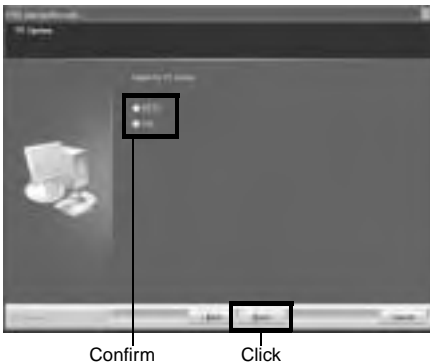

4 If you do not wish to change the folder in which DVD-MovieAlbumSE is installed, click “Next”. If you wish to change the folder, click “Change”, and then choose the folder in which DVD-MovieAlbumSE is to be installed.



5 Click “Install”. Installation will start.

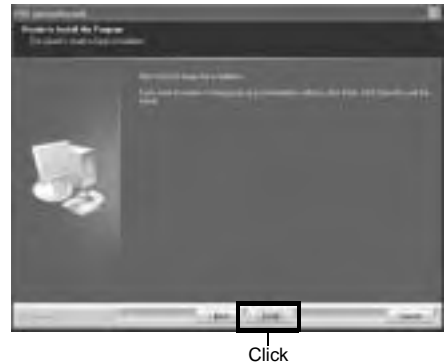

- 6** A message verifying whether a shortcut icon is to be created on desktop will appear: If you want to create one, click "Yes". If not, choose "No".



- 7** Click "Finish". Then the installation of DVDfunSTUDIO will start.

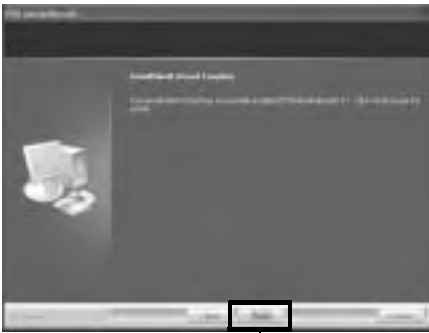

Click

- 8** The screen for installing DVDfunSTUDIO will appear: Click "Next".

- 9** If you do not wish to change the folder in which DVDfunSTUDIO is installed, click "Next". If you wish to change the folder, click "Change", and then choose the folder in which DVDfunSTUDIO is to be installed.

- 10** Click "Install". Installation will start.

- 11** A message verifying whether a shortcut icon is to be created on desktop will appear: If you want to create one, click "Yes". If not, choose "No".

- 12** Click "Finish". Then the installation of DVD-RAM driver will start.

- 13** After the DVD-RAM driver has been installed, a message that prompts you to restart the PC will appear: Click "OK".

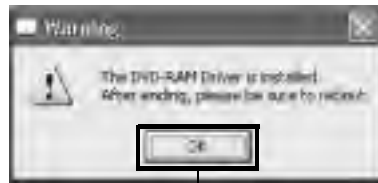

Click

- 14** The driver setup screen will appear: Click the "Driver and Formatter Setup" button.

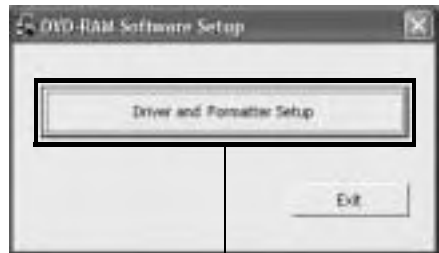

Click

15 Click "Next".



Click

16 Carefully read the License Agreement: If you accept it, click "Yes".

The contents of agreement displayed on actual screen may be different from those in the figure.

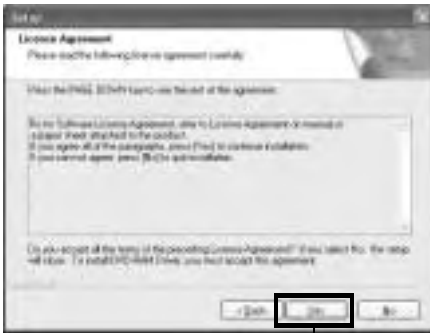

Click

17 If you do not wish to change the folder in which the UDF driver is installed, click "Next".



Click

18 If you do not wish to change the folder name, click "Next".



Confirm

Click

- 19 Check the displayed contents, and then click “Next”.



Click

- 20 Installation will start. When installation is complete, some notes will appear: Check the contents, and then click “x” at the top right of window.

The contents displayed on actual screen may be different from those in the figure.



Click

- 21 If your PC uses Windows® XP/Me, a message that prompts you to restart will appear: Click “Finish” and then restart the PC.

Installing the UDF driver is now complete.

If your PC uses Windows® 2000 Professional, proceed with step 22.

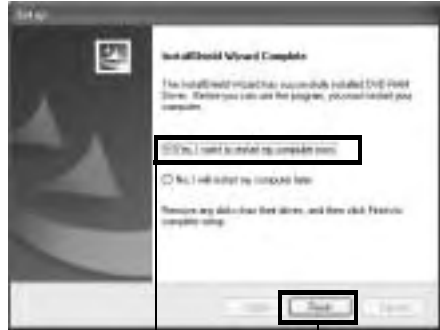

Confirm

Click

- 22 If your PC uses Windows® 2000 Professional, a message announcing the start for detecting device will appear: Click “Finish” to start the detection of device.

It may take several minutes for PC to detect the device. When detection of the device is complete, a message that prompts you to restart will appear: Click “Yes” to restart the PC.

Installing the software is now complete.

Note:

- If software that detects computer virus, etc., has been installed, invalidate it.

Creating DVD Video from DVD-RAM Disc Recorded on DVD Video Camera/Recorder

Using DVD-MovieAlbumSE and DVDfunSTUDIO, you can create a DVD video (DVD-R disc) from the images recorded on this DVD video camera/recorder, following the procedure below:

- 1 Insert a recorded DVD-RAM disc into the DVD video camera/recorder, and connect the DVD video camera/recorder to the USB terminal of PC.
- 2 Start DVD-MovieAlbumSE, and edit the images on DVD-RAM disc as necessary.
- 3 Right-click the thumbnail from which you wish to create a DVD video on the DVD-MovieAlbumSE screen, and execute "Export".
- 4 The "Program Export" screen as shown below will appear: Perform settings for export.

For settings on "Resolution" and "Audio" in the "Export Mode" box, choose the options with "Recommendations" displayed. If you change the folder name in "Destination Folder" column, you can also change the folder in which the exported file will be stored.



"Program Export" Screen

Click

Note:

- Choose "Divide by Chapter" in the "Option" box: Each scene of program recorded on the DVD video camera/recorder will be saved as an independent movie file so that export can be executed at high speed. If you do not choose "Divide by Chapter", movie files may be unified and re-encoded, so it may take time to export them. DVD-MovieAlbumSE may automatically re-encode a movie recorded in the XTRA mode containing rapidly moving scenes, regardless of the "Divide by Chapter" setting, and it may take some time to export the movie file.
- Any disc on which scenes were combined (see page 113) on Disc Navigation of this DVD video camera/recorder is re-encoded, so it may take time to export files.
- Re-encoding may cause image degradation.
- Do not choose "Simple Export" in the "Export Mode" setting box: Choosing it may stop export midway.

- 5 Click the Start button to start export.
- 6 When export is complete, message "The file exporting was completed successfully. Do you wish to create a 'DVD-Video' disc" will appear. Check the small box for "Eject the disc being used", and then click "Yes".
- 7 The cover of disc insertion block will open: Remove the DVD-RAM disc, insert a brand-new DVD-R disc, and then close the cover of disc insertion block.

DVD-MovieAlbumSE will automatically end, and the "Export to Disc" screen will appear: Click the "Start" button.

- 8** DVDfunSTUDIO will automatically start. The following Collect Tool will appear: Click "OK".



Any scene exported on DVD-MovieAlbumSE will be automatically registered on DVDfunSTUDIO.

You can now change the DVD menu to the desired style, change the title, choose the size of disc to be used (8 cm/12 cm/12 cm double-layered) and the playback method. Refer to the DVDfunSTUDIO instruction manual for details.

- 9** Click the Burn button: Writing to DVD-R disc will start. When writing is complete, a DVD video disc will be created. Then the disc cover of this DVD video camera/recorder will open automatically.



Note:

- The menu screen created on DVDfunSTUDIO will not appear on this DVD video camera/recorder. Also, depending on the written contents, the images may not be playable on this DVD video camera/recorder. In such cases, use a standard DVD player to display the created menu.
- Although DVDfunSTUDIO is compatible with DVD-RW and 12 cm/12 cm double-layered DVD discs, these discs cannot be used on this DVD video camera/recorder.
- The following table shows the recordable time on 8 cm DVD-R disc from DVDfunSTUDIO.

Movie quality mode of DVD-RAM disc in DVD video camera/recorder	Recordable time on 8 cm DVD-R disc (using DVDfunSTUDIO)
STD	Approx. 50 minutes
FINE	Approx. 25 minutes
XTRA	At least 18 minutes

- * If there are many thumbnails, the recordable time will be less than that shown in the above table.
- A DVD video can be created from MPEG files on PC using DVDfunSTUDIO, but it may not be playable on this DVD video camera/recorder.
- Although DVDfunSTUDIO can handle a wide-screen image recorded on this DVD video camera/recorder as is, a wide-screen image recorded in the STD mode of this DVD video camera/recorder must be re-encoded.

Uninstalling Software

To uninstall (delete) any provided software that has been installed, use “Control Panel” to open “Add or Remove Applications”, choose the applications to be uninstalled from the displayed list of applications, and then click the “Change/Remove” button.

Note:

After uninstalling software, be sure to restart the PC.

Cautions When Using DVD Video Camera/Recorder by Connecting It to PC

Note:

- Do not use Windows® application to finalize a DVD-R disc recorded on this DVD video camera/recorder:
The disc will become unusable.
- When formatting a DVD-RAM disc on Windows®, use the UDF2.01 format (2.0 if 2.01 cannot be selected) (see “Terminology” on page 155). Formatting with other standards could cause the DVD video camera/recorder to malfunction.
- Before processing or editing photos, be sure to copy the JPEG files in 100HPNX1 folder to the hard disk of PC.
- Ordinary data on PC can usually be written to DVD-RAM disc in this DVD video camera/recorder, but Hitachi does not guarantee the operation.
- Data may be readable or writable from/to storage media in this DVD video camera/recorder using software other than that provided with this DVD video camera/recorder, but Hitachi does not guarantee the operation.
- If the PC is started from suspend (see “Terminology” on page 155) (or sleep or standby) with this DVD video camera/recorder connected to the PC, the DVD video camera/recorder may not be recognized: Disconnect the DVD video camera/recorder from PC once, and restart the PC.
- Multiple DVD video camera/recorders cannot be simultaneously connected to PC.
- Use a reference of approx. 30 minutes at approx. 86°F (30°C) or less for operation when connecting this DVD video camera/recorder to PC.
 - Use a reference of a continuous 30 minutes or less for write operation when using the DVD-MovieAlbum copy tool provided with DVD-MovieAlbumSE.
 - If the temperature of this DVD video camera/recorder is too high, writing or reading on this DVD video camera/recorder may be faulty. And in particular, note that, if an error occurs during writing to DVD-R disc, the disc will not be usable. Take care that the temperature of this DVD video camera/recorder is not too high.

Introduction to Video Editing Software

The following introduces the software (generally available) you can use with PC to edit videos recorded on this DVD video camera/recorder. The information on the product on this page is for reference only; Hitachi does not guarantee or endorse the operation of a given product. Contact the software company for any inquiries on the specifications and operation requirements of the product.

● For Mac

PIXELA CORPORATION

“Pixe VRF Browser”

Information on product: http://www.pixela-1.com/vrf_browser.htm

You can capture videos recorded on a DVD-RAM disc using this DVD video camera/recorder into a Mac and edit them (capturing videos recorded on DVD-R is not possible).

Note:

- This DVD video camera/recorder cannot be connected to a Mac via USB. When using a DVD-RAM disc recorded using this DVD video camera/recorder on Mac, it is recommended that you use the DVD-Multi (or DVD-RAM) drive of the above PIXELA CORPORATION.
- A DVD-RAM disc written using the above software may not be playable on this DVD video camera/recorder. In such a case, play it back on a generally available DVD recorder, DVD player or PC.
- The information on this page is as of January, 2005. The name and specifications of a product may change. Visit the above website for the latest information.

Subsidiary Information

Introduction to Optional Accessories

CAMERA ACCESSORIES

Wide conversion lens (DZ-WL1)*



Tele-conversion lens (DZ-TL1)*



Video flash (DZ-FLH3)**



Step-up ring
(DZ-SR3437 for DZ-GX20A or DZ-MV730A, DZ-SR3037
for DZ-MV780A)

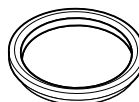

- When using camera accessories, be sure to read the instruction manuals for each accessory.
- * When attaching the wide or tele-conversion lens to this DVD video camera/recorder, you will need the optional step-up ring: Attach it after removing the lens hood covering the lens (see p. 57).
- ** Unavailable for DZ-MV730A.

POWER SUPPLY

Battery (DZ-BP14SW)

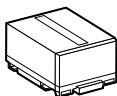

Battery (DZ-BP7SW)*

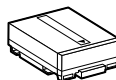

- * Unavailable for DZ-GX20A.

Removing Disc from Its Package

No disc in package – such as in DVD Round Holder, square cartridge or caddy case – can be used on this DVD video camera/recorder: Remove the disc from the holder, cartridge or caddy when using. The way to remove a disc from its package may vary with the disc maker: See the disc instruction sheet.

The following explains how to remove the discs made by Hitachi Maxell:

REMOVING AND REPLACING FROM/IN ROUND DVD HOLDER

- 1 Hold the Round DVD Holder with SIDE A facing up. While pushing the two release levers in the direction of arrows (1) marked on holder, slowly open SIDE A of the holder in the direction of arrows (2), taking care not to drop the disc.

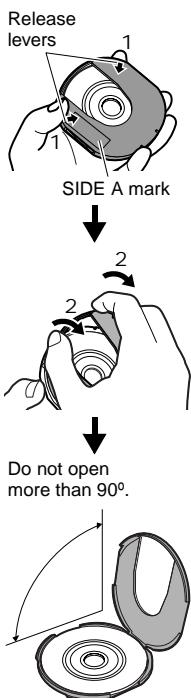

- 2 Without touching the recording surface, hold the disc edge and center hole to remove it.



REMOVING DISC FROM CARTRIDGE

1 Use a fine tipped pen, etc. to snap off the lock pins, and then remove them.

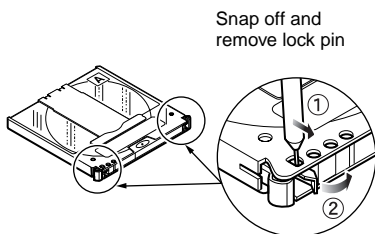

2 While pushing the release levers in the direction of arrows, gently pull out the holder with the disc, taking care not to drop the bare disc.

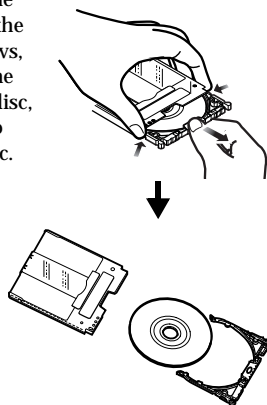

● Removing disc from caddy case

1 Insert your finger into the hole in the center of disc, taking care not to touch the recording surface, and slide the disc obliquely upward so that it is not caught by claws.

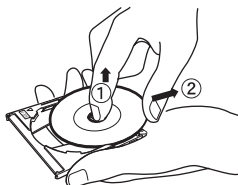

Cleaning

Be sure to set the power switch to "OFF" before cleaning this DVD video camera/recorder.

● Cleaning LCD screen and camera lens

Use dry, soft cloth to wipe dirt off. When cleaning the LCD screen, be careful not to use force, scratch it, or subject it to impact: Doing such could cause a defect in the screen, result in display unevenness, or damage the LCD monitor.

● If dust adheres to the viewfinder lens, remove it using a cotton swab, etc.

Do not rub the lens with force: Doing so could scratch the lens.

● Do not use benzene or thinner to clean DVD video camera/recorder case

The coating of case could peel off or the case could deteriorate. Wipe off dirt on the case with a moist cloth which has been completely wrung out. When using chemical cleaning cloth, follow instructions for use.

Changing Setting of Demonstration

This DVD video camera/recorder is equipped with a demonstration function.

The default at purchase time is "Auto", which will automatically start the demonstration approx. three minutes after the DVD video camera/recorder is turned on.

Use the following procedure if you wish to view the demonstration immediately or change the setting to "Off".

1 Press the MENU button.

2 Choose "Initial Setup", "Demo Mode", and then press the **▶/||** button.

3 Press the **◀◀** or **▶▶** button to choose the desired option, and then press the **▶/||** button.

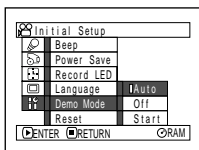

Note:

- You can press the DISC NAVIGATION button to stop demonstration midway: The Disc Navigation screen will appear.
- If you choose "Auto", the demonstration will not start if a disc is loaded with the power switch set to "⏻" or "⏻", or a card is loaded with the power switch set to "⏻".
- The demonstration function will not work when the DVD video camera/recorder is connected to PC (for DZ-GX20A or DZ-MV780A only).
- While the demonstration is being given, the recording indicator will blink.

Auto: To start demonstration approx. 3 minutes after turning the DVD video camera/recorder on.

Off: To set demonstration to off.

Start: To start demonstration immediately.

Press the MENU button again: The menu screen will disappear.

To stop the demonstration midway, press the **■** button.

The demo mode will end when the DVD video camera/recorder is turned off or the DISC EJECT button is pressed down.



DISC-PROTECT:

This disables writing to disc (protects disc from writing) so that images recorded on DVD-RAM disc cannot be accidentally deleted and the disc cannot be initialized.

DOLBY DIGITAL:

An audio recording format widely used for DVD video. Using this technology instead of PCM recording can enhance the recording capacity, which will allow user to achieve a recording of images with higher resolution (bit rate) or a longer recording time.

DVD PLAYER:

This device can play back video and audio signals recorded on DVD-Video and DVD-R discs using the DVD video format. Most DVD players can play back a DVD-R disc recorded on the DVD video camera/recorder (some DVD players cannot play back the disc).

DVD-R DISC:

One-time recordable DVD disc: The recorded contents cannot be deleted or overwritten. If recordable space remains on the disc, additional recording will be possible if the disc has not been finalized.

DVD-RAM DISC:

Rewritable DVD disc.

DVD RECORDER:

This device can record video and audio on any recordable DVD disc, such as DVD-RAM, that conforms to the DVD video recording format. Some DVD recorders can record on a DVD-R disc conforming to DVD video format. A DVD recorder that is compatible with 8 cm DVD-RAM can play back DVD-RAM discs recorded on the DVD video camera/recorder.

DVD VIDEO FORMAT:

This application format establishes the file name, directory structure, data format, etc. to record videos (movies). A generally available DVD video conforms to this format.

DVD VIDEO RECORDING (DVD-VR) FORMAT:

Format to record video data on writable DVD disc: This format has been adopted for DVD video camera/recorders, and DVD recorders that are compatible with DVD-RAM disc, etc.

FINALIZE:

This process makes a DVD-R disc recorded on this DVD video camera/recorder playable on a DVD player, etc. that conforms to 8 cm DVD-R: No further recording can be made on a finalized DVD-R disc.

HOWLING:

This phenomenon occurs as follows: When the DVD video camera/recorder is connected to a device, such as TV, the audio input to the microphone of DVD video camera/recorder is amplified and output from the speakers of TV, and the signal is again input to the microphone: This is repeated to form an endless loop of audio signal, and the signal is amplified up to the audio output amplitude limit of the device. Howling can be prevented by changing the positional relationship between the DVD video camera/recorder and TV, or by turning down the volume on TV.

INFRARED SENSOR:

This sensor is used to adjust the white balance.

LASER PICKUP BLOCK:

This block emits laser beam to a disc, and then collects the laser beam reflected from the disc to convert it to an electric signal. The block consists of a laser, lens, receiving element, etc.

LINEAR PCM:

Audio recording format similar to Dolby Digital: However, linear PCM does not compress an audio signal, but instead samples it and converts it to a digital signal to be recorded. Therefore, the amount of data used is larger than that of Dolby Digital.

MultiMediaCard:

This is a standard of memory card developed in 1997. The card is 32 mm long × 24 mm wide × 1.4 mm thick, and has 7 pins. It can be inserted into SD memory card slot and used.

SCENE:

Video (movie): “One scene” refers to images recorded from one press of REC button until recording is stopped by pressing the REC button again.

Photo (still): “One scene” refers to a single photo recording by pressing the PHOTO button.

SD MEMORY CARD:

This is a standard of memory card developed in 1999. The card is 32 mm long × 24 mm wide × 2.1 mm thick, and has 9 pins. Since the SD memory card was developed based on MultiMediaCard (MMC), MMC can be inserted into SD memory card slot and used. However, an SD memory card cannot be inserted in the slot exclusively for MMC.

SLOT-IN TYPE PC:

PC that has a DVD drive into/from which a DVD is directly inserted or ejected without using a tray.

SUSPENDING PC:

This function stores the status of PC before it is turned off: It will restart the work from the status immediately before PC was turned off, when the PC is turned on next time.

THUMBNAIL:

This refers to a reduced screen displayed on Disc Navigation in order to identify the recorded image contents.

UDF2.01 FORMAT:

UDF stands for Universal Disc Format: This is a world standard file format for optical storage defined by OSTA*. UDF revision 2.0 or 2.01 has been adopted for DVD-RAM disc to ensure compatibility with DVD recorders and PCs, as well as DVD video camera/recorders.







* Optional Storage Technology Association: An organization that is promoting writable optical storage.

VIDEO SELECTOR:

This device can input multiple audio and video signals, and select the desired audio and video signals among those input signals, to output them.

No DVD Video Camera/Recorder Operation – Check the Following:

Check 1	No movie can be recorded
<p>Movie can be recorded only on DVD-RAM or DVD-R disc.</p> <p>Check the following:</p> <ul style="list-style-type: none"> • Is proper type of disc inserted? • Is power switch set to “”? • Is the DVD-RAM disc in DVD video camera/recorder write-protected? Release the write-protect. • When using DVD-R disc: Has the disc been finalized? • Does disc have remaining recording space? <p>If movie still cannot be recorded after the above check is clear, the disc may be damaged: Use another disc.</p>	

Check 2	No still can be recorded
<p>Still can be recorded only on DVD-RAM disc or SD memory card.</p> <p>Check the following:</p> <ul style="list-style-type: none"> • Is proper type of disc or card inserted? • Is power switch set to match the recording medium? <ul style="list-style-type: none"> – When using DVD-RAM disc: Set to “”. If the LOCK switch on this DVD video camera/recorder is set to  (upper position), set it to  (lower position). If the LOCK switch is set to  (upper position), switching to “” is not possible. – When using SD memory card: Set to “”. • Is loaded DVD-RAM disc write-protected? • When using SD memory card: Is the erase prevention switch locked? (p. 27) • Does disc or card have remaining recording space? <p>If still cannot be recorded after the above check is clear, the disc or card may be damaged: Use another disc or card.</p>	

Check 3	Skip or search playback does not work well
<p>If the temperature inside the DVD video camera/recorder is high, normal operation may not be possible. Turn the DVD video camera/recorder off, wait for a few moments, and then turn it on again for operation.</p>	

Check 4	No operation can be performed because the ACCESS/PC or CARD ACCESS indicator on this DVD video camera/recorder remains lit or blinking.
<ul style="list-style-type: none"> • After disc or card is inserted, it takes some time until recording is possible. <p>In the following cases, it will take more time than usual until operation is possible:</p> <ul style="list-style-type: none"> • Immediately after a disc or card is reinserted. • When a long time has elapsed since the DVD video camera/recorder was turned off last. • When the temperature is greatly different from the status of previous recording. • When disc with scratches, dirt or fingerprints is inserted. • When disc is subject to severe vibrations. • When the battery or DC power cord was disconnected instead of following the correct procedure using power switch to turn the DVD video camera/recorder off. 	

Check 5	No DVD video camera/recorder operation
<p>Is a fully charged battery attached? Is the DVD video camera/recorder powered from AC outlet?</p>	

Check 6	No image in viewfinder
<p>Is LCD monitor open? No image will appear in viewfinder unless the LCD monitor is closed and securely locked to DVD video camera/recorder.</p>	

Check 7	No image appears on the LCD screen or in the viewfinder
<ul style="list-style-type: none"> • Is DVD video camera/recorder connected to PC using PC connection cable? (DZ-GX20A/DZ-MV780A) Unplug the PC connection cable. • Does DVD video camera/recorder stop at the end of the scene to which wipe-out was set and played back? Press the DISC NAVIGATION button. 	

Trouble Messages

A message may appear while you are operating the DVD video camera/recorder. If a message appears, refer to the following table and take appropriate corrective action. Messages are arranged in alphabetical order.

Message	Cause & Troubleshooting	Reference page
<p>(1) Data error in a part of image file. Repair data now?</p> <p>(2) Found error in image file. Repair data now?</p> <p>(3) Data error in all image file. Repair all data now?</p>	<p>It is possible that the system cannot normally complete writing of file when power is turned off for some reason during recording or editing (deleting, dividing or combining scenes, or creating play list). Selecting "YES" will automatically repair the video file, but even if "NO" is selected, the same message will appear when the DVD video camera/recorder is turned on next time. (Do not remove the disc while the DVD video camera/recorder is recognizing it: Ignoring this will deactivate the file repair function.) Follow the instructions on screen, taking note of the following cautions:</p> <ul style="list-style-type: none"> • Repair will normally be complete in several minutes, but it may take longer (up to one hour). • Be sure to use the AC adapter/charger to power the DVD video camera/recorder when repairing data: Repair is not possible using a battery. If a battery has been attached, turn the power switch off once, connect the AC adapter/charger, and then start repairing. • Data may not be repaired, depending on the timing when power was turned off. • Data may not be repaired normally if data recorded on another recorder is mixed in. • The repaired data may be different from the original recorded content because of partial deletion of defective portion. • Since the date/time for repair is added to the repaired data (only the corrected portion for partial repair), the original date/time information will be lost. • Since all movies, and then all stills, are repaired, the order of recorded contents will be lost in case of message (2) (3) only. • See *1 on page 166. 	—
<p>(1) Disc is not formatted. If it formats, it becomes possible to use for camera.</p> <p>(2) However, when you record from PC connection terminal, please do not format.</p> <p>(3) Format the disc now?</p>	DVD-R disc that was not initialized for camera use was inserted.	46
Battery is almost empty. Replace it.	Replace with a charged battery, or use AC adapter/charger to power the DVD video camera/recorder.	39, 43
Cannot combine scene.	Unless consecutive scenes are selected, they cannot be combined.	113

Message	Cause & Troubleshooting	Reference page
Cannot combine scene of multiple programs. Create Playlist first, and then combine scenes.	Scenes in different programs (different recording dates) cannot be combined. Create a Playlist first, and then combine such scenes on the playlist.	113
Cannot combine. Deselect PHOTO scenes.	Select only movies and combine them.	113
Cannot combine. Select multiple scenes.	Select a range of at least 2 scenes to be combined, and then combine them.	113
Cannot delete scenes.	This may occur when scene that was edited for division, etc. is to be deleted. Combine the divided scenes, and then delete them.	110, 113
Cannot execute. Change display category to ALL.	This message will appear if you attempt to combine or move scenes with "Category: VIDEO or PHOTO" specified.	136
Cannot execute. Unselect multiple scenes.	Division or change in thumbnail was executed when multiple scenes were selected.	106
Cannot read disc. Check dirt/crack/both-sides contrary/inserted correctly.	Error occurred while the disc was being recognized. Make sure that there is no scratch or dirt on disc, that the surface/back of disc is not reversed, and that the disc is firmly pushed against the turntable. See *3 on page 166 for troubleshooting.	7, 26, 45
CANNOT RECORD PHOTOS	Are you using DVD-R disc? You cannot record still image on DVD-R disc (recordable of still images from PC). Use DVD-RAM disc to record still images.	24
Cannot replace thumbnail on PHOTO scenes.	The thumbnail of a still cannot be changed. Select a movie.	116
Cannot select any more scenes.	The maximum number of selectable scenes is 999.	119
CARD ALMOST FULL	Remaining space is only enough to record less than 10 stills. Delete unnecessary stills and try the card, or use another card.	29, 110, 133
Card error has occurred. Format the card now?	Was the card formatted on PC? Was formatting interrupted midway? When using the card on this DVD video camera/recorder, choose "YES" and format it.	132
Card error has occurred. Formatting is not complete.	The card may be damaged: Use another card.	27
Card error.	<ul style="list-style-type: none"> The card terminals may be dirty: Wipe off dirt, and try the card again, or use another card. Data other than still image may be included: Use another card. 	27
Card error has occurred. Keep card inside & restart.	Card error could have occurred during editing of scenes. Turn off the DVD video camera/recorder with the card being used inside, connect the AC adapter/charger, and then power the DVD video camera/recorder again. Repair of scenes will be attempted.	43, 44

Message	Cause & Troubleshooting	Reference page
Card full.	Delete unnecessary stills and try the card, or use another card.	29, 110
	No more recording on this card can be done: Delete unnecessary stills or use another card.	
Card full. Cannot execute.	Delete unnecessary stills and try the card, or use another card.	29, 110
Card is not formatted. Format the card now?	Was the card formatted on PC? When using the card on this DVD video camera/recorder, choose "YES" and format it.	132
CHECK DISC	A disc unusable on this DVD video camera/recorder may have been inserted or the disc may be damaged. Make sure that the type of disc is correct, and make sure that the disc is not write-protected.	25, 133
Control Information Error.	Mismatch may occur between the recorded image and scene information. Update the control information.	134
	<ul style="list-style-type: none"> • Use another disc. • See *3 on page 166. 	24, 26
COPY PROTECTED	The video signal input to this DVD video camera/recorder may be copy-guarded. Some prerecorded video materials, such as movies, are guarded against copying. Copy-guarded materials cannot be recorded on this DVD video camera/recorder.	80
DISC ACCESS	The recorded scene is being stored on disc. Wait until the message disappears, and you can start to use the DVD video camera/recorder.	49, 51
	This DVD video camera/recorder is verifying whether the correct disc has been inserted. Wait until the message disappears, and you can start to use the DVD video camera/recorder.	158
DISC ALMOST FULL	Remaining free space on disc is less than 1 minute of video or 10 photos: Delete unnecessary scenes or use another disc.	28, 110
Disc error has occurred. Finalizing is not complete.	<ul style="list-style-type: none"> • Disc error occurred during finalizing, and finalizing failed. Replace the disc. • See *3 on page 166. 	135
Disc error has occurred. Format the disc now?	<ul style="list-style-type: none"> • Has the disc been initialized on PC? Has initializing the disc on PC been interrupted? Choose "YES" and initialize the disc when using it on this DVD video camera/recorder. Initializing the disc will erase all data on it. • See *2 on page 166. 	132
Disc error has occurred. Formatting is not complete.	The disc may be dirty. Remove the disc and wipe off fingerprints, dust, etc. before reusing it, or use another disc. This message may also appear if you insert a disc for which formatting was interrupted midway. In this case, use another disc.	26, 132
Disc error has occurred. Keep disc inside & restart.	Disc error could have occurred during editing of scenes. Turn off the DVD video camera/recorder with the disc being used in it, connect AC adapter/charger, and then power the DVD video camera/recorder again. Repair of scenes will be tried.	43

Message	Cause & Troubleshooting	Reference page
Disc error.	<ul style="list-style-type: none"> • Use another disc. • See *3 on page 166. 	24, 26
	<ul style="list-style-type: none"> • Mismatch in recording information may be caused by editing done on some device other than this DVD video camera/recorder. • Initialize the disc or use another disc. • Initializing the disc will erase all data on it. 	132
Disc full. Cannot execute.	Delete unnecessary scenes before using this disc, or use another disc.	110
Disc has no data.	This message will appear when an attempt is made to execute playback or editing on Disc Navigation with no scene recorded.	—
Disc has no Play List.	Switching of play list was selected with no play list stored.	125
Disc includes protected scenes. Delete scenes?	The disc may be software protected from a device other than this DVD video camera/recorder. To release this case, use a device that has executed software-protect.	—
Disc is full. Cannot add control info.	The number of entered scenes has reached the limit that can be entered, so the control information for generating thumbnails cannot be added. Combine several scenes or delete them.	110, 113
Disc is not formatted. Format the disc now?	<ul style="list-style-type: none"> • Has the disc been initialized on a PC? Choose "YES" and initialize the disc when using it on this DVD video camera/recorder. Initialization will delete all data on the disc. • See *2 on page 166. 	132
Drive overheat. Please retry later.	The temperature inside the DVD video camera/recorder is too high, and reading or writing of the data on disc may not be performed normally. Turn the DVD video camera/recorder off and wait for a while. The temperature will be effectively decreased if the DVD video camera/recorder is placed in a well-ventilated spot.	44
DVD-R Disc, 16:9 mode cannot be changed when Video mode is STD.	With DVD-R disc, the setting of 16:9 mode will not be possible when the Video mode is STD.	93
DVD-R Disc, Input Source cannot be changed.	Once a DVD-R disc has been recorded in the 16:9 mode, the input source will not be changeable.	93
DVD-R Disc, Video mode and 16:9 mode cannot be changed.	With DVD-R disc, the movie quality mode and 16:9 mode once used for recording cannot be changed.	28, 91, 93
END OF DISC	The disc is full. You cannot record on this disc anymore. Prepare another disc or delete unnecessary movie scenes from this disc.	28
End scene cannot be divided.	Division is not possible at the end of scene.	112
Error occurred. Please replace disc or format disc.	<ul style="list-style-type: none"> • Abnormality has occurred with the DVD-RAM disc to be repaired. Initialize the disc before using it, or use the another disc. Initializing the disc will erase all data on it. • See *2 on page 166. 	132

Message	Cause & Troubleshooting	Reference page
Error occurred. Please replace disc.	An abnormality occurred with a DVD-R disc to be repaired. Replace the disc.	—
Finalize may not be complete. Finalize again now?	Instantaneous shutoff occurred during finalizing, after which power was supplied and disc was inserted.	135
It is unrecordable on this card.	The inserted card cannot be used in this DVD video camera/recorder: Use another card.	27
JPEG file related to scenes are not found.	This message will appear when stills recorded on DVD-RAM disc using a device other than this DVD video camera/recorder are to be copied to card.	—
No card.	Insert a card.	48
No card. Please insert card.	No card is inserted. Insert a card.	48
NO DISC	This message may appear when the DVD video camera/recorder or disc is moved from a cold place to a warm place. Condensation has occurred on the camera/recorder lens or DVD-RAM drive. Do not remove the disc; leave the DVD video camera/recorder turned off in a place as dry as possible for 1 – 2 hours.	7
	The disc has not been inserted. Insert it.	45
	The disc is not inserted correctly. Push the disc against the turntable at the center until a click is heard. See *3 on page 166.	45
	Is the disc surface/bottom reversed? Check the surface/bottom of disc, and reinsert it correctly.	45, 46
No more scenes. Play List was deleted.	<ul style="list-style-type: none"> All scenes are deleted from the play list. Since a play list with no scenes cannot be supported by specifications, a play list from which all registered scenes have been deselected will be deleted. 	127, 128
Photo cannot be divided.	Still image cannot be divided.	112
PlayLists over limit.	An attempt was made to create new play list or copy play list, even though limit specified for play lists in the video recording standard had already been stored.	124
Same scenes on Play List will be deleted. Delete scenes?	<ul style="list-style-type: none"> This will appear when scenes are to be deleted. When a play list exists on disc, an attempt to delete scenes in program will display this message. (This message will not appear if you deselect scenes from play list.) 	110
Scenes over limit. Cannot add scene.	The number of scenes entered in play list has reached the limit that can be entered. Delete several scenes.	124, 128
Scenes over limit. Cannot divide scene.	The number of entered scenes has reached the limit that can be entered. Delete several scenes.	112, 124
Scenes over limit. Cannot move scene.	This message will appear if you try to move a scene when the number of scenes has already reached the registrable limit.	113, 124
Stop processing	The  button was pressed to stop processing of multiple scenes.	—

Message	Cause & Troubleshooting	Reference page
There was no scene which can be deleted.	This message will appear if you try to delete multiple scenes on Disc Navigation when all the selected scenes have been locked. Release the lock on scenes before executing deletion.	110, 118
This card cannot be used. Please replace card.	The card cannot be used in this DVD video camera/recorder: Use another card.	27
This disc cannot be used. Please replace disc.	A disc that cannot be used on this DVD video camera/recorder has been loaded. Check the type of disc.	25
This disc is recorded by the PAL system. Please replace disc.	This DVD video camera/recorder can use only discs recorded on the NTSC system. A disc recorded on the PAL system cannot be used on this DVD video camera/recorder.	—
Top scene cannot be divided.	Division is not possible at the start of scene.	112
UNFORMAT DISC	The disc is not initialized or it is damaged. If this message appears, be sure to initialize the disc on this DVD video camera/recorder before using it. Reinitializing even a disc used on this DVD video camera/recorder may be necessary (initializing will erase all recorded contents on disc). If this message appears, try to initialize the disc. If the same message still appears, the disc may be damaged: Use another disc.	132
	See *2 on page 166.	26
Use AC adapter/charger.	Finalization is not possible when the DVD video camera/recorder is powered by a battery: Use the AC adapter/charger for finalization.	43, 135
Use AC adapter/charger. Turn off power.	Scene cannot be repaired when the DVD video camera/recorder is powered by a battery. If the AC adapter/charger is unavailable in handy place, remove the disc, use the opposite side, or use another disc. To repair the removed disc, insert the disc into the DVD video camera/recorder afterwards, and connect the AC adapter/charger.	43
VIDEO scene cannot be copied to card.	No movie can be copied to card. Select stills and copy them to card.	117
Write protected. Check card.	A card with the erase prevention switch locked is inserted: Unlock the switch.	27
Write protected. Check disc.	<ul style="list-style-type: none"> • A write-protected disc is inserted. • Release the write-protect using the Disc Navigation menu. 	133

*1

- This message may also appear when dirt adheres to disc. If this message appears when a recorded disc is recognized immediately after it is inserted, do not repair the disc; remove it and then use a soft, dry cloth to clean off the dirt before using it.
- This message may also appear when condensation occurs. In this case, do not repair the disc; turn the DVD video camera/recorder off, wait until it dries out, and then turn it on again.
- If the repair message appears when you turn the DVD video camera/recorder on from off with a disc loaded after recording on it, choose repair.
- If the repair message appears when recording and playback are normally possible with another disc – and no condensation occurs and the disc is not dirty – choose repair.

*2

- This message may also appear when dirt adheres to disc. In this case, do not initialize the disc: Remove it and then use the provided disc cleaning cloth to clean off the dirt before using it.
- This message may also appear when condensation occurs. In this case, do not initialize the disc; turn the DVD video camera/recorder off, wait until it dries out, and then turn it on again.
- Initialization will delete all data on disc.

*3

- This message may also appear when dirt adheres to disc. Remove the disc and then use the provided disc cleaning cloth to clean off the dirt before using it.
- This message may also appear when condensation occurs. Wait until the DVD video camera/recorder dries out, and then turn it on again.
- This message will appear when a single-sided disc is inserted in reverse. Reinsert the disc correctly. (Insert the disc with the label printed surface facing the outside.)

Troubleshooting

Check to see the following before asking for a repair. If the suggested solution still cannot restore the DVD video camera/recorder to normal, do not attempt to repair it yourself, but consult your dealer.

Power supplies

Symptom	Cause and Correction	Reference page
Battery cannot be charged.	Is the ambient temperature too low or too high? Charge the battery at 50 – 86°F (10 – 30°C).	39
	Is the battery abnormally hot? Remove the battery, leave it for a while to cool down, then charge it.	
	Is the DC power cord connected to AC adapter/charger? Unplug it.	
	Has the battery been unused for a long time? Remove the battery, and then reattach it. If the battery is still not charged, it may be dead: Purchase a new one. • If the battery does not charge after you try the above four procedures, it may be dead: Purchase a new battery.	
Battery weakens fast	Are you using the DVD video camera/recorder where the temperature is low? A fully charged battery (DZ-BP14S/DZ-BP7S/DZ-BP14SW/DZ-BP7SW) may be discharged sooner than usual at low temperatures. Keep extra batteries on hand.	41
	Battery may be dead. The performance of battery will deteriorate if it is used for an extended period of time or frequently: Purchase a new battery.	42
The CHARGE indicator on AC adapter/charger is blinking.	Is the ambient temperature too low or too high? Charge the battery in environment where the temperature is 50 – 86°F (10 – 30°C). The battery has possibly discharged excessively. Continue charging: After a while, the battery will be charged to the specified voltage, and the CHARGE indicator will light. Then the battery charge will be completed normally.	39
Power turns off immediately after being turned on.	Is battery charged? Charge it.	39
When power is turned on, the LCD screen will turn on and off.		
Power goes off unexpectedly.	Is Power Save set to “On”? If the powered DVD video camera/recorder is left for as long as 5 minutes without recording or playback with “Power Save: On” specified, it will automatically turn off to save battery power. To restart recording in this case, set the power switch to “OFF” and then set it to “  ”. You can also specify “Power Save: Off” to stop automatic power off.	100
Power cannot be turned off.	Detach the battery or AC adapter/charger once, and then press the RESET button of DVD video camera/recorder: Reattach a power supply to DVD video camera/recorder before turning it on again.	40, 43, 174

Symptom	Cause and Correction	Reference page
Even if the DVD video camera/recorder is off, opening the cover will cause the ACCESS indicator to blink.	The DVD video camera/recorder will automatically turn on to recognize a disc: Closing the cover will automatically turn the DVD video camera/recorder off.	46

During recording

Symptom	Cause and Correction	Reference page
Pressing the REC or PHOTO button will not start recording.	Is input image copy-guarded? Is the disc write-protected or the card locked?	27, 81, 133, 158
Recording starts but stops immediately.	Is disc scratched or does dirt or fingerprint adhere to it? Clean the disc. If there is still no improvement, replace the disc.	51
	Is some other AV device directly connected to the video/audio input/output jack of this DVD video camera/recorder? If the AV device is connected via several other devices, such as AV selector, the video signal may not be transmitted incorrectly. In such a case, reduce the number of devices through which the video signal is transmitted, or connect AV device directly.	80
	Are you attempting to record image from video game or PC? From some video games or PCs, image cannot be recorded on this DVD video camera/recorder.	80
LCD screen is hard to see.	Has brightness of LCD screen been adjusted? Stop recording and adjust the brightness.	98
	Is the DVD video camera/recorder being used outdoors? Use the viewfinder. When using LCD monitor, adjust its angle so that LCD screen is not exposed to direct sunlight.	35, 36
Focus is not correct.	Is it difficult to use auto focus with your subject? Focus manually.	73
	Does "MF" appear? The DVD video camera/recorder is set to manual focus. Focus the subject manually, or release manual focus.	72
	Is the diopter control correctly adjusted if you are using the viewfinder as a monitor? Adjust the diopter control.	36
	In cases other than the above, set the power switch to "OFF", and then set it to "📷", "📹" or "📺" again.	44
An error message for repair appears.	Repair is only possible when the DVD video camera/recorder is powered by the AC adapter/charger. Remove the disc, and then insert another disc: The removed disc can later be repaired by connecting the AC adapter/charger.	43
Unevenness appears on LCD monitor screen.	Did you press the LCD monitor or the area around it? If the LCD monitor is pressed, some unevenness will occur. Release your hand and leave the LCD monitor for a while: Normal display will be restored.	—

During playback

Symptom	Cause and Correction	Reference page
Recognition of disc is not complete	Is disc dirty? Use the provided disc cleaning cloth to clean it.	51
Pressing the playback button will not start playback.	Has the image been recorded by devices other than this DVD video camera/recorder? Playback of image recorded on devices other than this DVD video camera/recorder may be impossible on this DVD video camera/recorder.	58
	Has scene been edited on a device other than this DVD video camera/recorder? If a scene recorded on this DVD video camera/recorder is edited on a device other than this DVD video camera/recorder, playback may not be possible on this DVD video camera/recorder.	
No playback picture appears on TV screen.	Is TV input selector set correctly? Some TVs have multiple video input jacks. Check whether the correct input was selected on TV to match the connected jacks. If the DVD video camera/recorder is connected to VCR, set its input selector to "external input (LINE)".	78
	Is the DVD video camera/recorder connected to TV correctly? Check the connections.	77
Playback picture is momentarily interrupted.	Is disc scratched or does dirt or fingerprint adhere to it? Clean the disc.	26
Poor playback picture	Was the image input from analog VCR (VHS, 8 mm) and recorded? The problem may be improved if a VCR equipped with TBC circuit is used for playback.	—
Playback picture is greatly distorted.	Was recording of external input made with "Frame" specified? Specify "Field" for "PHOTO Input" in record functions setup.	95
No sound	Is the TV volume control set correctly? Adjust TV volume control, and be sure to adjust the volume on TV.	78
Disc Navigation thumbnails do not appear.	Was the image recorded from AV input/output jack with interference? Record image with no noise or disturbance.	—

Symptom	Cause and Correction	Reference page
<p>Photos on card cannot be played back.</p>	<p>This DVD video camera/recorder can play back image data recorded on SD memory card in other digital cameras conforming to the DCF (Design rule for Camera File system) standard. The range of image data normally playable on this DVD video camera/recorder is that with pixels from 80 horizontal × 60 vertical to 4000 horizontal × 3000 vertical. If the pixel data is outside this range, blue thumbnails will appear (thumbnails* in the figure), meaning the image is unplayable.</p> <div data-bbox="439 347 636 497" data-label="Image"> </div> <p style="text-align: center;">* Fig. 1</p> <p>Even when the number of pixels is within the above range, playback may not be possible, depending on the recording status of the digital cameras used. DCF (Design rule for Camera File system) is an integrated image file format of digital cameras: Image files can be used on all digital devices conforming to DCF.</p>	—
<p>It will take some time to play back photos on card.</p>	<p>When playing back a still, “Playback.” will appear: Stills with a large number of pixels will take some time to appear.</p>	—

When the DVD video camera/recorder is connected to PC:

Symptom	Cause and Correction	Reference page
No drive icon appears on PC.	The DVD video camera/recorder is not turned on. Check the power supply.	44
	Turn PC off and then disconnect the PC connection cable. Turn PC on again, and then use the PC connection cable to connect the DVD video camera/recorder to PC.	—
	Make sure the PC connection cable is completely plugged into this DVD video camera/recorder.	—
Error occurs in playback of DVD video camera/recorder on PC.	If error occurs with USB connection, the transfer rate is not sufficient. It is recommended that you use a USB terminal conforming to USB2.0 when connecting the DVD video camera/recorder.	141
Application is not normally run on PC.	Turn the PC and DVD video camera/recorder off, and try again.	—
Error occurs during writing to disc.	The temperature of DVD video camera/recorder is too high due to continuous operation. Disconnect the DVD video camera/recorder from PC once, remove the disc from the DVD video camera/recorder, and then turn it off. After a few moments, connect them again and write to a brand-new disc.	—
Transfer of images stops.	Connect the DVD video camera/recorder to another USB terminal of PC. If your PC is a desktop type, it is recommended that you use USB terminal on the back of PC. If you are using USB2.0 extended card, it is also recommended that you install the newest version driver provided by each USB2.0 card maker.	—
DVD-RAM/R drive built into PC cannot be used after the provided software has been installed.	This problem may be solved if the software related to DVD-RAM/R/RW of your PC is upgraded, or if the UDF driver is uninstalled. However, with Windows® Me / 2000 Professional, uninstalling the UDF driver will make it impossible for the JPEG stills recorded on DVD-RAM of this DVD video camera/recorder to be read by the PC.	—
DVD-R disc cannot be played back on DVD-MovieAlbumSE.	DVD-MovieAlbumSE does not support playback or data read on DVD-R disc: Use generally available DVD video playback software to play back DVD-R disc on PC.	143
Error appears when starting DVD-MovieAlbumSE.	Make sure that your PC display adapter (video card) conforms to DirectX8.1.	141
Video written to hard disk of PC cannot be edited on DVD-MovieAlbum copy tool.	DVD-MovieAlbumSE cannot edit DVD-VR data stored on hard disk of PC: Copy the data to another DVD-RAM disc and then edit it.	—
Movies are not recognized by application in PC.	Make sure the power switch of this DVD video camera/recorder is set to "⏻" or "⏺".	—

Symptom	Cause and Correction	Reference page
The DISC EJECT button is not valid when the DVD video camera/recorder is connected to PC.	While the DVD video camera/recorder is connected to PC, use Explorer to right-click the DVD video camera/recorder drive icon and execute "Eject". If DVD-MovieAlbumSE is running, clicking the eject button on DVD-MovieAlbumSE will open the cover of disc insertion block of this DVD video camera/recorder: Remove the disc.	—
When the time stamp of file in DVD-RAM is viewed on PC, it is different from the actual recording time.	The file system of this DVD video camera/recorder is operated on Greenwich Mean Time (GMT), and time lag information has not been set. With Windows® as of January, 2005, the time stamp of file viewed on Explorer looks different from the actual recording time. The actual recording time will appear for date/time indication on playback screen.	—
When DVD-MovieAlbumSE is started, "Disc in Drive X: cannot be used" appears.	A disc other than DVD-RAM is loaded in drive: DVD-MovieAlbumSE cannot be used for media other than DVD-RAM. Click the "Preference" button in the dialog box, click the "Device Setting" tab to choose the drive where DVD-RAM disc is loaded in the "Drive Select" column, and then click "OK".	—
An image that should have been recorded does not appear when DVD-MovieAlbumSE is started.	Click the "Preference" button at top right of DVD-MovieAlbumSE screen, click the "Device Setting" tab to choose the drive where DVD-RAM disc is loaded in the "Drive Select" column, and then click "OK".	—
No USB HS (high speed) connection even when USB2.0 card is used.	Make sure that you have already installed the driver provided with the USB2.0 card. You will need to install the driver provided by USB2.0 card maker in order to operate the USB2.0 card at HS (high speed).	147
Executing "Export" on DVD-MovieAlbumSE will interrupt reading midway.	Do not choose "Simple Export": If you do, reading will stop midway.	—
When executing "Export" on DVD-MovieAlbumSE, it will take time to read.	<ul style="list-style-type: none"> If stills are included in the range of "export", it may take more time because data must be re-encoded and read. If "Divide by Chapter" is not chosen, it may take some time because data will be read while being re-encoded. 	147
"Hardware Removal" results in error.	Exit Windows® once, and then disconnect the DVD video camera/recorder. If your PC uses Windows® 2000 Professional, the problem may be solved if you install Windows® 2000 Service Pack 3 or later.	—

Miscellaneous

Symptom	Cause and Correction	Reference page
Power does not come on, or no operation occurs by pressing button.	Execute system reset (press the RESET button).	174
	Has the DVD video camera/recorder been subjected to impact? The DVD video camera/recorder could be damaged. Consult your dealer.	—
The date and time are incorrect.	Has the DVD video camera/recorder been left unused for a long period of time? The internal backup memory battery may be discharged: Charge it.	37
No scene can be deleted.	Is the cursor placed on the scene to be deleted? If the selected scene (framed in red) exists, that scene will be deleted even if you use yellow cursor to select any scene. Check the colors of cursors and bar graph on the thumbnail screen.	104
Disc cannot be removed. (Cover will not open.)	Did you detach the battery or AC adapter/charger before setting the power switch to "OFF"? Is the battery charged? Connect a charged battery or the AC adapter/charger, and then press the DISC EJECT button to remove the disc. Did the DVD video camera/recorder turn off because the battery remaining level ran out? Connect a charged battery or the AC adapter/charger, set the power switch to "OFF", and then press the DISC EJECT button to remove the disc.	43, 44
DVD video camera/recorder cannot be operated from remote control.	Is the remote control pointed at the infrared receiver on DVD video camera/recorder? Point it at the infrared receiver to operate the DVD video camera/recorder.	34
	Is the infrared receiver on DVD video camera/recorder exposed to direct sunlight or strong fluorescent light, etc.? The remote control cannot operate the DVD video camera/recorder when strong light strikes the infrared receiver. Adjust the place or angle of the DVD video camera/recorder.	34
	Is there battery in the remote control? Also check the polarities of battery. The battery could be dead: Try replacing it.	33
	Is the DVD video camera/recorder powered? Turn it on.	44
Disc cover cannot be closed.	Is disc correctly inserted? Was disc inserted from wrong direction? Remove the disc and then reinsert it.	45
	Connect a fully charged battery or AC adapter/charger, and then turn the DVD video camera/recorder on.	39, 43
Operating sound is heard cyclically.	This sound is heard because the disc is cyclically operated and does not indicate a fault.	—
Some vibrations are felt or slight sound is heard from mechanism.	These vibrations or sound are caused by disc drive: This does not indicate a fault.	—

System Reset

If the DVD video camera/recorder does not operate normally, perform "System Reset": The DVD video camera/recorder may recover to normal. "System Reset" will reset all settings to factory defaults. The date and time will also be reset: Set the date and time again before using the DVD video camera/recorder.

- 1 Set the power switch to "OFF" to turn the DVD video camera/reorder off.

Note:
Do not press the reset button with undue force.

Detach the battery or AC adapter/charger.

- 2 Use a fine tipped pen to hold down the reset button for several seconds.

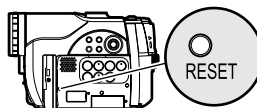

All settings will be reset.

● List of setting items

	Item	Default	Setting method
Camera Functions Setup	Program AE	Auto	p. 86
	White Bal.	Auto	p. 88
	EIS	On	p. 90
	Dig.Zoom	40x	p. 56
	MIC.Filter	Off	p. 90
Record Functions Setup	VIDEO Mode	FINE	p. 91
	Quality	FINE	p. 94
	16:9	Off	p. 92
	Input Source	CAMERA	p. 94
	PHOTO Input	Field	p. 95
	Self Timer	Off	p. 96
	OSD Output	On	p. 97
Date Setup	Date Set	1/1/2005 12:00AM	p. 37
	Date Mode	M/D/Y	p. 38
LCD/EVF Setup	LCD Brightness		p. 98
	EVF Brightness		p. 98
	Color Level		p. 99
	EVF Display	Auto	p. 99
Initial Setup	Beep	On	p. 100
	Power Save	Off	p. 100
	Record LED	On	p. 101
	Language	English	p. 101
	Demo Mode	Auto	p. 154

* Some items will not appear depending on the disc or card inserted.

Major Specifications

<p>CCD</p>	<p>DZ-GX20A : 1/3.6-inch interlaced DZ-MV780A : 1/4.5-inch interlaced DZ-MV730A : 1/6-inch interlaced</p> <p>Total number of pixels</p> <p>DZ-GX20A approx. 2,120,000 DZ-MV780A approx. 1,330,000 DZ-MV730A approx. 680,000</p> <p>Number of effective pixels</p> <p>DZ-GX20A Movie: approx. 1,230,000 Still: approx. 1,920,000</p> <p>DZ-MV780A Movie: approx. 690,000 Still: approx. 1,100,000</p> <p>DZ-MV730A Movie: approx. 340,000 Still: approx. 340,000</p>
<p>Lens</p>	<p>DZ-GX20A : F1.8 – 2.2 f = 3/16" – 1-3/4" (4.5 – 45 mm) Filter diameter: 1-5/16" (34 mm) Thread pitch: 0.5 mm</p> <p>DZ-MV780A : F1.8 – 2.3 f = 1/8" – 1-1/4" (3.2 – 32 mm) Filter diameter: 1-1/4" (30.5 mm) Thread pitch: 0.5 mm</p> <p>DZ-MV730A : F1.6 – 2.3, f = 1/8" – 1-1/16" (2.78 – 43.3 mm) Filter diameter: 1-5/16" (34 mm) Thread pitch: 0.5 mm</p>
<p>Focus</p>	<p>Auto/Manual</p>
<p>Zoom</p>	<p>Optical 10× (DZ-GX20A/DZ-MV780A), Optical 16× (DZ-MV730A), 240× with digital zoom added, 40× for still</p>
<p>Required minimum illumination</p>	<p>0.3 lx in Low Light mode</p>
<p>Viewfinder</p>	<p>0.2-inch color (equivalent to approx. 200,000 pixels)</p>
<p>LCD monitor</p>	<p>2.5-inch color TFT (approx. 120,000 pixels)</p>
<p>Electronic image stabilizer</p>	<p>Electronic type</p>
<p>Shutter speed</p>	<p>1/4 – 1/4000 second (movie)</p>
<p>Self-timer recording</p>	<p>Still recording only</p>
<p>External microphone jack</p>	<p>ø3.5 mm stereo mini-jack: (a plug-in power type microphone cannot be used)</p>
<p>Recording mode</p>	<p>Movie (with sound) Still (with DVD-RAM disc, SD memory card)</p>

Maximum recordable time (per side)	DVD-RAM disc DVD-R disc	approx. 18 minutes (XTRA) approx. 30 minutes (FINE) approx. 60 minutes (STD)
Maximum number of recordable stills	DVD-RAM disc (per side)	DZ-GX20A approx. 750 DZ-MV780A/DZ-MV730A approx. 999 If movies and stills are mixed on one disc, the recordable number will decrease.
	SD memory card (when using 32 MB card)	DZ-GX20A approx. 29 (in FINE mode) DZ-MV780A approx. 58 (in FINE mode) DZ-MV730A approx. 232 (in FINE mode) Varies depending on the recording quality and the type of card. (p. 29)
Recording format	DVD-RAM disc	Movie: Conforming to DVD video recording (DVD-VR) format (Dolby Digital) Still: Simultaneous recording, conforming to DVD video recording (DVD-VR) standard (704 × 480 pixels) and JPEG (DZ-GX20A: 1600 × 1200 pixels, DZ-MV780A: 1280 × 960 pixels, DZ-MV730A: 640 × 480 pixels) External input: 640 × 480 pixels
	DVD-R disc	Movie: Conforming to DVD video format (Dolby Digital)
	Card	Still: Conforming to JPEG (DZ-GX20A: 1600 × 1200 pixels, DZ-MV780A: 1280 × 960 pixels, DZ-MV730A: 640 × 480 pixels) standard External input: 640 × 480 pixels
Audio playback format	MPEG Audio layer 2, linear PCM, Dolby Digital	
Recording medium	8 cm DVD-RAM disc (conforming to DVD-RAM Ver. 2.1) 8 cm DVD-R disc (conforming to DVD-R for General Ver. 2.0) SD memory card	
Jacks	Video/audio input/output ×1, External microphone input ×1, PC connection terminal (connected to PC USB port) ×1 (not provided with DZ-MV730A)	
Battery system	Lithium-ion	
Power consumption	When recording with LCD monitor off (DVD-RAM disc used) DZ-GX20A approx. 4.4W (in FINE mode) DZ-MV780A approx. 3.8W (in FINE mode) DZ-MV730A approx. 3.2W (in FINE mode)	
Dimensions (W × H × D)	DZ-GX20A : approx. 2" × 3-9/16" × 5-3/8" (51 × 90 × 137 mm) (excluding projections) DZ-MV780A : approx. 2" × 3-3/8" × 4-13/16" (51 × 86 × 123 mm) (excluding projections) DZ-MV730A : approx. 2" × 3-1/2" × 5-1/4" (51 × 89 × 133 mm) (excluding projections)	

Operating temperature (humidity)	32 – 104 °F (0 – 40 °C) (less than 80%). 32 – 86 °F (0 – 30 °C) when connected to PC
Storage temperature	-4 – 140 °F (-20 – 60 °C)
Weight	DZ-GX20A approx. 480 g (without battery or disc) DZ-MV780A approx. 420 g (without battery or disc) DZ-MV730A approx. 450 g (without battery or disc)
Total weight when recording	DZ-GX20A approx. 555 g DZ-MV780A approx. 475 g DZ-MV730A approx. 505 g
Provided accessories	AC adapter/charger, Battery, AV/S input/output cable, Infrared remote control (not provided with DZ-MV730A), Lithium battery for remote control (not provided with DZ-MV730A), Lens cap, Lens cap string, Shoulder strap, Power cable, DC power cord, Software CD-ROM (not provided with DZ-MV730A), PC connection cable (not provided with DZ-MV730A), Single-sided 8 cm DVD-R disc (not provided with DZ-MV730A), Disc cleaning cloth

Index

Numerics

16:9	92
240x (Dig. Zoom)	56
40x (Dig. Zoom)	56
8 cm bare disc	24

A

AC adapter/charger	43
ACCESS/PC indicator	49, 51
Add (edit)	127
All programs	121
Auto (program AE)	86
Auto-focus	72
AV input/output jack	77

B

Backlight correction	74
Battery	39
Attaching to DVD video camera/recorder	40
Charging	39
Recordable time on DVD video camera/ recorder	41
Removing from DVD video camera/ recorder	40
Setting Up	39
BATTERY EJECT button	40
Beep	100
Black & White fade	114
Brightness	98

C

Camera Functions Setup	86
Capacity	133
Card	
Available	27
Capacity	29, 133
Category	136
Format	132
Handling	27
Quality	94
CHARGE indicator	39
Cleaning	153
Color Level	99
Connecting to TV	77
Copy	117
Create	124

D

Date and time	37
Date setup	37
Defaults	102
Delete (edit)	128
Delete (play list)	130
Delete (scene)	110, 127
Demo Mode	154
Detail (scene)	120
Dig. Zoom	56
Dioptr control	36
Disc	24
Available	24

Capacity	28
Finalize Disc	135
Format	132
Handling	26
Protect	133
Update Control Info.	134
DISC EJECT button	47
Disc guide	45
Display	52
Information LCD	52
Scenes information	120
Viewfinder	36
Divide	112
DVD player	79, 155
DVD-R	24
DVD-RAM	24
DVD recorder	79, 155
DVD video format	155
DVD video recording (DVD-VR) format	30, 155

E

Edit (play List)	127
EIS	90
EXPOSURE button	74
Exposure control	74
External microphone jack	75

F

Fade	114
FIELD (PHOTO Input)	95
Finalize Disc	135
FINE (VIDEO Mode)	91
FOCUS button	72
Format Disc	132
FRAME (PHOTO Input)	95
Frame advance/Frame back	59

G

Go To (during playback)	61
Go To (on Disc Navigation)	131

H

Hand strap	31
Howling	77, 156

I

Information display mode	52
Infrared receiver	34
Infrared sensor	156
Initial Setup	100
Input Source	94

L

Language	101
Laser pickup block	156
Lens cap	32
Lens cap string attachment hole	16
Linear PCM	35, 79, 156
Lock	118
Lock switch	17

Low Light (Program AE)	86
------------------------------	----

M

MF	72
MIC.Filter	90
Move	129

N

Normal Menu	84
-------------------	----

O

Optical 10x zoom lens	16
Optical 16x zoom lens	56
OSD Output	97

P

PHOTO Input	95
Play (play list)	125
Play (program)	122
Play list	124
Add scenes	126
Add scenes (submenu)	127
Create	124
Delete	130
Delete scenes	127
Delete scenes (submenu)	128
Move	129
Play	125
Select scenes (submenu)	128
Switch	125
Title	130
Portrait (Program AE)	86
Power Save	100
Power switch	44
Program	121
Play	122
Switch	121
Title	122
Program AE	86
Protect Disc	133

Q

Quality (Card)	94
Quick Menu	63
QUICK MENU button	64

R

Record button	49
Recording indicator	101
Remote control	33
Repeat Play	136
Reset	102
settings	102
system	174
RESET button	174

S

Sand & Snow (Program AE)	86
Scene	
Combine	113
Delete	110
Detail	120
Divide	112
Fade	114

Move	129
Select	119
Skip	115
Searching for image	59
Select (Scene)	106
SELECT button	106
Self Timer	96
Shoulder Strap	32
Skip (Scene)	115
Skip playback	60
Slide Show	137
Sports (Program AE)	86
Spotlight (Program AE)	86
STD (VIDEO Mode)	91
Stereo microphone	50
Submenu	111
Switch (play list)	125
Switch (program)	121

T

Tele-conversion lens	57
Thumbnail	104
Title (play list)	130
Title (program)	122

U

UDF2.01 format	149, 157
Update Control Info.	134

V

Video flash	76
VIDEO Mode	91
FINE	91
STD	91
XTRA	91
Video selector	81, 93, 157
Vol. button	58

W

White Bal.	88
White fade	114
Wide conversion lens	57
Wipe fade	114

X

XTRA (VIDEO Mode)	91
-------------------------	----

Z

Zoom lever	56
------------------	----

Be sure to read the following before opening the package of CD-ROM

This Agreement will take effect at the moment you open the package of the storage device (CD-ROM) provided with this product, if you agree to the terms herein.

If you do not accept the terms of this Agreement, immediately return the unopened package of storage medium and enclosed materials (printed matter, external package, and all others) to your dealer, or return only the package of storage medium to your dealer.

Consult your dealer for any refund on the unused product. However, if only the package of storage medium is returned, no refund is possible.

This License Agreement certifies that you were granted license in the past.

License Agreement

Article 1 Grant of License

Hitachi, Ltd. grants you the following rights for the following products (to be referred to as "This Software" hereafter) that you have obtained with this Agreement:

- (a) You may use This Software only on a single piece of equipment. However, if this equipment cannot be used because of mechanical problem, you may temporarily use This Software on another piece of equipment.
- (b) Although This Software contains several components that can be run on computer as independent functions, all components are licensed as a single product: You may not, by any means, use these components on different computers at the same time.

Article 2 Copyrights

The copyrights of This Software, attached manual, etc. are owned by Matsushita Electric Industrial Co., Ltd., and are protected by copyright laws in Japan and USA, as well as by other intellectual property and international properties:

Article 3 Other Rights and Limitations

- (a) You may not copy This Software or any of the printed materials attached, except for duplications to provide back-up or storage.
- (b) Use of This Software by third parties is prohibited, whether by transferring, renting, leasing, lending, moving, or any other measures.
- (c) You may not decompile or disassemble this Software.
- (d) Duplication and/or distribution of any files on this storage medium for commercial use is prohibited.

Article 4 Quality Assurance

Under no circumstances will Hitachi, Ltd., Matsushita Electric Industrial Co., Ltd. accept any responsibility for any damages you may incur from using or being unable to use This Software (including, but not limited to, loss of business profit, interruption of business, loss of business information, or other monetary damages).

Article 5 Termination of Agreement

If you fail to comply with the terms of this Agreement, Hitachi, Ltd., Matsushita Electric Industrial Co., Ltd. reserve the right to terminate the Agreement. In such a case, you will be obliged to discard all copies of This Software and its components.

Article 6 Prioritized License Agreement

When some software programs are installed, the license agreements will be displayed (to be referred to as online license agreement).

If the online license agreement conflicts with this Agreement, the online license agreement shall have a priority.