

HITACHI
Inspire the Next

PROGRAMMABLE CONTROLLER

EH-150



A Compact Body Packed with Next-Generation Capabilities. This is What the Control Systems of Tomorrow Really Need.

Control systems are increasingly being introduced in diverse fields.

At the same time, automatic machines have rapidly become more sophisticated.

The programmable controller that forms the heart of a control system, no matter how small the system may be, is strongly demanded to allow for advanced, complicated control, shorter program development periods, and easier maintenance.

The EH-150 incorporates the most advanced technologies in its compact body, such as a 32-bit RISC chip microcomputer for high-speed arithmetic operations, various application commands, and Flash memory. With its high performance and high functions, the EH-150 positively meets the new needs of the small and medium-sized control systems of tomorrow.

Program Memory
48k steps

NEW CPU EH-CPU548/516

Expansion : EH-CPU548 maximum 4, EH-CPU516 maximum 2

Slot for communication module : maximum 0 to 7
(in use of new base EH-BS5A/EH-BS8A/EH-BS11A)

New timer TM (maximum 2,048 points)



C-Tick compliant model is also available.

Point 1

Two communication ports are provided as standard in the small-sized CPU.

EH-150's CPU has two communication ports: Port 1 and Port 2. Port 1 can be used as a dedicated port and can be switched to a general-purpose port.

It also supports the modem control function (except for EH-CPU104A).

Port 2 can be used as a dedicated port for programming devices. When a general-purpose port is designated, the TRNS command can be used, making operation easier and improving connectivity.

The interface can be selected from RS-232C, RS-422, and RS-485 for port 1 general-purpose port and the port 1 dedicated port (EH-CPU316A and EH-CPU516/548).

① When Port 1 is used as a dedicated port

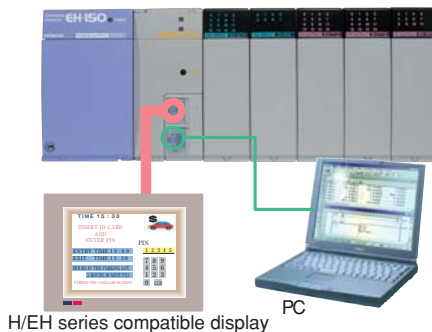

Multi-link connection of displays (EH-CPU316A and EH-CPU516/548)

Port 1 can be switched among RS-232C, RS-422, and RS-485. Task code communication with a station number by HI-PROTOCOL can be supported by using RS-422.

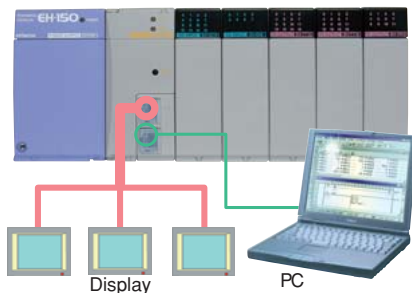

② When Port 1 is used as a general-purpose port

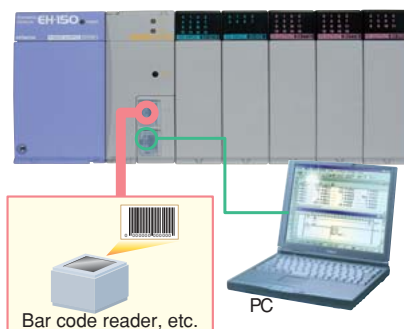

Point 2

A memory board that can read and write programs can be loaded in the CPU. (EH-CPU316A, and EH-CPU516/548)

Transferring and comparing programs can be done without a programming device.

The CPU can be operated with the program on the memory board.

A memory board that can store data (384k words) in addition to the program is also available (EH-MEMD).

The memory board employs a battery-less Flash memory to make maintenance easier.



Memory board
Model : EH-MEMP
EH-MEMD

Point 3

The compact and stylish EH-150 meets various automation requirements.

As many as 3520 I/O points can be configured on the EH-150, which is only 462.5 mm (W) × 100 mm (H) × 109 mm (D) in size.

The EH-150's compact size helps reduce machine size and save installation space, and its bright color and sleek design adds aesthetic appeal to the entire system.

Point 4

The modem connection capability incorporated as a standard feature allows for 38.4 kbps high-speed communication (EH-CPU208A, EH-CPU316A, and EH-CPU516/548).

Port 1 of EH-150's CPU(except for EH-CPU104A)has a modem connection function that supports 38.4 kbps high-speed communication.

The control operation can be remotely monitored through the public telephone line.

The clock function also incorporated as a standard feature realizes real-time control without an additional module.

LADDER EDITOR for Windows® Ver. 2.0 latter has the dial-up function. It is possible to connect to the public telephone line using the software.

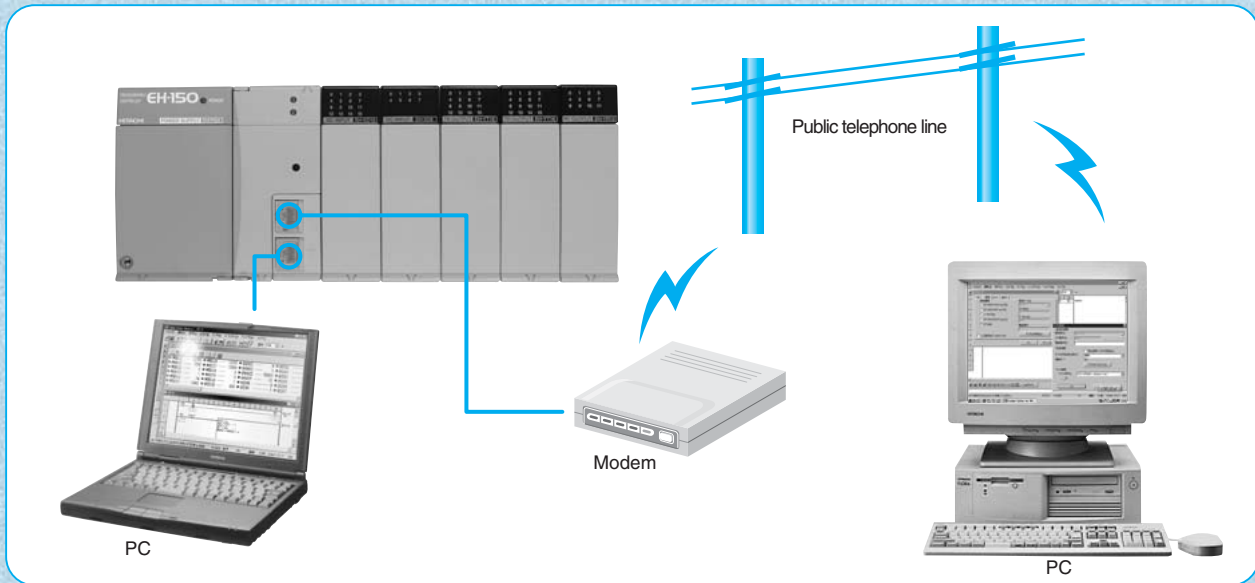

Point 5

The state-of-art technologies and functions realize high-speed processing of complicated control.

- The EH-150 contains a 32-bit RISC processor (Super H series made by Hitachi, Ltd.) that allows high-speed operations.
- To protect valuable programs from being erased, the EH-150 has a Flash memory for storing user programs.
- As many as 193 commands (EH-CPU516/548) are available. Commands such as REFRESH assure quick response to high-speed operation of assembly machines.

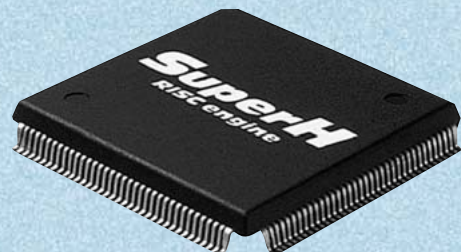

Compatibility with H series PLC utilizes valuable existing user programs.

- The same programming software 'LADDER EDITOR' can be used.
- LADDER EDITOR for Windows® provides easier programming and debugging with its comfortable operation environment.
- Various types of displays and monitoring software compatible with the H series PLC can be used as peripheral equipment.

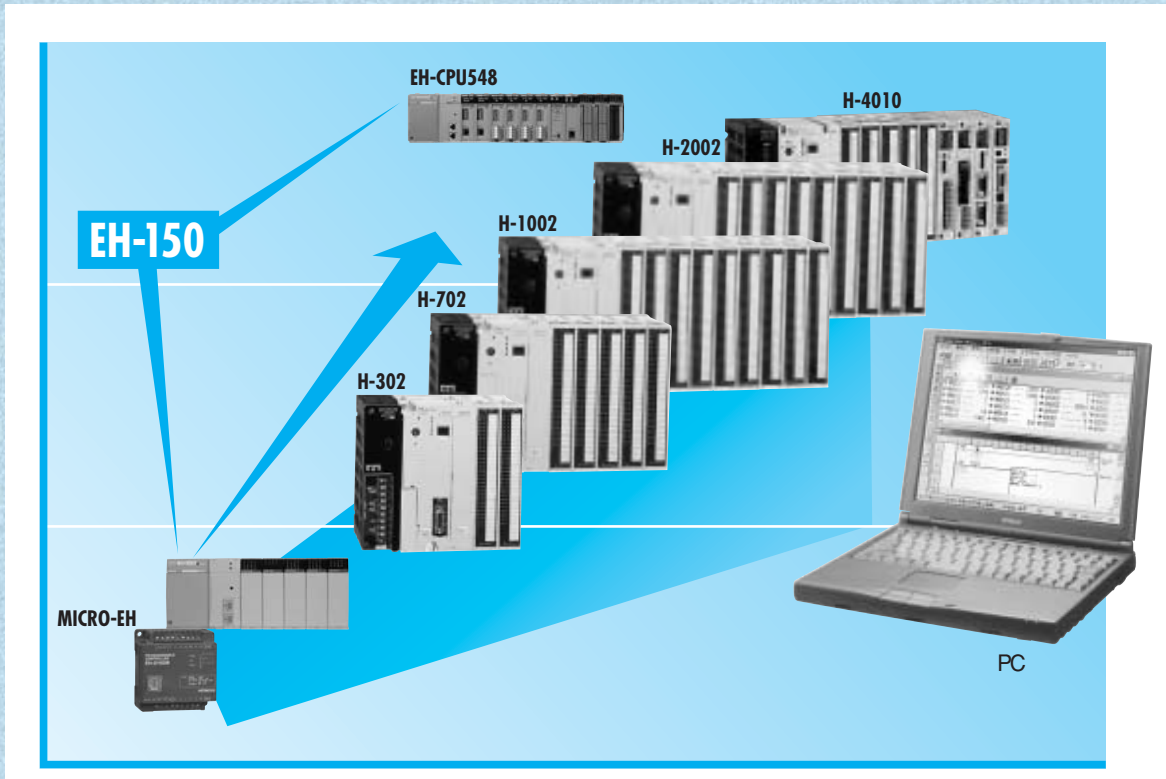

The maintenance fo EH-150 is easy even after installed in a machine.

- Flash memory protects user programs even if the power fails.
- Programs can be easily modified even while the CPU is running. This helps reduce the time required for a test run.
- Easy installation by snapping on a DIN rail
- Removable terminal block for easy set-up
- The battery for data memory back-up can be replaced by opening the hinged front cover of the CPU.



System Composition

Power supply module	
Model	Specification
EH-PSA	Input: 100 to 240 V AC Output: 5 V DC 3.8 A, 24 V DC 0.4 A
EH-PSD	Input: 21.6 to 26.4 V DC Output: 5 V DC 3.8 A

Memory board	
Model	Specification
EH-MEMP	Program capacity: 48k steps
EH-MEMD	Program capacity: 16k steps Data capacity: 384k words

CPU module	
Model	Specification
EH-CPU104A	4k steps 2 ports (19.2 kbps) (Cannot be expanded)
EH-CPU208A	8k steps, 2 ports (38.4kbps), Clock function, Modem control function
EH-CPU316A	16k steps, 2 ports (38.4 kbps), Clock function, Modem control function, RS- 422/RS-485 dedicated/general port, PID
EH-CPU516	16k steps, 2 ports (38.4 kbps), Clock function, Modem control function, RS- 422/RS-485 dedicated/general port, PID
EH-CPU548	48k steps, 2 ports (38.4 kbps), Clock function, Modem control function, RS- 422/RS-485 dedicated/general port, PID

Analog input module			
Model	Specification	Model	Specification
EH-AX44	12-bit analog input Current 4-20 mA, Voltage 0-10 V, 4ch each Removable terminal block	EH-AX8IO	12-bit analog input Current 0 - 22 mA, 8ch Removable terminal block
EH-AX8V	12-bit analog input Voltage 0-10 V, 8ch Removable terminal block	EH-PT4	Resistance Temperature Detective input module (Pt100/1000), Signed 15 bit, 4ch
EH-AX8H	12-bit analog input Voltage -10 to 10 V, 8ch Removable terminal block	EH-TC8	Thermocouple input module (K, E, J, T, B, R, S, N)
EH-AX8I	12-bit analog input Current 4 - 20 mA, 8ch Removable terminal block	EH-AXH8M	14-bit analog input Current 0 - 22 mA, 4 - 20mA Voltage -10-10V, 0-10V, 8ch Removable terminal block

Analog output module	
Model	Specification
EH-AY22	12-bit analog output, Current 4-20 mA, Voltage, 0-10 V, 2ch each Removable terminal block
EH-AY4V	12-bit analog output, Voltage 0-10 V, 4ch Removable terminal block
EH-AY4H	12-bit analog output, Voltage -10 to 10 V, 4ch Removable terminal block
EH-AY2H	12-bit analog output, Voltage -10 to 10 V, 2ch Removable terminal block
EH-AYH8M	14-bit analog output, Current 0-22 mA, 4-20 mA, Voltage, 0-10 V, 8ch Removable terminal block

Base unit	
Model	Specification
EH-BS3A	3 I/O modules can be installed
EH-BS5A	5 I/O modules can be installed
EH-BS6A	6 I/O modules can be installed
EH-BS8A	8 I/O modules can be installed
EH-BS11A	11 I/O modules can be installed

EH-BS11A is supported by EH-CPU516/548.

Cables for connecting peripheral devices	
Model	Specification
EH-VCB02	Direct connection between EH-150 and a personal computer (2m)
WVCB02H	Connection with a personal computer, EH-RS05 is required. (2m)
EH-RS05	Adapter cable for WVCB02H (0.5m)

I/O controller connecting cable	
Model	Specification
EH-CB05A	Length:0.5m (Between Base unit and EH-IOCH2)
EH-CB10A	Length:1m (Between Base unit and EH-IOCH2)
EH-CB20A	Length:2m (Between Base unit and EH-IOCH2)

I/O controller	
Model	Specification
EH-IOCH2	I/O control module (One unit / one expansion base, EH-CPU104 is not expandable.)
EH-IOCD	DeviceNet slave module, 256-word input and 256- word output
EH-IOCP	PROFIBUS slave module, 209-word input and 209- word output

Counter module, positioning module	
Model	Specification
EH-CU	High-speed counter input, 2ch 32-bit, 100 kHz max.
EH-CUE	High-speed counter input, 1ch 32-bit, 100 kHz max.
EH-POS	1-axis pulse positioning
EH-POS4	4-axes pulse positioning

Communication module			
Model	Specification	Model	Specification
EH-RMD	DeviceNet master module 256- word input, 256-word output, Up to 2 units can be installed per CPU	EH-LNK	CPU Link module (coaxial cable)
EH-RMP	PROFIBUS master module 256- word input, 256-word output, Up to 2 units can be installed per CPU	EH-OLNK	CPU Link module (optical cable)
EH-ETH	Ethernet module IEEE802.3 standard 10 BASE-T	EH-SIO	Serial communication module

Dummy module	
Model	Specification
EH-DUM	Module for an open slot

Output module	
Model	Specification
EH-YT8	8 points, Transistor output, 12/24 V DC, Removable terminal block (Sink type logic)
EH-YTP8	8 points, Transistor output, 12/24 V DC, Removable terminal block (Source type logic)
EH-YT16	16 points, Transistor output, 12/24 V DC, Removable terminal block (Sink type logic)
EH-YTP16	16 points, Transistor output, 12/24 V DC, Removable terminal block (Source type logic)
EH-YTP16S	16 points, Transistor output, 12/24 V DC with short circuit protection, Removable terminal block (Source type logic)
EH-YT32	32 points, Transistor output, 12/24 V DC with short circuit protection, Connector type (Sink type logic)
EH-YTP32	32 points, Transistor output, 12/24 V DC with short circuit protection, Connector type (Source type logic)
EH-YT32E	32 points, Transistor output, 12/24 V DC with short circuit protection, Spring type terminal blk (Sink type logic)
EH-YTP32E	32 points, Transistor output, 12/24 V DC with short circuit protection, Spring type terminal blk (Source type logic)
EH-YT64	64 points, Transistor output, 12/24 V DC with short circuit protection, Connector type (Sink type logic)
EH-YTP64	64 points, Transistor output, 12/24 V DC with short circuit protection, Connector type (Source type logic)
EH-YS4	4 points, Triac output , 100/240 V AC, Removable terminal block, 0.5A
EH-YS16	16 points, Triac output , 100/240 V AC, Removable terminal block, 0.3A
EH-YR12	12 points, Relay output, 100/240 V AC, 24 V DC, Removable terminal block
EH-YR8B	8 points, Independent relay output, Varistor, 100/240 V AC, 24 V DC, Removable terminal block
EH-YR16	16 points, Relay output, 100/240V AC, 24 V DC, Removable terminal block

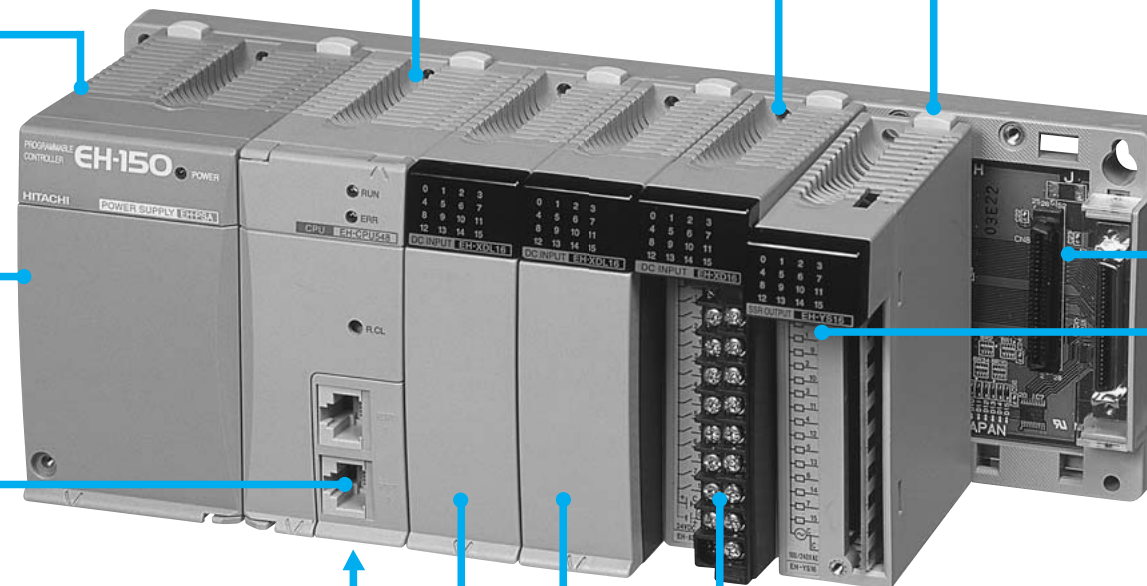

System Configuration

Standalone



●EH-CPU104A

Number of I/O points
128 points maximum
(512 points maximum)
Expansion : impossible



●EH-CPU208A/316A

Number of I/O points
256 points maximum
(1,024 points maximum)
Expansion : 1 maximum



●EH-CPU516

Number of I/O points
528 points maximum
(2,112 points maximum)
Expansion : 2 maximum



●EH-CPU548

Number of I/O points
880 points maximum
(3,520 points maximum)
Expansion : 4 maximum



() : when 64 points I/O modul is used

EH-BS11A is supported by EH-CPU516/548.

EH-150

Application System

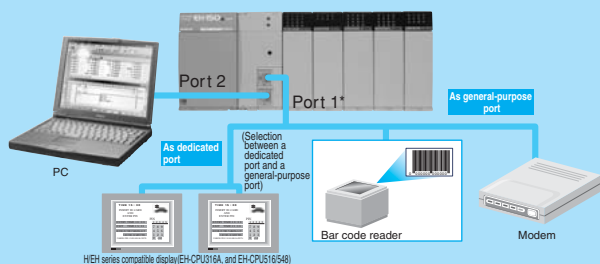

*EH-CPU316A and EH-CPU516/548 can select either RS-232C or RS-422/485 on the general-purpose port or the dedicated port.

●Communication port functions

	Port specification	Interface	Connection mode	Communication protocol	Connected device
Port 1	Dedicated	RS-232C	1 : 1	H-Protocol (procedure 1 or 2)	PC (Programming software or SCADA), HMI, etc.
				AT command, H-Protocol (procedure 1 or 2)	Modem
		RS-422 *	1 : 1	H-Protocol (procedure 1 or 2)	PC (Programming software or SCADA), HMI, etc.
			1 : N	H-Protocol with station number (procedure 1 or 2)	
	RS-485 *	1 : 1	H-Protocol (procedure 1)	PC (Programming software or SCADA), HMI, etc.	
		1 : N	H-Protocol with station number (procedure 1 or 2)		
General purpose	RS-232C	1 : 1	No protocol operated by TRNS/RECV command in user program	Bar code reader, serial printer, PC, etc.	
	RS-422 *	1 : 1, 1 : N			
	RS-485 *	1 : 1, 1 : N			
Port 2	Dedicated	RS-232C	1 : 1	H-Protocol (procedure 1)	PC (Programming software or SCADA), HMI, etc.

* Supported by the EH-CPU316A/516/548

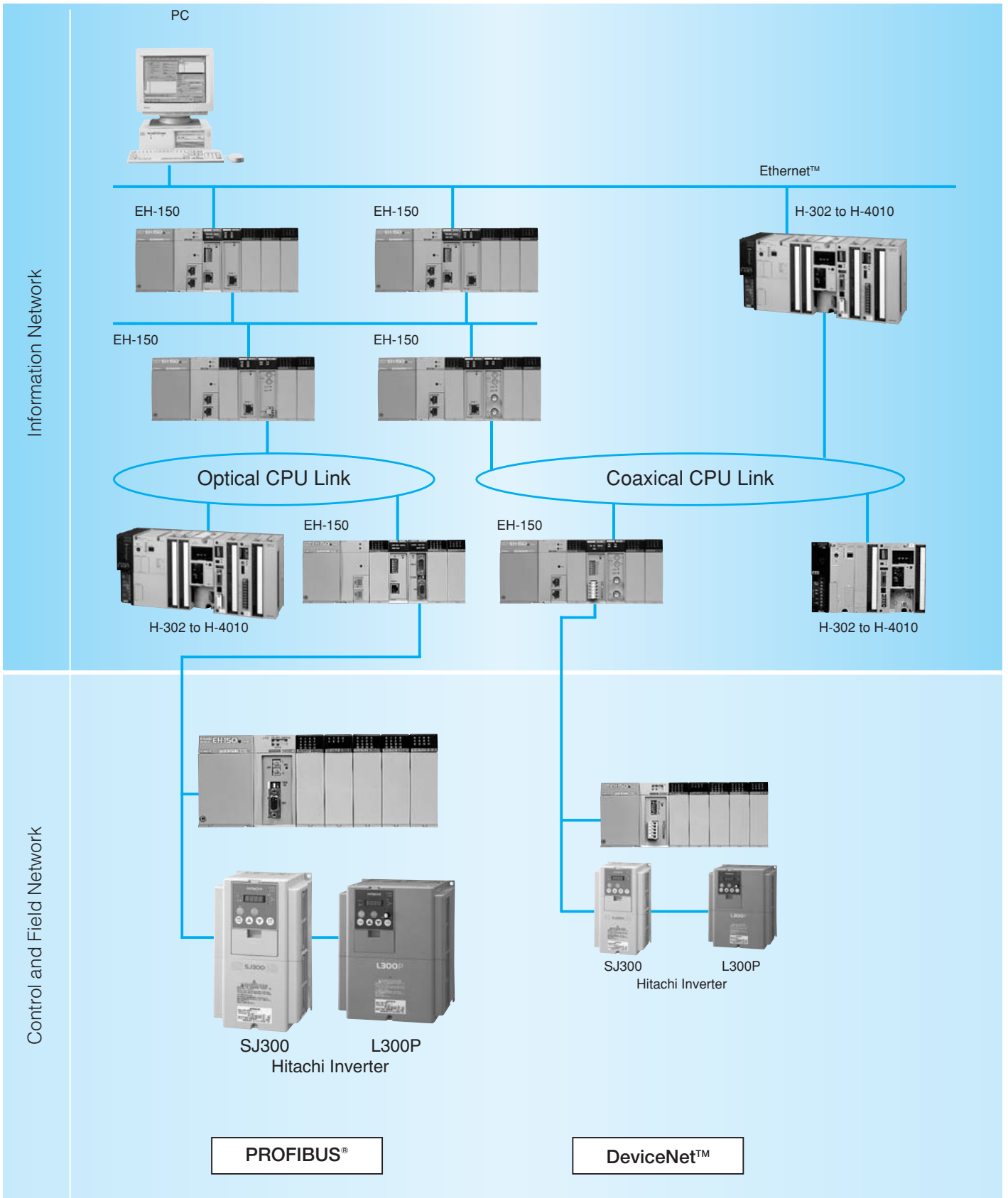

Network System



- DeviceNet is a trademark of Open DeviceNet Vendor Association.
- PROFIBUS is a registered trademark of Profibus Nutzer Organization.
- Ethernet is a trademark of Xerox Corporation.

Specifications

CPU

Model	Name		EH-150				
	Type		EH-CPU104A	EH-CPU208A	EH-CPU316A	EH-CPU516	EH-CPU548
Number of I/O points	16-point I/O module		128 point maximum	256 point maximum		528 point maximum	880 point maximum
	64-point I/O module		512 point maximum	1024 point maximum		2112 point maximum	3520 point maximum
Control specifications	CPU		32-bit RISC processor				
	Processing method		Stored program cyclic method				
	Processing speed	Basic commands	1.0 μs/command			0.1 μs / command	
		Application commands	Several 10 μs/command				
User program memory		4 k steps (RAM) 4 k steps (Flash memory)	8 k steps (RAM) 8 k steps (Flash memory)	16 k steps (RAM) 16 k steps (Flash memory)	48k steps (RAM) 48k steps (Flash memory)		
Calculation processing specifications	Command language	Basic commands	39 types such as LD, LDI, AND, ANI, OR, ORI, ANB, ORB, OUT, MPS, MRD, MPP				
		Arithmetic commands Application commands	116 types	117 types	145 types	153types	
	Ladder	Basic commands	39 types such as 			40 types such as 	
		Arithmetic commands Application commands	116 types	117 types	145 types	153 types	
I/O processing specifications	External I/O	I/O processing method	Refresh processing				
		16 points I/O module	128 points maximum	256 points maximum			
	Internal output	Bit	1,984 points (R0 to R7BF)				
		Word	4,096 words (WR0 to WRFFF)	8,192 words (WR0 to WR1FFF)	22,528 words (WR0 to WR57FF)	50,176 words (WR0 to WR3FFF)	
		Special	Bit	64 points (R7C0 to R7FF)			
			Word	512 words (WRF000 to WRF1FF)			
		CPU link	16,384 points 1,024 words × 2 loops (L0 to L3FFF/L10000 to L13FFF, WL0 to WL3FF/WL1000 to WL13FF)				
	Remote I/O	-			512 points × 4 master stations		
	Timer and counter	Bit/word shared	16,384 points 1,024 words (M0 to M3FFF, WM0 to WM3FF)				
			512 points (TD + CU) However, TD is up to 256 points ^{*1}		512 points (TD + CU) However, TD is up to 256 points ^{*1} 2,048 points (TM) ^{*3}		
Number of points		512 points (TD + CU) However, TD is up to 256 points ^{*1}		512 points (TD + CU) However, TD is up to 256 points ^{*1} 2,048 points (TM) ^{*3}			
Timer set value		0 to 65,535, timer base 0.01s, 0.1s, 1s (64 points are maximum for 0.01s ^{*2})		TD:0 to 65,535, timer base 0.01s, 0.1s, 1s (64 points are maximum for 0.01s ^{*2}) TM:0 to 65,535, timer base 0.01s			
Counter set value	1 to 65,535 times						
	512 points (DIF0 to DIF511: decimal) + 512 points (DFN0 to DFN511: decimal)						
Edge detection							
Weight	Approximately 0.18kg(0.4lb.)			Approximately 0.2kg(0.44lb.)			
Peripheral equipment	Program method	Command language, ladder diagram					
	Peripheral devices	Programming software (LADDER EDITOR for Windows® / LADDER EDITOR DOS version, PRO-H (IEC61131-3)), Command language programmer, Portable graphic programmer, Graphic input device					
Maintenance functions	Self-diagnosis	PC error (LED) display : microcomputer error, watchdog timer error, memory error, program error, system ROM/RAM error, scan time monitoring, battery under-voltage detection, and others					
Additional functions	Clock function, modem control function		-	Yes			
	Memory board		-	Yes			
	Instruction	PID instruction	-	Yes			
		data logging	-	Yes			
		BINARY/ASCII conversion	-	Yes			
	Telecommunication		-	Yes			
	Floating Point		-	Yes			
RS-422/485 interface at general-purpose port		-	Yes				
RS-422/485 interface at dedicated / general-purpose port		-	Yes				

*1: The same numbers cannot be used with the timer and the counter. TD is 0 to 255.

*2: Only timers numbered 0 to 63 can use 0.01s for their timer base.

*3: Supported by LADDER EDITOR for Windows® ver.3

Memory board

Item	EH-MEMP	EH-MEMD
Program capacity	See page 2	See page 2
Data capacity	-	384k words
Program transfer function	Yes	Yes
Memory	Flash	Flash
Weight	Approximately 0.05kg (0.11lb.)	

Power supply module

Item	EH-PSA	EH-PSD
Input	Rated voltage	85 to 264V AC
	Current	1A or less (85 to 264V AC)
	Inrush current	50 A or less (Ta = 25°C), 100 A or less (Ta = 55°C)
Output	5V DC	3.8A
	24V DC	0.4A
Weight	Approximately 0.36kg (0.79lb.)	

DC and AC Input Module

Item	Specification				
	EH-XD8	EH-XD16	EH-XDL16	EH-XA16	EH-XAH16
Type	DC input			AC input	
Input specification					
Input voltage	24 V DC			100 to 120 V AC	200 to 240 V AC
Allowable input voltage range	19.2 to 30 V DC			85 to 132 V AC	170 to 264 V AC
Input impedance (Approximately)	3.5k Ω		5.9 k Ω	16 k Ω (50 Hz), 13 k Ω (60 Hz)	32 k Ω (50 Hz), 27 k Ω (60 Hz)
Input current (Approximately)	6.9mA		4.0mA	4.8 to 7.6mA (100 V AC / 50Hz)	4.3 to 8.0mA (200 V AC / 50Hz)
Operating voltage	ON voltage			79 V AC	164 V AC
	OFF voltage			20 V AC	40 V AC
Input lag	OFF \rightarrow ON		16 ms or less (13 ms TYP)	15 ms or less	
	ON \rightarrow OFF		16 ms or less (13 ms TYP)	25 ms or less	
Number of input points	8 points / module	16 points / module		16 points / module	
Number of common points	2 common points / 8 inputs*	2 common points / 16 inputs*		2 common points / 16 inputs*	
Polarity	None			None	
Insulation method	Photocoupler insulation			Photocoupler insulation	
Input display	LED (green)			LED (green)	
Weight	Approximately 0.16kg(0.35lb.)			Approximately 0.18kg(0.4lb.)	
External connection	Removable screw terminal block (M3)			Removable screw terminal block (M3)	
Internal current consumption (5V DC)	Approximately 30 mA	Approximately 50 mA		Approximately 50 mA	Approximately 50 mA

*Commons are connected internally.

Transistor Output Module

Item	Specification				
	EH-YT8	EH-YT16	EH-YTP8	EH-YTP16	EH-YTP16S (with short-circuit protection)
Output specification	Transistor output (sink type)			Transistor output (source type)	
Rated load voltage	12/24 V DC (+10%, -15%)			12/24 V DC (+10%, -15%)	
Minimum switching current	1mA			1mA	
Leak current	0.1mA			0.1mA	
Maximum load current	1 point	0.5A			0.8A
	1 common	2.4A	4A	2.4A	4A
Output response time	OFF \rightarrow ON			0.3 ms or less	
	ON \rightarrow OFF			1 ms or less	
Number of output points	8 points / module	16 points / module		8 points / module	16 points / module
Number of common points	1 common point / 8 outputs*	1 common point / 16 outputs*		1 common point / 8 outputs*	1 common point / 16 outputs*
Surge removal circuit	Diode			Diode	Built-in
Fuse ¹	4 A / common		8 A / common	4 A / common	8 A / common
Insulation method	Photocoupler insulation			Photocoupler insulation	
Output display	LED (green)			LED (green)	
Weight	Approximately 0.16kg(0.35lb.)				
External connection	Removable screw terminal block (M3)			Removable screw terminal block (M3)	
Internal current consumption (5 V DC)	Approximately 30 mA	Approximately 50 mA		Approximately 30 mA	Approximately 50 mA
External power supply ² (For supplying power to the S terminal)	12/24 V DC (+10%, -15%) (maximum 30 mA)			12/24 V DC (+10%, -15%) (maximum 30 mA)	

*1: The module needs to be repaired in case a load short causes a blown fuse. Furthermore, the fuse cannot be replaced by the user. *2: It is necessary to supply 12/24 V DC externally to the S terminal.

Relay and AC (SSR) Output Module

Item	Specification				
	EH-YR8B	EH-YR12	EH-YR16	EH-YS4	EH-YS16
Output specification	Independent relay output	Relay output		Triac output	
Rated load voltage	100/240 V AC, 24 V DC			100/240V AC (85 to 250V AC)	
Minimum switching current	1 mA (5V DC except after switching with excessive current)				
Leak current	None			5mA or less	2mA or less
Maximum load current	1 point	2A		0.5A	0.3A
	1 common	2A	5A	8A	4A (Derating diagram)
Output response time	OFF \rightarrow ON			10 ms or less	
	ON \rightarrow OFF			10 ms or less	
Number of output points	8 points/module	12 points / module	16 points/module	4 points / module	16 points / module
Number of common points	1 common point / 1 output	1 common point / 12 outputs (Common terminal is 2 points) ¹	1 common point / 16 outputs (Common terminal is 2 points) ¹	1 common point / 4 outputs	1 common point / 16 outputs (Common terminal is 2 points) ¹
Surge removal circuit	Varistor (voltage characteristic of varistor : 423~517V)			None	
Fuse	None			4 A / 1 common	6.3 A / 1 common ³
Insulation method	Relay insulation	Photocoupler insulation	Relay insulation	Photo-triac insulation	
Output display	LED (green)				
Weight	Approximately 0.16kg(0.35lb.)	Approximately 0.20kg(0.44lb.)	Approximately 0.16kg(0.35lb.)	Approximately 0.18kg(0.40lb.)	Approximately 0.23kg(lb.)
External connection	Removable type screw terminal block (M3)				
Internal current consumption (5 V DC)	Approximately 220 mA	Approximately 40 mA	Approximately 430 mA(Approximately 430 mA) ²	Approximately 70mA	Approximately 250mA
Externally supplied power ² (for driving relays)	Not used	24 V DC (+10%, -5%) (maximum 70 mA)	Not used	Not used	Not used

*1: The common terminals are connected internally.

*2: 24 V DC must be supplied externally to drive the relays. (The 24 V output of the power module may be used.)

*3: Be sure to connect the fuse to external wiring

EH-YS16 Derating diagram

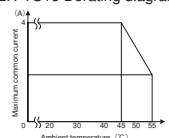

32-/64-point DC Input Module



EH-XD32

EH-XD64

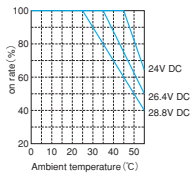

Item	Specification	
	EH-XD32	EH-XD64
Type	DC input	
Input specification	24 V DC	
Input voltage	24 V DC	
Allowable input voltage range	19.2 to 30 V DC	20.4 to 28.8 V DC
Input impedance	Approximately 5.6 kΩ	
Input derating	See the derating chart	
Input current	Approximately 4.3 mA	
Operating voltage	ON voltage	15 V or more
	OFF voltage	5 V or less
Input lag	OFF → ON	5 ms or less
	ON → OFF	5 ms or less
		1 ms or less
Number of input points	32 points / module	64 points / module
Number of common points	32 points / 1 common (common terminal is 4 ¹⁾)	
Polarity	None	
Insulation method	Photocoupler insulation	
Input display	LED (green) ²	
Weight	Approximately 0.15kg(0.33lb.)	Approximately 0.14kg(0.31lb.)
External connection	Connector	
Internal current consumption (5V DC)	Approximately 60 mA	Approximately 80 mA

*1: Commons are connected internally.

*2: There are 16 LED displays. Use the toggle switch to select a group of input points to be displayed.

32-/64-point DC Output Module



EH-YT32
EH-YTP32

EH-YT64
EH-YTP64

Item	Specification			
	EH-YT32	EH-YTP32	EH-YT64	EH-YTP64
Type	Transistor output (sink type)	Transistor output (source type)	Transistor output (sink type)	Transistor output (source type)
Output specification	12 / 24 V DC (+10%, -15%)			
Rated load voltage	12 / 24 V DC (+10%, -15%)			
Minimum switching current	1 mA			
Leak voltage	0.1 mA or less			
Maximum load current	1 point	0.2 A		0.1 A
	1common	4.0 A ^{*1}		3.2 A
Output response time	OFF → ON	0.3 ms or less		
	OFF → OFF	1 ms or less		
Number of output points	32 points / module		64 points / module	
Number of common points	32 points / 1 common			
Surge removal circuit	Diode			
Fuse ^{*2}	10 A / 1 common		5 A / 1 common	
Insulation method	Photocoupler insulation			
Output display	LED (green) ^{*3}			
Short-circuit protection	Short-circuit protection function			
Weight	Approximately 0.16kg(0.35lb.)		Approximately 0.13kg(0.29lb.)	
External connection	Connector			
Internal current consumption (5 VDC)	Approximately 90 mA		Approximately 120 mA	
External power supply ^{*4} (For supplying power to the S terminal)	12 / 24 VDC (+10%, -15%) (Maximum 100 mA)			

*1: Total current for 4 common pins. The maximum current for 1 pin is 3A.

*2: The fuse is soldered in the PC board. When it is blown, it is not allowed for user to replace as safety reason.

*3: There are 16 points for each LED display. The displayed group is toggled using a switch.

*4: It is necessary to supply 12/24 V DC to the S terminal

Spring type terminal 32-points DC Input Module



Item	Specification	
	EH-XD32E	EH-XDL32E
Type	DC input	
Input specification	24 V DC	
Input voltage	24 V DC	
Allowable input voltage range	20.4 to 28.8 V DC	
Input impedance	Approximately 5.6 kΩ	
Input current	Approximately 4.3mA (24VDC)	
Operating voltage	ON voltage	15 V or more
	OFF voltage	5 V or less
Input lag	OFF → ON	1 ms or less
	ON → OFF	1 ms or less
Number of input points	32 points/module	
Number of common points	8 points/1 common (number of common terminals is 4)	
Polarity	None	
Insulation isolation	Photocoupler isolation	
Input display	LED (green) ^{*1}	
External connection	Euro-terminal	
Internal current consumption (5 V)	Approximately 60 mA	

*1: There are 16 points for each LED display. The displayed group is toggled using a switch. And, LED display is renewed by refresh processing.

Spring type terminal 32-points DC Output Module



Item	Specification	
	EH-YT32E	EH-YTP32E
Type	Transistor output (sink type)	Transistor output (source type)
Output specification	12/24 V DC (+10%, -15%)	
Rated load voltage	12/24 V DC (+10%, -15%)	
Minimum switching current	1 mA	
Leak current	0.1 mA or less	
Maximum load current	1 point	0.2 A
	1 common	1.0 A
Output response time	OFF → ON	0.3 ms or less
	ON → OFF	1 ms or less
Number of output points	32 points/module	
Number of common points	8 points/1 common (number of common terminals is 4)	
Surge removal ladder	Diode	
Fuse ¹	10 A/common	
Isolation system	Photocoupler isolation	
Output display	LED (green) ²	
Short-circuit protection	Built-in short-circuit protection function	
External connection	Euro-terminal	
Internal current consumption (5 V DC)	Approximately 90 mA	
External power supply ³ (For supplying power to the S terminal)	12/24 V DC (+10%, -15%) (maximum 30 mA)	

*1: The module needs to be repaired when a fuse blows out. Because the fuse can not be replaced by the user, please send back the module to our distributors for repair in such case.

*2: There are 16 points for each LED display. The display group is switched using a switch. And, LED display is renewed by refresh processing.

*3: It is necessary to supply 12/24 V DC from outside to the S terminal.

Terminal Block for 32/64 points I/O module



Features

- With one cable, the terminal block can be connected to a 32/64-point I/O module.
- Width of the terminal block is 40mm. It saves installation space.
- Terminal screws are retention-type. A closed-loop terminal connector can be easily attached without removing a screw.
- The terminal block can be snapped on a DIN rail.
- Connection cables between the terminal block and a 32/64-point I/O module are available.



Item	Specification
Type	HPX7DS-40V6
Number of terminals	40
Terminal width	7.62
Applicable cable	Max. 1.25mm ²
Tightening torque	0.5 – 0.75N·m
Terminal screw	M3 x 6L
Rated voltage	125 V
Rated current	1 A
Dielectric withstand voltage	500 V AC for 1 minute (Against ground: 1000 V AC for 1 minute)
Insulation resistance	1000 M Ω or more between charge and ground (500 V mega)
Vibration resistance	10 – 50Hz / dual-amplitude 1.5 mm
Shock resistance	491m/S ² (50G) or more

Cables for 32/64-point module

With a connector at each end		With a connector at one end	
Type	Cable length	Type	Cable length
EH-CBM01W	1 m	EH-CBM01	1 m
EH-CBM03W	3 m	EH-CBM03	3 m
EH-CBM05W	5 m	EH-CBM05	5 m
EH-CBM10W	10 m	EH-CBM10	10 m



Analog Input Module

Item	Specification				
Type	EH-AX44	EH-AX8V	EH-AX8H	EH-AX8I	EH-AX8IO
Current input range	4 to 20 mA (Ch. 0 to 3)	—	—	4 to 20 mA	0 to 22 mA
Voltage input range	0 to 10 V DC (Ch. 4 to 7)	0 to 10 V DC	-10 to 10 V DC	—	—
Resolution	12 bits				
Conversion time	5 ms or less				
Overall accuracy	±1% or less (of full-scale value)				
Input impedance	Current input	Approximately 100 Ω	—	—	Approximately 100 Ω
	Voltage input	Approximately 100 k Ω			
Insulation	Channel - Internal circuit	Photocoupler insulation			
	Between channels	No insulation			
Number of channels	Current input	4 channels / module (Ch. 0 to 3)	—	—	8 channels/module
	Voltage input	4 channels / module (Ch. 4 to 7)	8 channels/module	—	—
Weight	Approximately 0.18 kg (0.4 lb.)				
External connection	Removable screw terminal block (M3)				
Internal current consumption (5 V DC)	Approximately 100 mA				
External power supply	24 V DC (+20%, -15%) Approximately 0.15 A (Approximately 0.4 A at power On)				
External wiring	2-core shield wire (20 m (65.62 ft.) or less)				

Analog Output Module

Item	Specification				
Type	EH-AY22	EH-AY4V	EH-AY4H	EH-AY2H	EH-AY4I
Voltage output range	0 to 10 V DC (Ch. 0 to 1)	0 to 10 VDC	-10 to 10 V DC	—	—
Current output range	4 to 20 mA (Ch. 2 to 3)	—	—	—	4 to 20 mA
Resolution	12 bits				
Conversion time	5 ms or less				
Overall accuracy	±1% or less (of full-scale value)				
External load resistor	Voltage output	10 k Ω or more			—
	Current output	0 to 500 Ω	—	—	0 to 350 Ω
Insulation	Channel - Internal circuit	Photocoupler insulation			
	Between channels	No insulation			
Number of channels	Voltage output	2 channels / module (Ch. 0 to 1)	4 channels / module	2 channels / module	—
	Current output	2 channels / module (Ch. 2 to 3)	—	—	4 channels / module
Weight	Approximately 0.18 kg (0.4 lb.)				
External connection	Removable screw terminal block (M3)				
Internal current consumption (5 VDC)	Approximately 100 mA				
External power supply	24 V DC (+20%, -15%) Approximately 0.15 A (Approximately 0.5 A at power On)				
External wiring	2-core shield wire (20 m (65.62 ft.) or less)				

Resistance Temperature Detective Input Module

Item	Specification	
Type	EH-PT4	
Temperature-sensing element	Platinum resistance temperature detector Pt 100 (JIS C 1604-1989) / Pt 1000	
Temperature conversion data	Signed 15 bits	
Accuracy *1	-20°C to 40°C (Pt 100)	±0.1°C @ 25°C ±0.5°C (0 to 55°C)
	-50°C to 400°C (Pt 100)	±0.6°C @ 25°C ±3°C (0 to 55°C)
	-50°C to 400°C (Pt 1000)	±0.8°C @ 25°C ±6°C (0 to 55°C)
Temperature measuring range	-20 to +40°C / -50 to +400°C (2 mA constant current system)	
Number of input points	4	
Conversion time	Approximately 0.5 second per four inputs	
Insulation	Between input and internal circuit	Photocoupler insulation
	Between inputs	No insulation
Weight	Approximately 0.15 kg (0.33lb.)	
External Connection	Removal terminal block (M3)	
Unused terminal processing	Unused terminals (for current, voltage and ground) should be shorted at the terminal block (Temperature conversion data for one of the four values is H7FFF)	
External wiring register	The maximum total wiring resistance from current terminal to ground terminal is 2 Ω.	
External wiring	3 cores shielded cable	
Additional function	Linearization	
	-20°C to 40°C (Pt100)	0.0024°C
	-50°C to 400°C (Pt100)	0.024°C
Resolution	0.024°C	
Internal current consumption (5V DC)	Approximately 160mA	
Externally supplied power	24V DC ±10%, Maximum current consumption is 70mA	

*1: Accuracy 10 minutes after power on.

Thermocouple Input Module

Item	Specification	
Type	EH-TC8	
Number of input points	8 points / module	
Type of sensor	K, E, J, T, B, R, S, N (Selected by the setting switch on the PWB)	
Insulation	Photocoupler (Channel - internal circuit)	
Conversion time	860 ms / 8 channels or 108 ms / 8 channels (Selected by the setting switch on the PWB)	
Temperature conversion data	15 bits binary data (Negative values are indicated in two's complements)	
Resolution	0.1°C/0.1°F (Selected by the setting switch on the PWB), 1°C/1°F (B, R, S)	
Accuracy	+/- 0.3 to 1.0% FS	
Error detection	Turn on LED and Value 7FFFH (Each channel)	
Internal current consumption (5V DC)	Approximately 70mA	
External power source	24V DC	

Analog Input Module

Item	Specification	
Model name	EH-AXH8M	
Input range (Selected by the switch.)	Voltage 0 to 10 V DC/-10 to 10 V DC	
	Current 0 to 22 mA/4 to 22 mA	
Resolution (Selected by the switch)	0 to 10 V	Voltage 1 mV or 1/16384 (14 bits)
Conversion time	0 to 22 mA	Current 0.002 mA or 1/16384 (14 bits)
Overall accuracy	8.9 ms / 8 channels	
Linearity	Voltage ±0.5% or less (Full scale)	
	Current ±0.8% or less (Full scale)	
Input filter (Selected by the switch)	Enable	Approx. 90 ms (to reach 90% after step input)
	Disable	18 ms or less (to reach 90% after step input)
Input impedance	Voltage	Differential 200 k Ω
	Current	249 Ω
Isolation	Between channel and internal bus	Photo coupler
	Between channels	Not isolated
Number of channel	Differential voltage input 8 ch. or Current input 8 ch. (selected per 4 ch.)	
Weight	Approx 0.15kg(0.35lb.)	
I/O assignment	WX8W	
Wiring	Removable terminal block (M3)	
Internal current consumption (5VDC)	Max. 70mA	
External power supply	24 V DC (+20%, -15%) Approx. 0.04 A (Approx. 0.3 A at power on)	
Cable	Shielded pair cable (Max. 20m)	

Analog Output Module

Item	Specification	
Model name	EH-AYH8M	
Output range (Selected by the switch)	Voltage 0 to 10 V DC	
	Current 0 to 22 mA/4 to 22 mA	
Resolution (Selected by the switch)	Voltage 1 mV or 1/16384 (14 bits)	
Conversion time	Current 0.002 mA or 1/16384 (14 bits)	
Overall accuracy	8.9 ms / 8 channels	
Linearity	±0.8% or less (Full scale)	
	±0.2% or less (Full scale, in range 0 to 10V / 0.05 to 22mA)	
Output filter * (Selected by the switch)	Disable	18 ms or less (to reach 90% of set value)
	Enable	200 ms or less (to reach 90% of set value)
Output impedance	Voltage	Min. 10 k Ω
	Current	Max. 400 Ω
Isolation	Between channel and internal bus	Photo coupler
	Between channels	Not isolated
Number of output channel	Voltage output 8 ch. or Current output 8 ch. (selected per 4 ch.)	
Weight	Approx 0.18 kg (0.4lb.)	
I/O assignment	WY8W	
Wiring	Removable terminal block (M3)	
Internal current consumption (5VDC)	Max. 70mA	
External power supply	24 V DC (+20%, -15%) Approx. 0.15 A (Approx. 0.4 A at power on)	
Cable	Shielded pair cable (Max. 20m)	

Internal Circuit Diagram

DC Input (8, 16, 32 and 64 points)

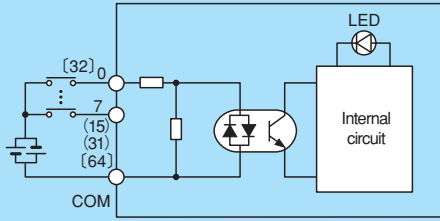

Model: EH-XD8, EH-XD16, EH-XD16, EH-XD32, EH-XD64

AC Input (16 points)

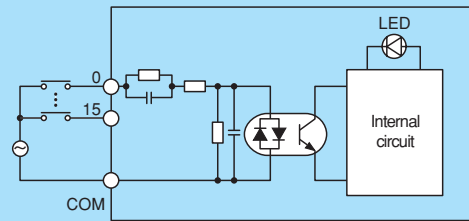

Model: EH-XA16, EH-XAH16

Transistor Output (8,16, 32 and 64 points) Sink Type

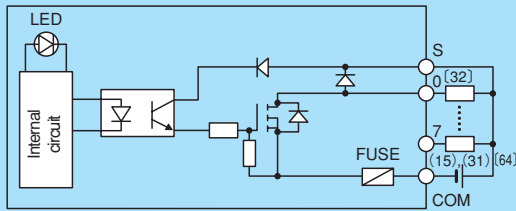

Model: EH-YT8, EH-YT16, EH-YT32, EH-YT64

Transistor Output (8,16, 32 and 64 points) Source Type

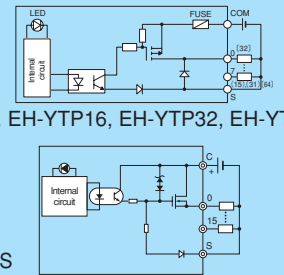

Model: EH-YTP8, EH-YTP16, EH-YTP32, EH-YTP64

Model: EH-YTP16S

Relay Output (8, 12 and 16 points)

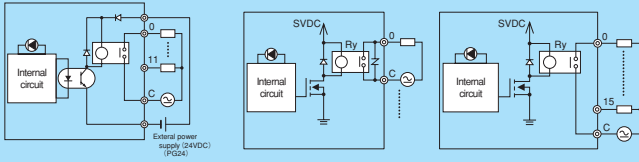

Model: EH-YR12

Model: EH-YR8B

Model: EH-YR16

AC (SSR) Output (4 points)

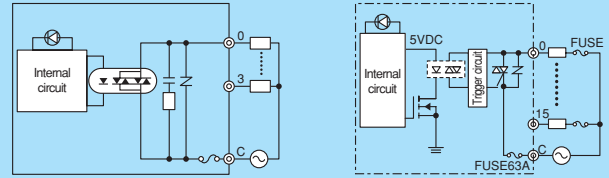

Model: EH-YS4

Model: EH-YS16

Analog Input

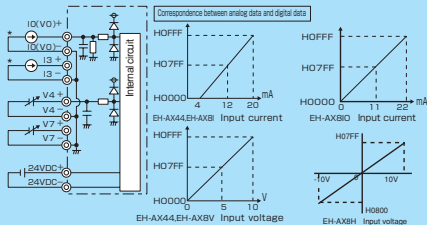

Model: EH-AX44, EH-AX8V, EH-AX8H, EH-AX8I, EH-AX8IO

* In the case of EH-AX44, current input.

Analog Output

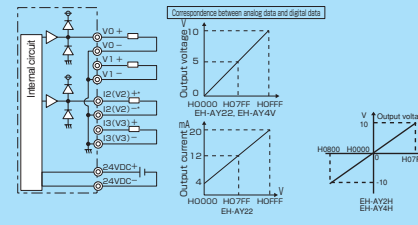

Model: EH-AY22, EH-AY2, EH-AY4V, EH-AY4H

* In the case of EH-AY22, current output.

Analog Input (EH-AXH8M)

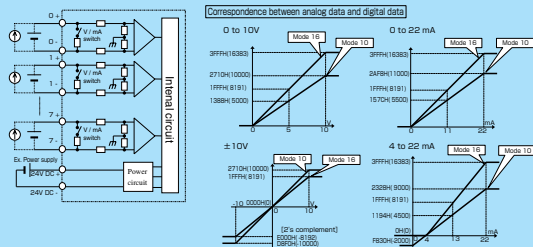

Model: EH-AXH8M

Analog Output (EH-AYH8M)

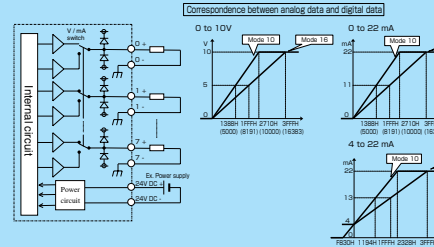

Model: EH-AYH8M

Counter Module



Item		Specification		
Type		EH-CU	EH-CUE	
Counter specification	Maximum number of count	32 bit (0 to 4, 294, 967, 295)		
	Maximum frequency	100 kHz (25 kHz when multiple of 4)		
	Count mode	Select via dip switch settings. (Common to both channels for the EH-CU.) 2 phases; 1 phase (cw/ccw, ck, U/D); 2 phases, multiplication by 4		
	Number of channels	2 channels	1 channel	
	Differential current	4 mA or higher		
	Differential input voltage	12 to 24 VDC		
		10 V DC		
		4 V DC		
	Insulation method		Photocoupler	
	Number of input points	Phase difference of each channel (A - B) during 2-phase counting +45° to +125° when up, -45° to -125° when down		
		A: A, CW, CK		
		B: B, CCW, U/D M: Marker (2)		
	Minimum counter pulse width	ON: 4µs or higher, OFF: 4µs or higher		
	Minimum marker pulse width	10µs or higher (Detected via ON edge)		
External wiring method		30-Pin batch connector for both channels	30-pin connector	
External wiring		Wired with twisted pair wires and batch shielded wires		
Output voltage		12/24 VDC (30 VDC maximum)		
Load current		20 mA / point maximum		
Output method		Open collector output		
Minimum load current		1 mA		
Output delay time	ON → OFF	1 ms or less		
	OFF → ON	1 ms or less		
Voltage drop when ON		1.5 V maximum		
Number of external output points	4 points / module		2 points / module	
	Normal counter	Current value = Set Value 1 or current value > Set Value 1		
	Ring counter	Current value = Set Value 2		
Leak current		0.5 mA maximum		
Polarity		(-) common within the module		
External power supply		12/24 VDC (30 VDC maximum)		
Insulation method		Photocoupler		
Weight		Approximately 0.16kg(0.35lb.)		
Internal current consumption		5 V 310 mA		

1-axis Pulse Positioning Module



Item		Specification			
Type		EH-POS			
Number of control axes		1-axis			
Highest frequency		400 k pulse/s			
Positioning data	Capacity	256 points			
	Setting procedures	Sequence program			
Method		Absolute system / Absolute system + increment system / Increment system			
Positioning command		Pulse specification / µm specification / inch specification / degree specification			
Speed command		Automatic, manual, home position return 6.25 pulse/s to 400 k pulse/s µ m/s, inch/s, degree/s input function			
Speed stage		10 stages			
Acceleration / deceleration system		Trapezoid acceleration / deceleration S-curve acceleration / deceleration (3-stage acceleration / deceleration)			
Acceleration / deceleration time		1 to 65,535 ms			
Backlash		0 to 255 pulse			
High / low limit setting		+2,147,483,647 to -2,147,483,648 pulse			
Pulse output method		Pulse chain (CW / CCW) / Clock + direction signal (CK / direction) (Use dip switches 1 and 2 to select the pulse output method and to switch between positive and negative logic for the selected method.)			
Pulse output procedures		Open collector output (Photocoupler insulation) / Line driver output (Photocoupler insulation)			
Home position return function		Arbitrary origin / Low speed origin return / High speed origin return 1 / High speed origin return 2 / Absolute value encoder home position return			
Manual (JOG) operation		Possible			
Teaching		Pulse output by manual input signal			
Operation when the CPU has stopped		Operation may be performed via I/O setting or using the positioner.			
Absolute value encoder input		Supports the Σ series and Σ II series by Yasukawa Denki and the P series by Sanyo Denki, AD series by Hitachi.			
I/O interface specification	Output	Pulse train (CW / CCW) output Clock + direction signal (CK / direction) Pulse output	1. Open collector output Photocoupler insulation (30 VDC maximum, 30 mA resistive load) 2. Line driver output Photocoupler insulation (5 VDC)		
		Maximum leakage current	100µA or less		
		Maximum voltage drop at ON	0.8 V maximum (at output current 30 mA)		
	Input	Input voltage	10.8 to 30 VDC		
		Input impedance	Approximately 2.2 kΩ		
		Operation voltage	Minimum ON voltage	9 V	
			Maximum OFF voltage	3.6 V	
		Input lag	ON → OFF	1 ms or less	
			OFF → ON	1 ms or less	
		Polarity	Only the encoder signal input uses the plus common inside the module. Other inputs do not specify polarity.		
Insulation method	Photocoupler				
Weight		Approximately 0.17kg(0.37lb.)			
Internal current consumption		5 V DC, 300 mA, 600 mA (When the positioner is connected) .			
External power supply		5 V DC ±5%, 100 mA (For pulse chain output) 24 V DC, 10 mA/point (For external control input)			

Note 1: Stopping the CPU during operation causes the motor to decelerate and come to a stop.

Note 2: The maximum travel per single movement is 2,147,483,647 pulses. When an operation attempts to move beyond the maximum travel, the motor decelerates and stops at the maximum travel position.

4-axes Pulse Positioning Module



Function Specification

Item		Specification	
Type		EH-POS4	
Number of controlled axes		4-axes	
Number of interpolation axes		Linear interpolation : up to 4 axes Circular interpolation : 2 axes	
Maximum speed		1 M pulse/ s	
Positioning data	Number of positioning points	Maximum 256 points/ axis (storage in the module)	
	Setting method	1) Ladder Program 2) Positioning Data Setting tool	
Positioning	Positioning mode	1) Absolute mode 2) Absolute and Incremental 3) Incremental	
	Positioning Unit	1) Pulse 2) μ m 3) inch 4) degree	
	Speed unit	1 pulse/ s - 1M pulse/ s (Auto, Manual, Homing) μ m /s , inch/s , degree/s (selectable by common parameter)	
	Number of speed stage	Maximum 256 stages (in continuous operation)	
	Acceleration and Deceleration	Linear S-curve (3 types)	
	Acceleration and Deceleration time	1 up to 65 535 ms	
	Backlash	0 - 65 535 pulses	
	Operation range	- 2,147,483,648 up to + 2,147,483,647 pulses - 214,748,364.8 up to + 214,748,364.7 μ m - 21,474.83648 up to +21,474.83647 inch - 21,474.83648 up to + 21,474.83647 degree	
	Pulse train signal	1) 2 Pulse signal (CW pulse and CCW pulse) 2) Pulse and Direction signal (PLS and SIG) (Selectable by common parameter)	
Output method		Line driver	
Homing		1) Free home position 2) Low speed homing 3) High speed homing 1 (Off edge stop) 4) High speed homing 2 (Phase Z input stop) 5) Absolute encoder homing	
Applied servo amp in absolute homing		Hitachi AD series	
Manual operation		Manual command	
Teaching function		Teaching command	
Operation on CPU stopping		Available	
Output	Pulse & Sign	Line driver (SN75158(TI))	
	"High" voltage	Minimum 2.4 V	
	"Low" voltage	Maximum 0.4 V	
Phase input	Phase Z input and Absolute encoder serial signal	Line driver (input impedance: 220 ohm)	
Input	Input voltage	20.4 up to 28.8 V DC	
	Input impedance	Approx. 5.6 k ohm	
	Input current	Approx. 4.3 mA (24 V DC)	
	Operation voltage	"ON" voltage	Minimum 15 V DC
		"OFF" voltage	Maximum 5 V DC
	Delay	"ON" to "OFF"	Maximum 1 ms
		"OFF" to "ON"	Maximum 1 ms
	Polarity		No
	isolation		Photo-coupler
Weight		Approximately 0.13kg(0.29 lb.)	
Consumption current		5 V DC , 850 mA (supplied from Power module)	
External power supply		24 V DC, approx. 4.3 mA /point (for external input)	

Note 1: EH-POS4 is supported by EH-CPU316A/516/548

2: When CPU is turned "RUN" to "STOP" or "STOP" to "RUN", the servo motor stops.

Communication Module

DeviceNet™ Master/Slave Module

System configuration



EH-RMD



EH-IOCD

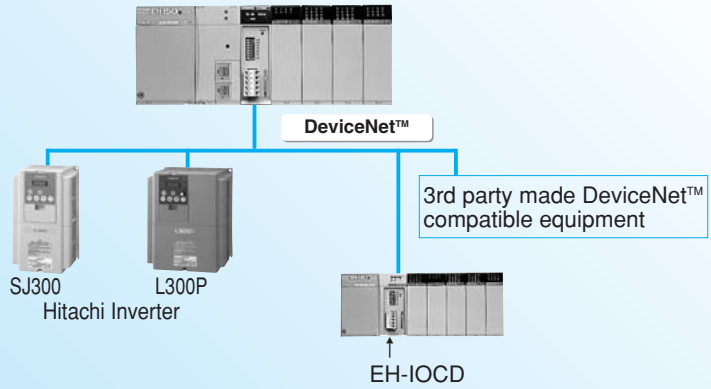

General Specifications

Item	Specification	
	EH-RMD	EH-IOCD
Internal current consumption	5V DC 280 mA	5V DC 320 mA
Weight	Approximately 0.15 kg (0.33 lb.)	Approximately 0.17 kg (0.37 lb.)
External power supply	100 (3.94) 24 V DC ± 10 % (supplied from communication connector)	
Mounted slot position	Only slot 0 to 2 on basic base, Max. two times / CPU	CPU Slot

Performance Specifications

Item	Specification			
	EH-RMD		EH-IOCD	
	LINK mode		REMOTE mode	
No. of installed units	2 units (only on communication slot *)		4 units (only on communication slot)	
No. of slave-connected units	63 units			
I/O assignment	LINK		REMOTE2	
Output data	256 words (WL0-)		64 words (WX1000-, WY1000-)	
Input data	256 words (WL200-)			
Communication protocol	DeviceNet 2.0 standard			
Supported connections	1) Poll I/O connection 2) Bit strobe I/O connection 3) Cyclic I/O connection 4) Change of state (COS) I/O connection 5) Explicit message connection			
Connection mode	1) Multi-drop connection 2) Multi-branch connection using T branch			
Communication speed	500k/250k/125kbps (set by DIP switches)			
Cable	Dedicated DeviceNet cable			
Communication distance	Communication speed	Maximum network length	Each sub-line length	Total sub-line length
	500 kbps	100 m or less	6 m or less	39 m or less
	250 kbps	250 m or less	6 m or less	78 m or less
	125 kbps	500 m or less	6 m or less	156 m or less
The maximum network length shows the value when a thick trunk cable is used.				

Note 1 : EH-RMD is supported by EH-CPU316A/516/548.
 2 : Please prepare the configuration software for set-up.

Node Address and Communication Speed Settings

Node address	NA1	NA2	NA4	NA8	NA16	NA32
0	OFF	OFF	OFF	OFF	OFF	OFF
1	ON	OFF	OFF	OFF	OFF	OFF
2	OFF	ON	OFF	OFF	OFF	OFF
62	OFF	ON	ON	ON	ON	ON
63	ON	ON	ON	ON	ON	ON
Baud rate	DR0		DR1			
125	OFF		OFF			
250	ON		ON			
500	OFF		ON			

Supported I/O Modules

The I/O modules that are supported by the EH-IOCD are as follows:

Type	Input size (word)	Output size (word)
EH-XD8		
EH-XD16		
EH-XDL16	1	0
EH-XA16		
EH-XAH16		
EH-XD32		
EH-XD32E	2	0
EH-XDL32E		
EH-XD64	4	0
EH-PT4	4	0
EH-AX44		
EH-AX8V		
EH-AX8H	8	0
EH-AX8I		
EH-AX8IO		
EH-AXH8M		
EH-TC8		
EH-YT8		
EH-YT16		
EH-YTP8		
EH-YPT16		
EH-YTP16S	0	1
EH-YS4		
EH-YS16		
EH-YR8B		
EH-YR12		
EH-YR16		
EH-YT32		
EH-YTP32	0	2
EH-YT32E		
EH-YTP32E		
EH-YT64	0	4
EH-YTP64		
EH-AY22		
EH-AY2H		
EH-AY4V	0	8
EH-AY4H		
EH-AY4I		
EH-AYH8M		
EH-POS	4	4
EH-POS4		
EH-CU	5	3
EH-CUE		

Item	Specification			
	EH-IOCD			
Number of installed I/O modules	16 units / EH-IOCD (Use the EH-IOCH2 to install 9 or more units.)			
Output data	256 words			
Input data	256 words			
Communication protocol	DeviceNet 2.0 standard			
Supported connections	Poll I/O connection / Bit Strobe I/O connection / Cyclic I/O connection / Change of state (COS) I/O connection / Explicit message connection			
Connection mode	Multi-drop connection / Multi-drop connection using T branch			
Baud rate	500 k / 250 k / 125 kbps (switched by DIP switches)			
Cable	Dedicated DeviceNet Cable (see Note below)			
Communication distance	Communication speed	Maximum network length	Each sub-line length	Total sub-line length
	500 kbps	100 m or less	6 m or less	39 m or less
	250 kbps	250 m or less	6 m or less	78 m or less
	125 kbps	500 m or less	6 m or less	156 m or less
The maximum network length shows the value when a thick trunk cable is used.				

*DeviceNet is a trademark of Open DeviceNet Vendor Association.

Serial communication Module

System configuration

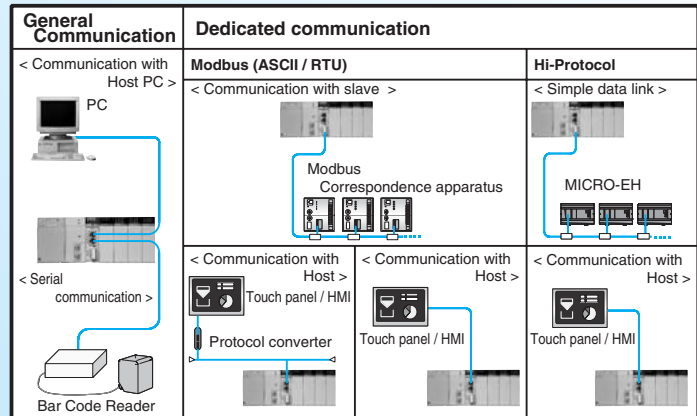

General Specifications

Item	Specification
Interface	EH-SIO RS-232C × 1 RS-232C/422/485 × 1
Communication mode	Half-duplex
Communication speed(bps)	300/ 600/ 1200/ 2400/ 48200/ 9600/ 19200/ 38400/ 57600
Maximum communication data	Maximum 1024 byte
Communication protocol	Non-protocol Modbus ASCII Modbus RTU Hi-Protocol(*)
Remarks	Simple data link by Hi-Protocol

(*) For Touch panel/HMI (LADDER EDITOR cannot be used)
EH-SIO is supported by EH-CPU 516/548

PROFIBUS® Master/Slave Module

System configuration



EH-RMP



EH-IOCP

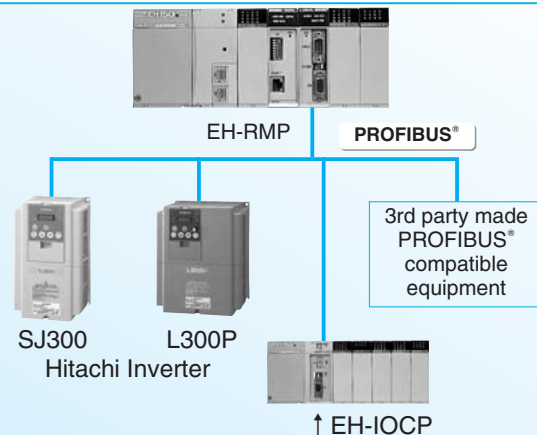

General Specifications

Item	Specification	
	EH-RMP	EH-IOCP
Current consumption	5 V DC, 600 mA	
Weight	Approximately 0.13 kg (0.29 lb.)	
Mounted slot position	Only slot 0 to 2 on basic base, Max. two times / CPU	Approximately 0.16 kg (0.35 lb.) CPU Slot

Performance specifications

Item	Specification	
	EH-RMP	
Number of installed units	2 units / CPU (can only be installed in slots 0 to 2)	
Number of supported slave units	Maximum of 124 units. However, a repeater is required to connect 32 or more units.	
Number of output words	256 words	
Number of input words	256 words	
Baud rate: Segment length	9.6 kbps	1,200 m
	19.2 kbps	1,200 m
	45.45 kbps	1,200 m
	93.75 kbps	1,200 m
	187.5 kbps	1,000 m
	500 kbps	400 m
	1,500 kbps	200 m
	3 Mbps	100 m
Self-diagnostics	System ROM / RAM check Watchdog timer	
	GSD file File name: Hita1004.gsd Please contact Hitachi sales office.	

Note 1 : EH-RMP is supported by EH-CPU316A/516/548.
2 : Please prepare the configuration software for set-up.

Item	Specification	
	EH-IOCP	
Number of installed I/O modules	16 units / EH-IOCP (use the EH-IOCH2 to install 9 or more units.)	
Node address setting range	1 to 99	
Input/output capacity	208 words	
Data update time	5 ms	
Baud rate: Segment length	9.6 kbps	1,200 m
	19.2 kbps	1,200 m
	93.75 kbps	1,200 m
	187.5 kbps	1,000 m
	500 kbps	400 m
	1,500 kbps	200 m
	3 Mbps	100 m
	6 Mbps	100 m
Self-diagnostics	System ROM / RAM check Watchdog timer	
	GSD file File name: Hita049.gsd Please contact our sales department.	

Supported I/O List

The I/O modules that are supported by the EH-IOCP are as follows:

Type	Input size (word)	Output size (word)
EH-XD8	1	0
EH-XD16		
EH-XDL16		
EH-XA16		
EH-XAH16		
EH-XD32	2	0
EH-XD32E		
EH-XDL32E		
EH-XD64		
EH-PT4	4	0
EH-AX44	8	0
EH-AX8V		
EH-AX8H		
EH-AX8I		

Type	Input size (word)	Output size (word)
EH-AX8IO	8	0
EH-AXH8M		
EH-TC8		
EH-YT8		
EH-YT16		
EH-YTP8	0	1
EH-YTP16		
EH-YTP16S		
EH-YS4		
EH-YS16		
EH-YR8B	0	1
EH-YR12		
EH-YR16		

Type	Input size (word)	Output size (word)
EH-YT32	0	2
EH-YTP32		
EH-YT32E		
EH-YTP32E		
EH-YT64	0	4
EH-YTP64		
EH-AY22		
EH-AY4V		
EH-AY4H	0	8
EH-AY4I		
EH-AYH8M		
EH-POS		
EH-POS4	4	4
EH-CU	5	3
EH-CUE		

•PROFIBUS is a registered trademark of Profibus Nutzer Organization

Ethernet™ Module

● System configuration

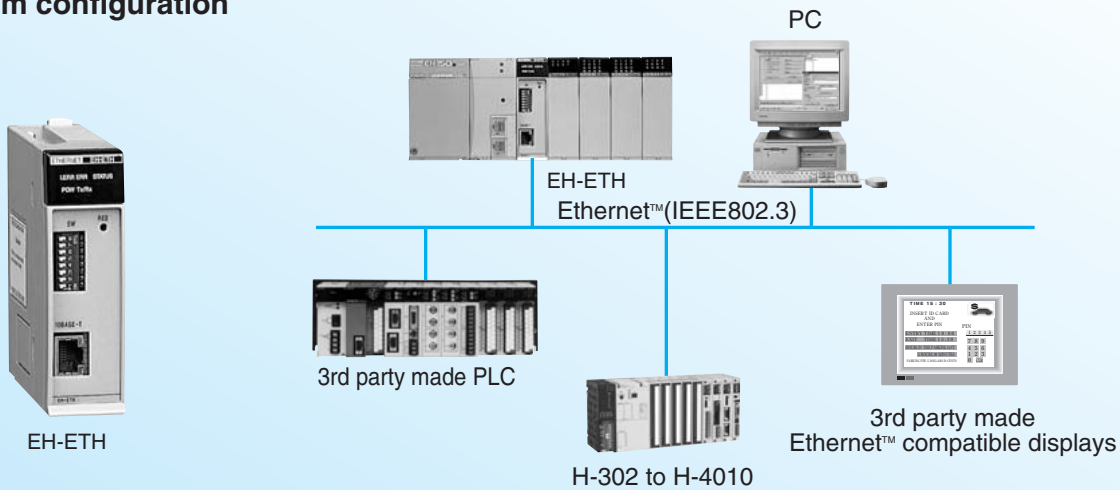

General Specifications

Item	Specification
Internal current consumption	5 V DC, 260 mA
Weight	0.15 kg (0.33 lb.)
Mounted slot position	Only slot 0 to 2 on basic base, Max. two times / CPU

Performance Specifications

Item	Specification	
Transfer specification	Ethernet standard	IEEE802.3 standard
	Transfer modulation method	Base band
	Medium access method	CSMA / CD
	Transfer speed	10 Mbps
	Maximum segment length	100 (m)
ASR connection	Number of simultaneous connections: Maximum 6 Transmission data: Maximum 1,454 bytes/try	
Task code communication	Number of simultaneous connections: Maximum 4	

Functional Specifications

Item	Specification
Setup function	<ul style="list-style-type: none"> ●Select the setup mode by using a DIP switch, and perform initial settings such as the IP address, transmission operation specification, and transmission/reception area specification using a general-purpose Web browser. ●The IP address can also be set by programming with a ladder program.
Auto Sending / Receiving function, event transmission function	<ul style="list-style-type: none"> ●Data can be transmitted and received periodically by specifying an internal output signal in a table format. ●Data can be transmitted and received by signal variation (event) in a ladder program.
Task code communication	<ul style="list-style-type: none"> ●Either TCP / IP or UDP / IP can be specified. ●H series task code communication can be performed.
Test function	<ul style="list-style-type: none"> ●Internal loop and external loop check functions are supported. ●One-to-one transmission / reception test function is supported.

Note : EH-ETH is supported by EH-CPU316A/516/548.

●Ethernet is a trademark of Xerox Corporation.

CPU Link Module (Coaxial cable)

System configuration

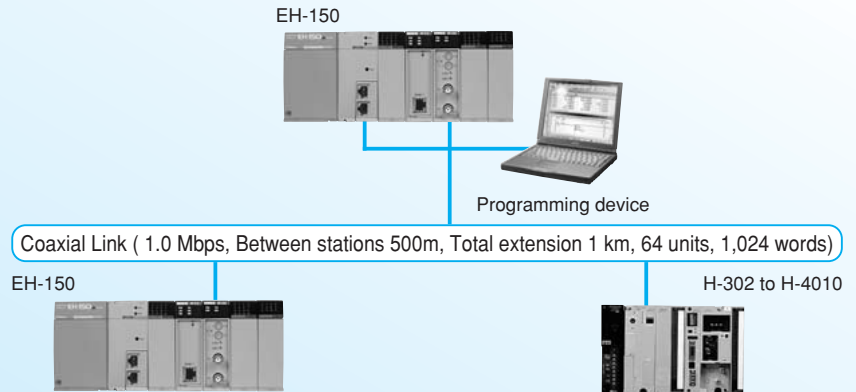

Specifications

Type	Item	Specification
Functional specification	Number of connected Link module	EH-LNK
	Number of mounted units	Max. 64 units / 1 loop
	Number of Link points	Max. 2 units / 1 CPU (2 loops / 1 CPU)
	Data delivery system	1,024 words / 1 loop (2,048 words / 2 loops) ^{*1}
	Send / Receive distinction on data area allocation	Common data area system
	Designation of Station No.	Parameter setting from peripheral device
	Communication speed	0 to 63 ; designated by rotary switch
	Transfer method	1.0 Mbps
	Communication method	Half - duplex serial transfer, frame synchronization
	Modulation method	Token passing
	Refresh time	Base band
	Error check	At the time of transfer of 1,024 words with 64 stations connected -- Approx. 390ms ^{*2}
	Self - diagnosis	CRC, overrun check, time out, open circuit, parameter error (dual designation of station No., overlapped Link area, etc.)
Transfer path specification	Transfer path form	System ROM / RAM check, watchdog timer check, transfer loop back check
	Cable length	Between stations
		Total extension
	Error station processing	Loop type
	Recommended cable	Max. 500m
Recommended connector	Max. 1,000m	
Internal Current consumption		Bypass system
		5D2V with shield or equivalent
		413631-1 (made by AMP) or equivalent
		5V DC Approximately. 550 mA

*1: No retentive area.

*2: This could be more in case peripheral devices access to CPU via link network.

*3: EH-LNK is supported by EH-CPU316A/516/548.

CPU Link Module (Optical cable)

System configuration

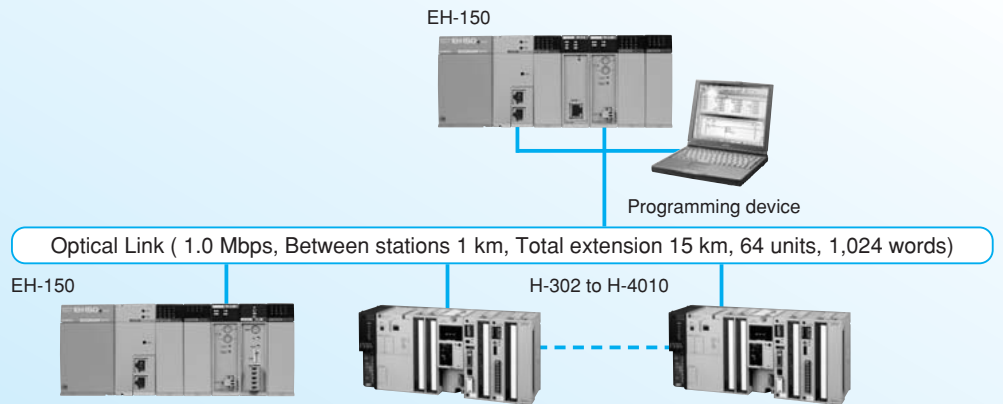

Specifications

Type	Item	Specification
Functional specification	Number of connected Link module	EH-OLNK
	Number of mounted units	Max. 64 units / 1 loop
	Number of Link points	Max. 2 units / 1 CPU (2 loops / 1 CPU)
	Data delivery system	1,024 words / 1 loop (2,048 words / 2 loops) ^{*1}
	Send / Receive distinction on data area allocation	Common data area system
	Designation of Station No.	Parameter setting from peripheral device
	Communication speed	0 to 63 ; designated by rotary switch
	Transfer method	1.0 Mbps
	Communication method	Half - duplex serial transfer, frame synchronization
	Modulation method	Token passing
	Refresh time	Base band
	Error check	In case of 1,024 words data and 64 stations connected -- Approx. 390ms ^{*2}
	Self - diagnosis	CRC, overrun check, time out, open circuit, parameter error (dual designation of station No., overlapped Link area, etc.)
Transfer path specification	Transfer path form	System ROM / RAM check, watchdog timer check, transfer loop back check
	Cable length	Between stations
		Total extension
	Error station processing	Loop type
	Recommended Cable and connector	Max. 1,000m
Internal Current consumption	Max. 15,000m	
		Bypass system (In case of supply a 5VDC from the outside.)
		CA7103-(1)M-(2)L(3)1 Hitachi Information&Communication Engineering, Ltd. (1) Cable length, (2)Cable type, (3) Core number
		5V DC Approximately. 550 mA

*1: No retentive area.

*2: This could be more in case peripheral devices access to CPU via link network.

*3: EH-OLNK is supported by EH-CPU316A/516/548

Programming Tools

LADDER EDITOR for Windows® (HLW-PC3E : For Windows® 95/98/NT® 4.0/2000/XP)

LADDER EDITOR for Windows®, which can be used with all H/EH series PLCs, realizes comfortable project management, thanks to its user-friendly features based on the distinctive functions of the Windows® operating system, such as icons, menu bar, and mouse operation.

Such operations as cut, copy, paste, and save can be done in the same way as on other Windows® based software.

Execution of various commands and input of ladder symbols can be easily performed using a mouse.

The features of LADDER EDITOR for Windows® help users program efficiently.

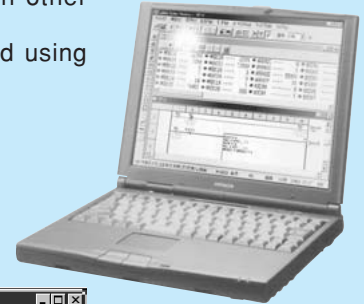

Menu bar

Almost all the commands required to operate LADDER EDITOR for Windows® can be selected from the pull-down menu. No command input from the keyboard is necessary.

Tool bar

Icons are prepared for such commands that are often used as open, save, cut, paste, etc. Just click to execute a command.

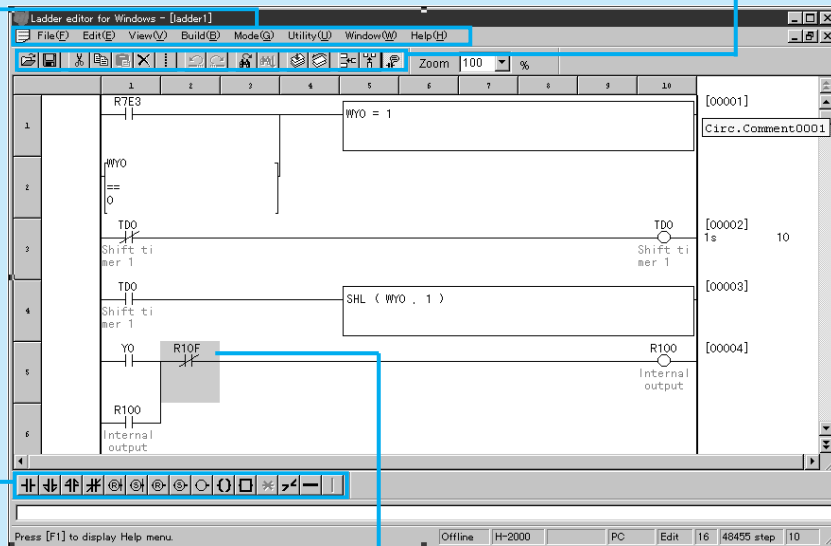

Symbol bar

Ladder symbols can be input by selecting one from the symbol bar and entering the necessary information, such as I/O number.

The circuit being edited is distinguished from the others by a different color. The color can be customized during editing and monitoring.

Pro-H

Pro-H is the universally usable 32-bit programming software for all Hitachi H/EH series PLCs.

- Standard according to IEC 61131-3
- Additional special instructions for H/EH series PLCs.
- 5 program editors(LD,IL,FBD,SFC, and ST)
- System requirements: Windows® 95/98/NT® 4.0

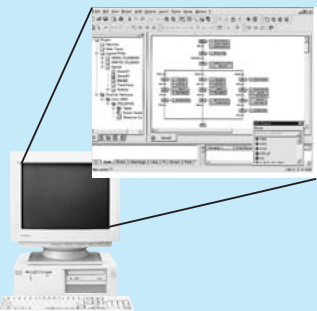

Ladder Diagram : (LD)

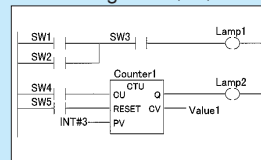

Instruction List : (IL)

```
LD R1
JMP RESET
LD PRESS_1
ST MAX_PRESS
RESET: LD 0
ST A_X43
```

Function Block Diagram : (FBD)

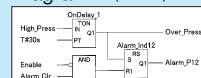

Sequential Function Chart : (SFC)

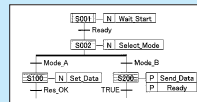

Structured Text : (ST)

```
IF SPEED1 > 100 THEN
  Flow_Rate := 50 * OffFact_A1;
ELSE
  Flow_Rate := 100;
Struam := ON;
ENDIF;
```

●LADDER EDITOR DOS version (HL-AT3E) is also available.

Programmer

Command language programmer



PGM-CHH

●Windows is a registered trademark of Microsoft Corp. in the U.S. and other countries.

Connection with Peripheral Devices

When connecting peripheral equipment, please use the cable(s) shown below.
Be sure to set the mode switch of the CPU module as desired before using.
(Please see the manuals for the setting.)

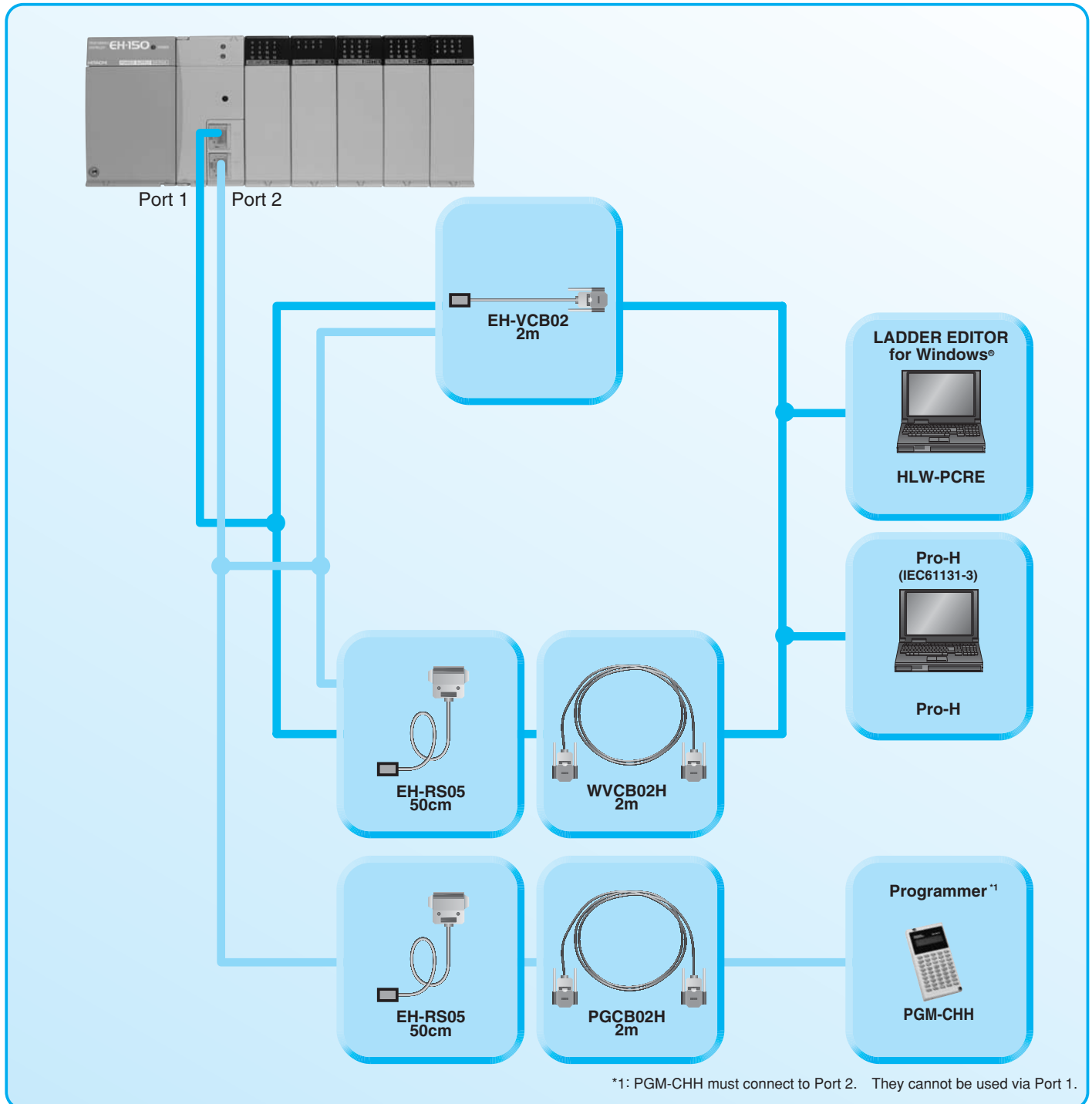

●Windows is a registered trademark of Microsoft Corp. in the U.S. and other countries.

Components List

Item	Model name	Specification	I/O assignment symbol	Remarks	
CPU module	EH-CPU104A	512 I/O points maximum *1, 4k steps (Cannot be expanded)	—		
	EH-CPU208A	1,024 I/O points maximum *1, 8k steps, Clock function, Modem control function	—		
	EH-CPU316A	1,024 I/O points maximum *1, 16k steps, Clock function, Modem control function, RS-422/485 communication support, PID command, Floating point operation support	—		
	EH-CPU516	2,112 I/O points maximum *1, 16k steps, Clock function, Modem control function, RS-422/485 communication support, PID command, Floating point operation support, 2 expansion bases	—		
	EH-CPU548	3,520 I/O points maximum *1, 48k steps, Clock function, Modem control function, RS-422/485 communication support, PID command, Floating point operation support, 4 expansion bases	—		
Memory board	EH-MEMP	Program capacity: 48k steps	—	Insert in to CPU module	
	EH-MEMD	Program capacity 16 k steps, Data capacity 384 k words	—		
Power supply module	EH-PSA	Input 100 to 240 V AC, Output 5 V DC 3.8 A, 24 V DC 0.4 A	—		
	EH-PSD	Input 21.6 to 26.4 V DC, Output 5 V DC 3.8 A	—		
Base unit	EH-BS3A	3 I/O modules can be installed	—	Basic base and expansion base are the same product.	
	EH-BS5A	5 I/O modules can be installed	—		
	EH-BS6A	6 I/O modules can be installed	—		
	EH-BS8A	8 I/O modules can be installed	—		
	EH-BS11A	11 I/O modules can be installed	—		
Input module	EH-XD8	8 points, 24 V DC input, Removable terminal block	X16		
	EH-XD16	16 points, 24 V DC input, Removable terminal block	X16		
	EH-XDL16	16 points, 24 V DC input Removable terminal block (Input lag 16ms)	X16		
	EH-XD32	32 points, 24 V DC input, Connector	X32		
	EH-XD32E	32 points, 24 V DC input, Spring type terminal	X32		
	EH-XDL32E	32 points, 24 V DC input, Spring type terminal (Input lag 16ms)	X32		
	EH-XD64	64 points, 24 V DC input, Connector	X64		
	EH-XA16	16 points, 100 to 120 V AC input, Removable terminal block	X16		
	EH-XAH16	16 points, 200 to 240 V AC input, Removable terminal block	X16		
	Output module	EH-YT8	8 points, Transistor output 12/24 V DC, Removable terminal block (sink type)	Y16	
		EH-YTP8	8 points, Transistor output 12/24 V DC, Removable terminal block (source type)	Y16	
EH-YR8B		8 points, Relay output, 100/240 V AC, 24 V DC, Removable terminal block	Y16		
EH-YR12		12 points, Relay output, 100/240 V AC, 24 V DC, Removable terminal block	Y16		
EH-YR16		16 points, Relay output, 100/240V AC, 24 V DC, Removable terminal block	Y16		
EH-YT16		16 points, Transistor output 12/24 V DC, Removable terminal block (sink type)	Y16		
EH-YTP16		16 points, Transistor output 12/24 V DC, Removable terminal block (source type)	Y16		
EH-YTP16S		16 points, Transistor output 12/24 V DC with short circuit protection, Removable terminal block (source type)	Y16		
EH-YT32		32 points, Transistor output, 12/24 V DC, Connector (sink type)	Y32		
EH-YTP32		32 points, Transistor output, 12/24 V DC, Connector (source type)	Y32		
EH-YT32E		32 points, Transistor output, 12/24 V DC, Spring type terminal (Sink type logic)	Y32		
EH-YTP32E		32 points, Transistor output, 12/24 V DC, Spring type terminal (Source type logic)	Y32	With short-circuit protection function	
EH-YT64		64 points, Transistor output, 12/24 V DC with short circuit protection, Connector (sink type)	Y64		
EH-YTP64		64 points, Transistor output, 12/24 V DC with short circuit protection, Connector (source type)	Y64		
EH-YS4		4 points, Triac output , 100/240 V AC, Removable terminal block	Y16		
EH-YS16		16 points, Triac output output, 100/240 V AC, Removable terminal block	Y16		
Analog input module	EH-AX44	12-bit analog input, Current 4-20 mA, Voltage 0-10 V,4ch each	WX8W		
	EH-AX8V	12-bit analog input, Voltage 0-10 V,8ch	WX8W		
	EH-AX8H	12-bit analog input, Voltage -10 to 10 V,8ch	WX8W		
	EH-AX8I	12-bit analog input, Current 4-20mA, 8ch	WX8W		
	EH-AX8IO	12-bit analog input, Current 0-22mA, 8ch	WX8W		
	EH-AXH8M	14-bit analog input, Current 0-22 mA/4-22 mA, Voltage -10 to 10 V/0-10 V,8ch	WX8W		
	EH-PT4	Signed 15-bit, Pt 100 ohms/Pt 1000 ohms, 4ch	WX4W		
	EH-TC8	Signed 15-bit, Thermo-couple (K,E,J,T,B,R,S,N) 8ch	WX8W		
	EH-AY22	12-bit analog output, Current 4-20 mA, Voltage 0-10 V,2ch each	WY8W		
	EH-AY4V	12-bit analog output, Voltage 0-10 V,4ch	WY8W		
EH-AY4H	12-bit analog output, Voltage -10 to 10 V,4ch	WY8W			
EH-AY2H	12-bit analog output, Voltage -10 to 10V, 2ch	WY8W			
EH-AY4I	12-bit analog output, Current 4-20mA	WY8W			
EH-AYH8M	14-bit analog output, Current 0-22 mA/4-22 mA, voltage 0-10 V,8ch	WY8W			
I/O controller	EH-IOCH2	I/O control module (Maximum 4 expansion bases, EH-CPU104 is not expandable.)	—		
Dummy module	EH-DUM	Module for open slots	Empty 16		
Counter module	EH-CU	High speed counter input, Maximum frequency of 100 kHz, 2 channels, 1/2-phase switchable, 4-point open collector output	FUN0		
	EH-CUE	High speed counter input, Maximum frequency of 100 kHz, 1 channel, 1/2-phase switchable, 2-point open collector output	FUN0		
Positioning module	EH-POS	1-axis positioning module	4W/4W		
	EH-POS4	4-axes positioning module	4W/4W	*2	
Communication module	EH-LNK	Coaxial CPU Link Module	LINK		
	EH-OLNK	Optical CPU Link Module	LINK	*3	
	EH-ETH	Ethernet module IEEE802.3 standard, 10 BASE-T	COMM		
	EH-SIO	Serial Communication Module (RS-232C, RS-422/485)	4W/4W	*4	
	EH-RMD	DeviceNet master module 256- word input, 256-word output, Up to 2 units can be installed per CPU Remote master module 1024 points (IN+OUT), Up to 4 units can be installed per CPU	LINK/REMOTE2	*3	
	EH-IOCD	DeviceNet slave module, 256-word input and 256- word output	—		
	EH-RMP	PROFIBUS master module 256- word input, 256-word output, Up to 2 units can be installed per CPU	LINK	*3	
EH-IOCP	PROFIBUS slave module, 209-word input and 209- word output	—			

*1: When 64 points I/O module is used *2: Supported by EH-CPU316A/516/548

*3: Supported by EH-CPU316A/516/548 in slot 0 to 7 (EH-BS5A/8A/11A) *4: Supported by EH-CPU516/548
EH-BS11A is supported by EH-CPU516/548.

Item	Model name	Specification	Remarks
Command language programmer	PGM-CHH	Command language programmer	
Programming software	HLW-PCRE	Ladder diagram/Command language editor (English version) LADDER EDITOR (for Windows® 95/98/NT® 4.0/2000/XP)	
	Pro-H	IEC61131-3 standard programming software, 5 Program editors (LD, IL, FBD, SFC, ST)	
	EH-RMDCFGE	DeviceNet Master configuration Software (Supported by Windows98/2000/ME/XP)	

Note: MS-DOS, Windows® 95/98/2000/XP and Windows NT®4.0 are registered of Microsoft Corporation in the United States.

Item	Model name	Specification	Remarks
Cable for connecting basic base to I/O controller	EH-CB05A	Length:0.5m (1.64 ft.) (Between Base unit and EH-IOCH) (for 2 or 4 expansion bases)	
	EH-CB10A	Length:1m (3.28 ft.) (Between Base unit and EH-IOCH) (for 2 or 4 expansion bases)	
	EH-CB20A	Length:2m (6.56 ft.) (Between Base unit and EH-IOCH) (for 2 or 4 expansion bases)	
I/O connector cable for EH-POS	EH-POC10	Length: 1m (3.28 ft.)	
	EH-POC20	Length: 2m (6.56 ft.)	
	EH-POC50	Length: 5m (16.4 ft.)	
Conversion cable for connecting peripheral devices	EH-RS05	Adapter cable for WVCB02H (0.5m 19.69 in.)	
For portable graphic programmer, command language programmer	PGCB02H	Length: 2 m (6.56 ft.), between CPU and programmer	
Peripheral devices	WVCB02H	Connection with a personal computer, EH-RS05 is required. (2m (6.56 ft.))	*5
	EH-VCB02	Direct connection between EH-150 and a personal computer (2m (6.56 ft.))	*5

*5: EH-VCB02 and WVCB02H are cables for LADDER EDITOR for Windows®.

Save wiring equipment

Item	Model name	Specification	Remarks
Terminal block	HPX7DS-40V6	Terminal for 32 / 64 points I/O module	
Cable for terminal block	EH-CBM01W	Length: 1m, Both edges connector.	
	EH-CBM03W	Length: 3m, Both edges connector.	
	EH-CBM05W	Length: 5m, Both edges connector.	
	EH-CBM10W	Length: 10m, Both edges connector.	
	EH-CBM01	Length: 1m, One edge connector.	
	EH-CBM03	Length: 1m, One edge connector.	
	EH-CBM05	Length: 1m, One edge connector.	
	EH-CBM10	Length: 1m, One edge connector.	

Form	Usage	Remarks
LIBAT-H	Lithium battery	The battery is used in common with the H series.
EH-LCN	L-type connector for the turn of coaxial connector. (for coaxial type CPU link module.)	

•Windows is a registered trademark of Microsoft Corp. in the U.S. and other countries.

General Specifications

Item	Specification
Power voltage	AC receiving power 100/110/120 V AC (50/60Hz) , 200/220/240 V AC (50/60Hz)
	DC receiving power 24 V DC
Power voltage fluctuation range	85 to 264 V AC wide range
	21.6 to 26.4 V DC
Allowable instantaneous power failure	85 to 100 VAC: for a momentary power failure of less than 10 ms, operation continues 100 to 264 VAC: for a momentary power failure of less than 20 ms, operation continues
Operating ambient temperature	0 to 55°C (Storage ambient temperature -10 to 75°C)
Operating ambient humidity	20 to 90% RH (no condensation) (Storage ambient humidity 10 to 90% RH (no condensation))
Vibration resistance	Conforming to IEC (EN) 61131-2 (147m/s ² , 3times in each 3directions X, Y, Z)
Noise resistance	○Noise voltage 1,500 Vpp Noise pulse width 100 ns, 1 μs (Noise created by the noise simulator is applied across the power supply module's input terminals. This is determined by this company's measuring methods.) ○Based on NEMA ICS3-304 (with the exception of input module) ○Static noise: 3,000 V at metal exposed area
Insulation resistance	20 M Ω or more between the AC external terminal and case ground (FE) terminal (based on 500 V DC mega)
Dielectric withstand voltage	1,500 V AC for 1 minute between the AC external terminal and case ground (FE) terminal
Grounding	Class D grounding (ground with power supply module)
Usage environment	No corrosive gases, no excessive dust
Structure	Open, wall-mount type
Cooling	Natural air cooling

Dimensions

[Unit: mm]

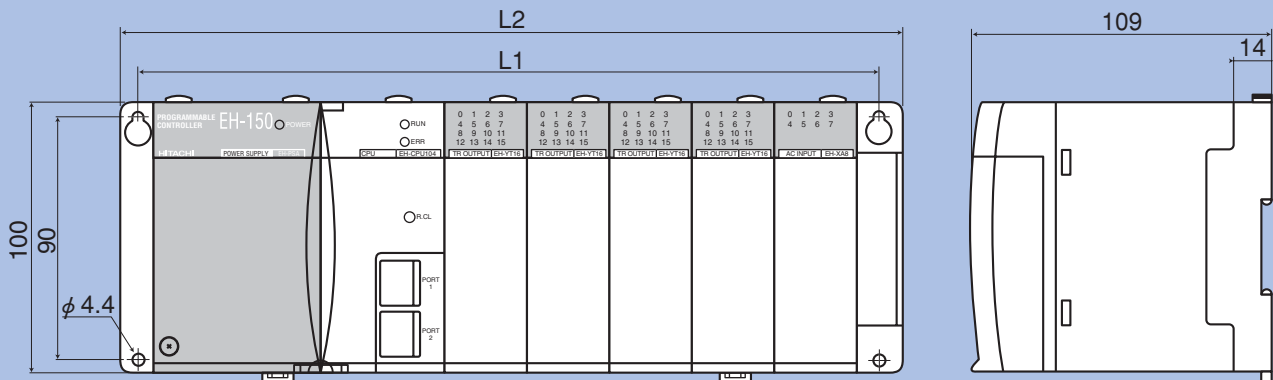

Base	EH-BS11A	EH-BS8A	EH-BS6A	EH-BS5A	EH-BS3A
Number of I/O modules	11	8	6	5	3
L1	447	357	297	267	207
L2	462.5	372.5	312.5	282.5	222.5
Weight	0.4kg (0.88 lb.)	0.36kg (0.79 lb.)	0.31kg (0.65 lb.)	0.28kg (0.62 lb.)	0.22kg (0.49 lb.)

EH-BS11A is supported by EH-CPU516/548.

Network



Germany

Hitachi Europe GmbH

Industrial Components & Equipment Group
Am Seestern 18
D-40547 Düsseldorf
TEL: (49) (211) 5283-0
FAX: (49) (211) 5283-649
<http://www.hitachi-eu.com/>
<http://www.hitachi-ds.com/>

U.S.A

Hitachi America, Ltd.

Industrial Systems Division
50 Prospect Avenue
Tarrytown, NY 10591-4698
TEL: (1) (914) 631-0600
FAX: (1) (914) 631-3672
<http://www.hitachi.us/>

China

Hitachi East Asia Limited

4th Floor, North Tower
World Finance Centre, Harbour City
Canton Road, Tsim Sha Tsui, Kowloon
Hong Kong
TEL: (852) 2735-9218
FAX: (852) 2375-3192

Hitachi (China) Ltd.

18th Floor, Beijing Fortune Building,
5 Dong San Huan Bei Lu,
Chao Yang District, Beijing 100004, China
TEL: (86) (10) 6590-8111
FAX: (86) (10) 6590-8110
<http://www.hitachi.com.cn/>

Hitachi (Shanghai) Trading Co., Ltd.

1408, Rui Jin Building,
No.205, Maoming Road(S)
Shanghai, 200020
TEL: (86) (21) 6472-1002
FAX: (86) (21) 6472-4990
<http://www.hitachi.com.cn/>

Hitachi East Asia Limited Taipei Branch

3rd Floor, Hung Kuo Building No.167
Tun-Hwa North Road, Taipei (105), Taiwan
TEL: (886) (2) 2718-8777
FAX: (886) (2) 2718-8180

Singapore

Hitachi Asia Ltd.

Power & Industrial Systems Group
24 Jurong Port Road
#03-05, Office Block
CWT Distripark
Singapore 619097
TEL: (65) (6271)-6086
FAX: (65) (6278)-4521
<http://www.hitachi.com.sg/>

Thailand

Hitachi Asia (Thailand) Co., Ltd.

18th Floor, Ramaland Building
952 Rama IV Road, Bangrak
Bangkok 10500
TEL: (66) (2) 632-9292
FAX: (66) (2) 632-9299
<http://www.hitachi.co.th/>

Australia

Hitachi Australia Pty Ltd.

Level 3, 82 Waterloo Road
NORTH RYDE NSW 2113
Australia
TEL: (61) (2) 9888-4100
FAX: (61) (2) 9888-4188
<http://www.hitachi.com.au/>

Information in this brochure is subject to change without notice.

Hitachi Industrial Equipment Systems Co., Ltd.

For further information, please contact your nearest sales representative.



ISO14001
JQA-EM5428



ISO 9001
JQA-1000

The EH-150 series PLCs are produced at the factory registered under the ISO 14001 standard for environmental management system and the ISO 9001 standard for quality management system.