

User Manual

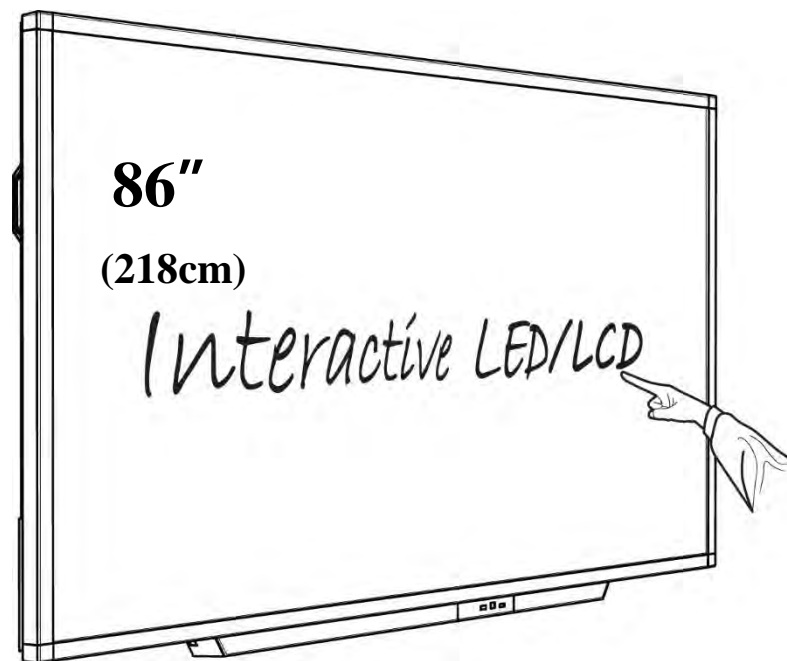

Model: HILU-86101

86" Interactive LED/LCD

Contents





1. Important safety Instruction	3
1.1 Safety precautions	
1.2 Maintenance	
2. Introduction	8
3. Product Description	9
3.1 Front View	
3.2 Rear View	
3.3 Connection	
4. Remote Controller	12
5. OSD menu Description	13
6. Product Specifications	24
7. Product Dimensions	26
8. Troubleshooting	27
8.1 Product Self-Diagnosis	
8.2 Before Requesting Service	

1. Important Safety instructions

[SAFETY WARNING]

- To reduce the risk of fire or electric shock, do not expose this product to rain or moisture.
- To prevent injury, this product must be securely attached to the floor/wall in accordance with the installation instructions.
- To reduce the risk of electric shock, do not remove the back cover
- Refer servicing to qualified service personnel if needed.

► Icons used in this manual

	CAUTION RISK OF ELECTRIC SHOCK. DO NOT OPEN.			The lightning flash and arrowhead within the triangle indicates that there is dangerous voltage inside the product.
				The exclamation point within the triangle indicates that there are important instructions accompanying the product.

[WARNING] means,

If you ignore the warning message, you may be seriously injured or there is a possibility of accident or death.

[CAUTION] means,

If you ignore the caution message, you may be slightly injured or the product may be damaged.

[NOTE] means,

The note helps you understand and use the product safely. Please read the note carefully before using the product.

► When moving the product, please grab the handles behind and the bottom of the product as shown below picture.

- The product must keep horizontal and upright position when moving.
- Do not hold the corner of the product when you grab the bottom of the product.

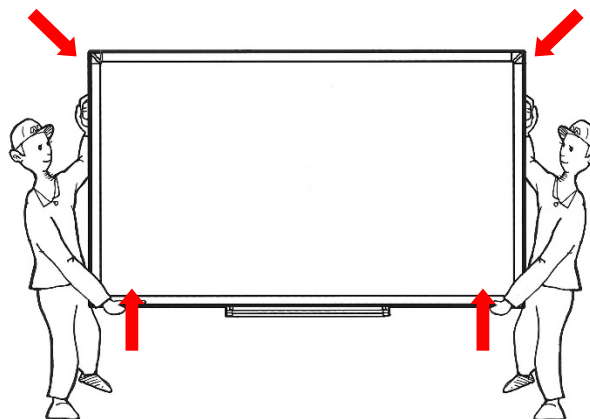

1.1 SAFETY PRECAUTION

Note) The color and design may differ by each model and the product specification are subject to change without notice for performance enhancement.

1.1.1 Power

[Warning]

- Do not use damaged power cord, plug nor loose socket. It may cause electric shock or fire.
- Do not connect multiple devices into a single socket. It may cause fire due to overheating.
- Do not touch with wet hands when remove or plug the power cord to avoid electric shock.
- Insert the power plug into socket firmly. It may cause fire when the connections are unstable.
- Connect the power cord to a grounded wall socket. There is risk of electric shock or injury.
- Do not bend nor pull the power cord and place heavy objects over the power cord. It may occur cord damage and this may result in fire.
- Please clean only with dry cloth when the plug pin or socket are dusty. It may cause fire.

[Caution]

- Do not unplug the power plug while the product is operating. It may damage the product due to electric shock.
- Only a power cord specified by product manufacturer are recommended.
Do not use the power cord from other devices. It may cause electric shock or fire.
- Hold the plug itself when unplugging the power plug from the wall socket. If not, there is risk of electric shock or fire.
- Before moving or installing this product, be sure to turn off the power and disconnect the power cord. To turn this product off completely, you must pull the power plug out of the wall socket. Consequently, the power plug must be easily and readily accessible at all times.

1.1.2 Installation

[Warning]

- Do not install near any heat sources such as radiators, or other devices that produce heat. It may cause electric shock or fire.
- When mounting a product on the wall, make sure not to install the product by hanging the power and signal cables on the back of it.
- Consult with your local dealer or specialized engineer to mount the product on the wall, and use the screws and wall mounts that meet the VESA standard. Any damages or injuries by misuse or using an improper accessory are not covered by the warranty.
- Leave a 10 cm (4 inches) (minimum) space from the wall for proper ventilation. If not, it may cause fire.
- Keep the packing anti-moisture material or vinyl packing out of the reach of children. Anti-moisture material is harmful if swallowed. If swallowed by mistake, force the patient to vomit and visit the nearest hospital. Additionally, vinyl packing can cause suffocation. Keep it out of the reach of children.

- Please note that the product must be supported on proper stands or installed according to the manufacturer's recommendations. The product that are inappropriately situated on unstable shelves, inclined planes, or vibrating places, etc., may fall over, resulting in injury.
- To reduce the risk of fire or electrical shock, do not expose this product to rain, moisture or other liquids or dust. It may cause electric shock or fire.
- Keep the product away from direct sunlight.
- Keep the product out of the reach of children and install on the stable and flat place. NEVER allow children to climb on or play on the product or the furniture and stands on which the product is placed.

[Caution]

- Do not allow an impact shock or any objects to fall into the product, and do not drop anything onto the screen.
- Make sure the product is turned off, unplugged, and all cables have been removed. It may take more than 4 people to lift and carry.

Do not press or put stress on the front panel of the product.

- If the product is installed in a place where the operating conditions considerably, a serious quality problem may occur due to the surrounding environment. In this case, install the product only after consulting our dealer about the matter. (Places exposed to microscopic dust, chemicals, too high or low temperature, high humidity, airports or stations where the product is continuously used.)

1.1.3 Cleaning

[Warning]

- Before cleaning the product, unplug the power cord and wipe gently with a soft cloth to prevent scratching.
- Do not spray water or other liquids directly on the product as electric shock may occur.

[Caution]

- Do not push, rub, or hit the surface with your fingernail or a sharp object, as this may result in scratches on the screen and image distortions.
- Do not use any chemicals, such as waxes, benzene, alcohol, thinners, insecticides, air fresheners, or lubricants, as these may damage the screen's finish and cause discoloration.
- Do not spray liquid onto the surface. If water enters the product, it may result in fire, electric shock, or malfunction.

1.1.4 General Usage

[Warning]

- To reduce the risk of electric shock, do not open the cover or back. No user serviceable parts inside. Refer to qualified service personnel.
- Before moving or lifting the product, disconnect the power cord and all cables.
- Route the cords and cables connected to the product so that they cannot be tripped over, pulled or grabbed.

- Do not stick metal objects or any other conductive material into the power cord. Do not touch the end of the power cord while it is plugged in. It may result in fire, electric shock.
- Unplug this product during lightning storms or when unused for long periods of time.
- Do not block any ventilation openings. Install in accordance with the manufacturer's instructions.
- To reduce the risk of fire or electrical shock, do not expose this product to rain, moisture or other liquids. Do not touch the product with wet hands. Do not install this product near flammable objects such as gasoline or candles, or expose to direct air conditioning.
- NEVER allow children to climb on or play on the product or the furniture on which it is placed. It may cause severe injury to children.
- Use only with a cart, stand, tripod, bracket, or table specified by the manufacturer, or sold with the product. When a cart is used, be careful when moving the cart/product combination to avoid injury from tip-over.
- Install where it cannot be pushed, pulled over or knocked down.
- It is recommended to move the product in the box or packing material that originally came in.
- When holding the product, the screen should face away from you to avoid damage.

[Caution]

- If a fixed image displays on the screen for a long period of time, it will be imprinted and become a permanent disfigurement on the screen. This is image burn or burn-in and not covered by the warranty.
 - When watching the screen, take 5 to 15 minute breaks every hour. Viewing screen for a long period of time may cause fatigue or eye strain.
 - Take care not to touch the ventilation openings. When watching the screen for a long period, the ventilation openings may become hot. This does not affect the performance of the product or cause defects in the product.
 - Do not install this product on a wall if it could be exposed to oil or oil mist. This may damage the product and cause it to fall.
 - To install batteries in remote control, open the battery cover, replace batteries matching (+) and (-) ends to the label inside the compartment, and close the battery cover. Failure to match the correct polarities of the battery may cause the battery to burst or leak, resulting in fire, personal injury, or ambient pollution.
 - To prevent to swallow the small accessories for children, keep the accessories out of the reach of children.
- ※ The product must keep horizontal and upright position when moving. Hold the top and bottom of the frame firmly. Handles are only for the supporting purpose.
 - ※ When attaching the stand to the set, place the screen facing down on a cushioned table or flat surface to protect the screen from scratches by more than 2 people.
 - ※ Make sure that the screws are fastened tightly.
(If they are not fastened securely enough, it may tilt forward after being installed.)

1.2 MAINTENANCE

1.2.1 Cleaning

- When cleaning, unplug the power cord and wipe gently with a soft dry cloth to prevent scratching.
- Do not spray water or other liquids directly on the screen as electric shock may occur.
- Do not clean with chemicals such as alcohol, thinners, or benzene.

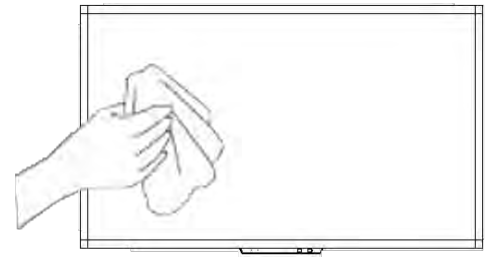

1.2.2 Installation

- Leave a 10 cm (4 inches) (minimum) space from the wall for proper ventilation.
- If not, it may cause fire or malfunction due to the high temperature product inside.

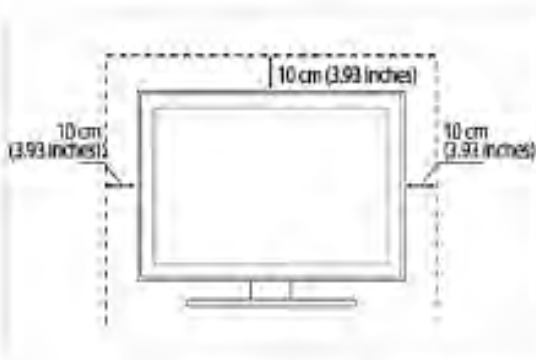

[When attaching the stand]

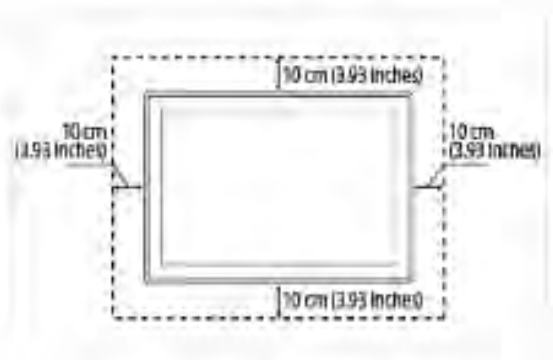

[When mounting on a wall]

1.2.3 Panel

- Avoid displaying a fixed image on the screen for a long period of time (2 or more hours for LCD) to prevent image burn. Recommend to power off or set the power saving mode or screen saver when not in use.
- Due to technological constraints of the Panel manufacturer, the images generated by this product may appear either brighter or darker than normal by appr. 1ppm (parts per million) pixel.

The number of sub-pixels of a panel by size: The number of Sub-Pixels = Max. Horizontal Resolution x Max. Vertical Resolution x 3.

For example, if the maximum resolution is 1920 x 1080, the number of sub-pixels is 1920 x 1080 x 3 = 6,220,800.

2. Introduction

- ▶ Check your product box for the following items. If there are any missing accessories, contact the local dealer where you purchased your product.

The illustrations in this manual may differ from the actual product and item.

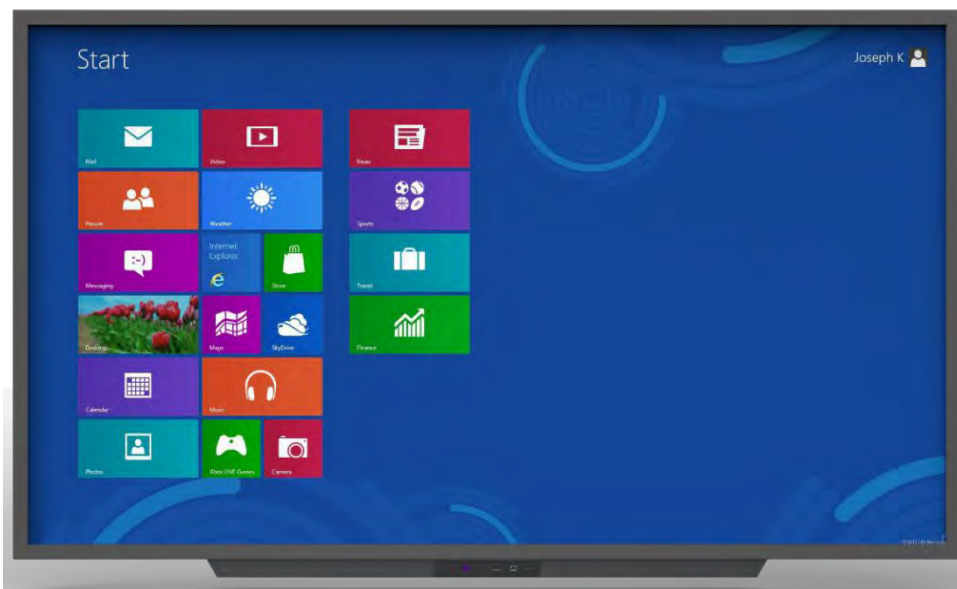

LCD/LED Display



User Manual



HDMI Cable



USB Cable(for TOUCH)



Power Cable

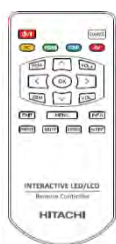

Remote Controller



Battery(CR-2025 x 1)



PEN x 2

Accessory

3. Product Description

3.1 FRONT VIEW

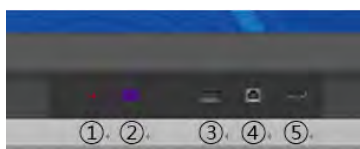
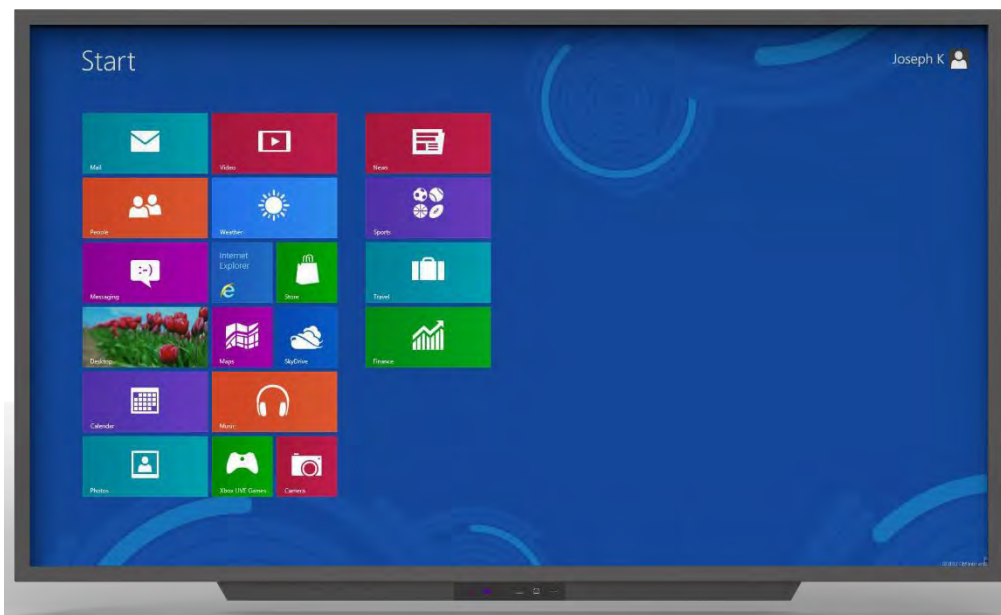

① Power LED ② IR RECEIVER ③ USB ④ USB for TOUCH ⑤ HDMI IN (Ver.1.4)

3.2 REAR VIEW





- Power: ON / OFF
- Menu: Display the main screen menu
- Source: Display Port, HDMI1, HDMI2, HDMI3, HDMI Front, HDMI OPS, PC, USB
- Vol +: Volume Up (Right)
- Vol -: Volume Down (Left)
- ▲: Move Up
- ▼: Move Down

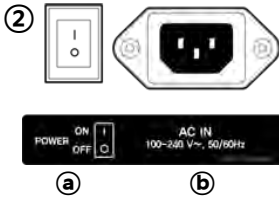

- (a) Power Switch : ON / OFF
- (c) HDMI OUT(FHD)
- (e) Display Port
- (g) VGA
- (i) Audio Line out
- (k) USB for UPDATE
- (m) USB for TOUCH

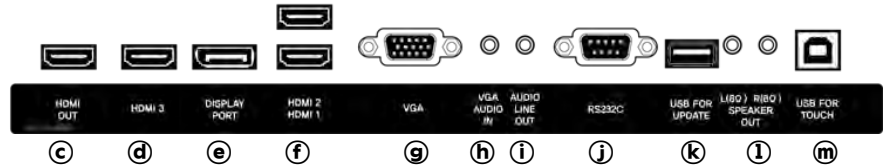

- (b) AC IN: 100V~ 240V, 50/60Hz
- (d) HDMI 3 Input (Ver.1.4)
- (f) HDMI 1, 2 Input (Ver.2.0)
- (h) VGA Audio In
- (j) RS-232C
- (l) Speaker output

③ When you need to install OPS PC.

There is a slot on ③ for OPS PC. When you need to install OPS, remove screws and existing cover first and screw up again after mounting OPS PC in the slot.

④ When you install Remote module

There is a slot on ④ for Remote module, When you need to install Remote module, remove screws and existing cover first and screw up again after mounting Remote module in the slot.

⑤ AC cord holder



* To prevent take Power cable out, please use cable holder if you need. SCREW (4x11)

3.3 CONNECTION

1) HDMI/Display Port Connection

To transmit digital video and audio signals from an external device to the screen, connect the HDMI/Display Port cables as shown in the following illustration.



- ① HDMI Output – Connect the other monitor to transmit video data
- ②, ③, ④ HDMI 1, 2, 3 Input – PC/ LAPTOP connect to the HDMI cable
- ⑤ DisplayPort Input – PC/ LAPTOP connect to the DisplayPort cable

2) VGA Connection

In case of transmission digital video signal from an external device to the screen, connect the external device and the product with the VGA cable and to transmit an audio signal, connect an audio cable in PC AUDIO IN port separately.

3) Speaker Connection

To utilize an optional external audio system instead of the built-in speaker, if you connect Ø3.5 stereo (L/R) cable in the port.

If it is connected to external speakers, internal speaker may not sound.

The connection is as below.

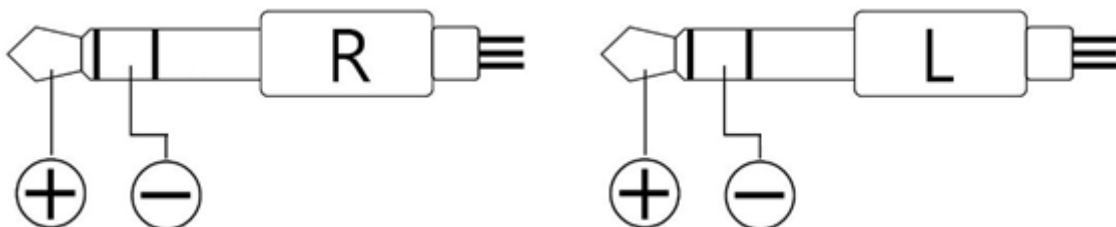

※ Note that when using OPS PC Connection

- 1) Do not connect touch sensor USB cable to the port.
(Touch sensor cable is already connected by internal OPS docking board.)
- 2) Power on LCD/LED Display, OPS turns on automatically.
- 3) Power off LCD/LED Display, OPS turns off automatically.

4. Remote Controller

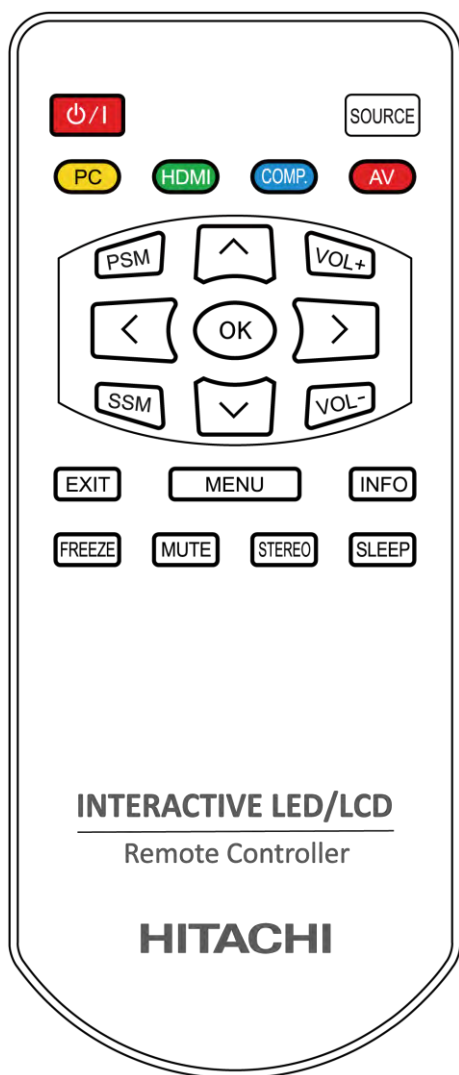

Key Name	Description
⏻/⏻	Power ON/OFF.
SOURCE	Activates OSD menu of input source selecting. Navigates input source.
PC	VGA
AV	AV.(N/A)
HDMI	DP, HDMI 1, HDMI 2, HDMI 3, OPS
PSM	Picture mode: Standard, Dynamic, Soft, User.
SSM	Sound mode: Standard, Flat, Music, Movie.
MENU	Activates main OSD menu.
EXIT	Escapes main OSD menu.
INFO	Displays input source information.
FREEZE	Videos are saved with pictures.
MUTE	Toggles sound status of speaker.
STEREO	Set the Audio L+R, Audio L, Audio R.
SLEEP	Set the sleep timer.
^	Navigates upper menu in main OSD menu. Navigates input source.
v	Navigates down menu in main OSD menu. Navigates input source
>	Navigates next menu in main OSD menu.
<	Navigates before menu in main OSD menu.

** How to insert battery.

Insert the battery into proper polarities

Battery model : (CR-2025 3V)

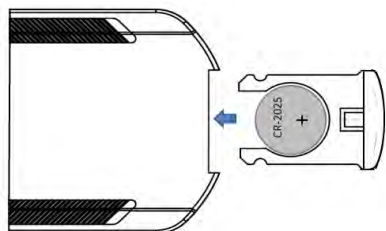

5. OSD Menu Description

5.1 Menu Overview

In this menu system, there are several ways to customize the menu settings provided. If you press the MENU button, only the first and second level of the menu system will appear on the monitor screen. The third level can be displayed by pressing SELECT.

1) To show and hide the menu:

Press the MENU button on the Remote Control to display the menu.

Press of the MENU button will take you back to monitor viewing.

2) To go to advance to the next menu:

Press OK on the Remote Control.

3) To go back to the previous menu:

Press MENU on the Remote Control.

4) Typical Menu Operation

- Press MENU button: The main menu will appear.
- Use to select the desired menu option (icon).
- While the desired menu option is selected, press OK to move to the second level.
- Press OK to move to the third level: Some menu options require additional steps.
- Press MENU to return to the previous menu.

PICTURE MENU

◆ Press the [MENU] Button. The OSD Main MENU will be shown.

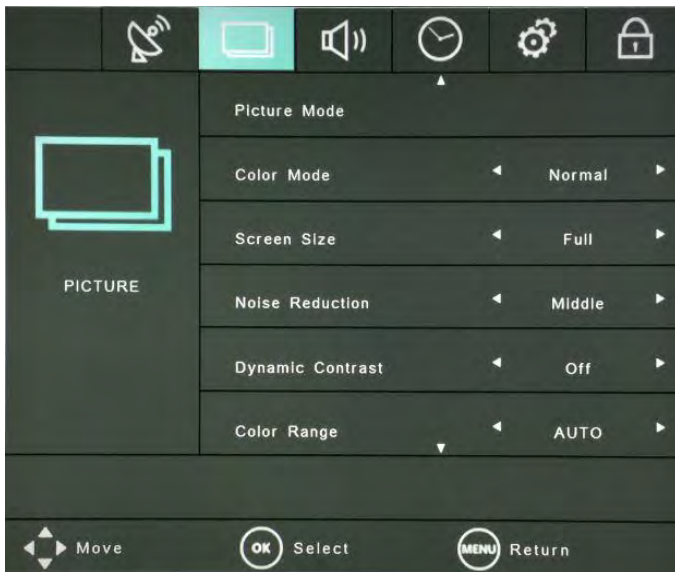

◆ PICTURE MENU

- 1) Go to Picture Menu by pressing Menu button on remote controller or OSD key
- 2) Set Picture Mode, Color Mode, Screen Size, Noise Reduction, Dynamic Contrast and Color Range in Picture Menu by pressing ◀/▶ icon

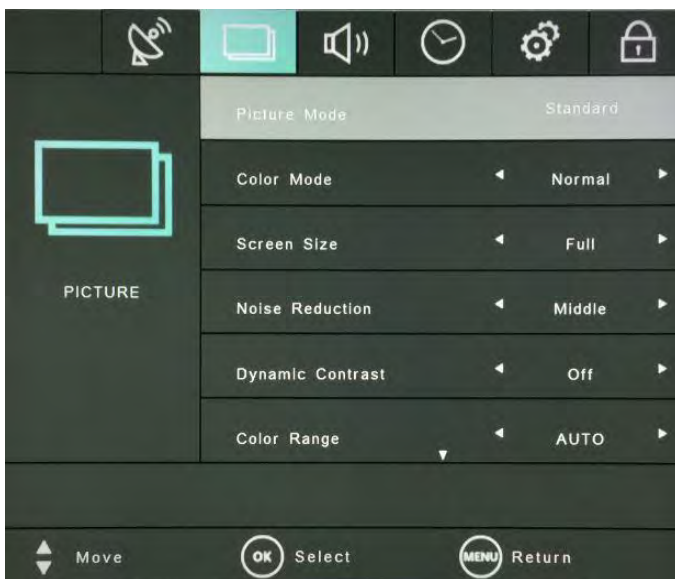

◆ Picture Mode

- 1) Go to Picture Mode by pressing ▲/▼ on the remote controller or OSD key.
- 2) Adjust Brightness, Contrast, Color, Tint and Sharpness with OK or SELECT button
- 3) User can use preprogrammed Standard, Movie and Soft or can make his own favorite setting

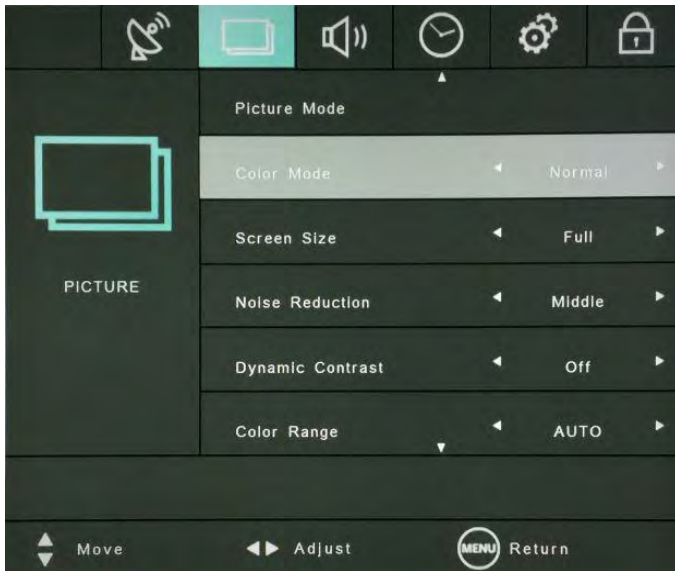

◆ Color Mode

- 1) Go to Color Mode by pressing ▲/▼ on the remote controller or OSD key.
- 2) Select Color Temperature (Normal/Warm/Cold) by pressing ◀/▶ icon

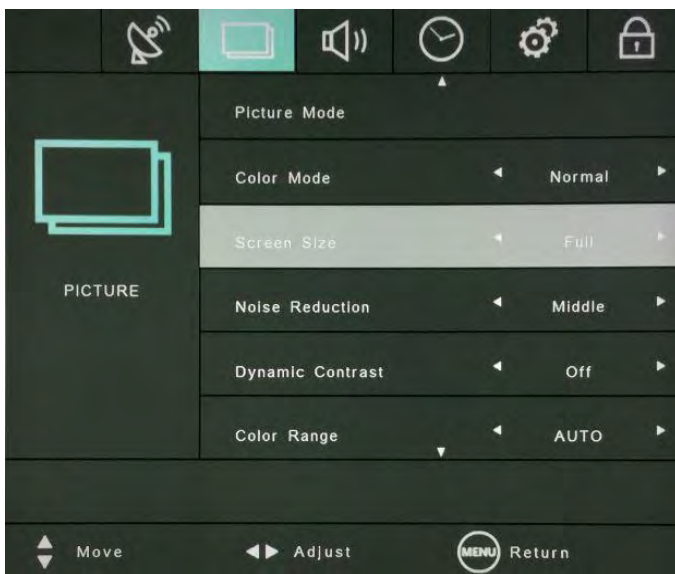

◆ Screen Size

- 1) Go to Screen Size by pressing ▲/▼ on the remote controller or OSD key.
- 2) Select ratio of screen by pressing ◀/▶ icon : Full, 1:1, Normal, Zoom and Cinema, Wide

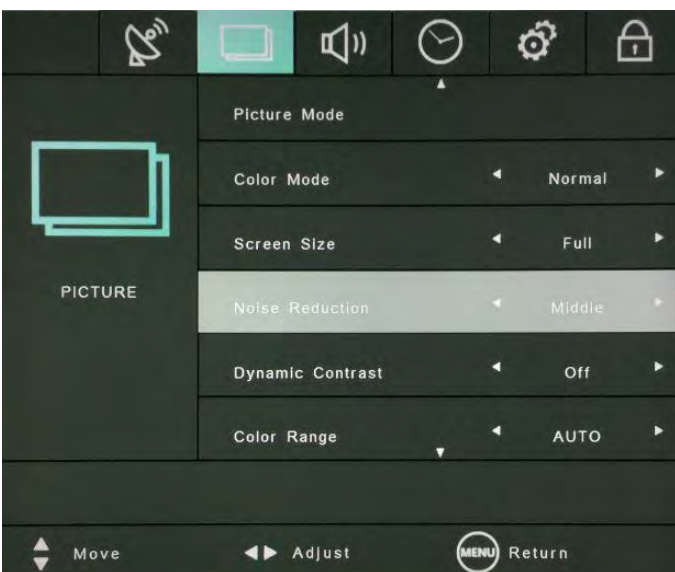

◆ Noise Reduction

- 1) Go to Noise Reduction by pressing ▲/▼ on the remote controller or OSD key.
- 2) Select Noise Reduction level by pressing ◀/▶ icon : Weak, Middle, Strong

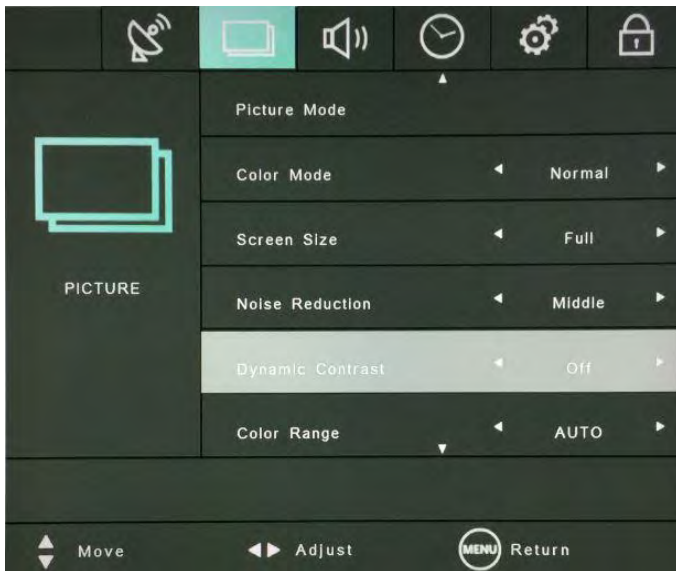

◆ Dynamic Contrast

- 1) Go to Dynamic Contrast by pressing ▲/▼ on the remote controller or OSD key.
- 2) Available in Full HD resolution below
- 3) Select On or Off to adjust contrast by pressing ◀/▶ icon

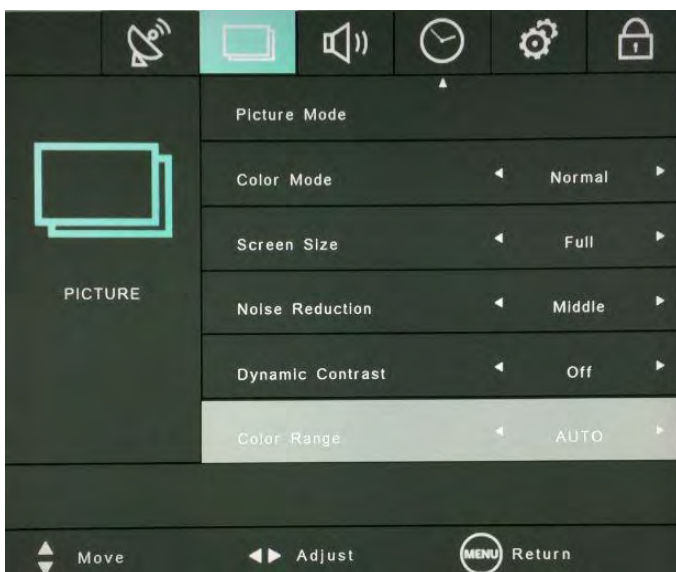

◆ Color Range

- 1) Go to Color Range by pressing ▲/▼ on the remote controller or OSD key.
- 2) Available in Full HD resolution below
- 2) Select color range by pressing ◀/▶ icon:
Auto, 16~235 for TV, 0~255 for PC

AUDIO MENU

- ◆ Press the [MENU] Button. The OSD Main MENU will show.



◆ AUDIO MENU

- 1) Go to Audio Menu by pressing Menu button on remote controller or OSD key
- 2) Set Sound Mode, Surround, Audio Only, Equalizer in Audio Menu by pressing ◀/▶ icon



◆ Sound Mode

- 1) Go to Sound Mode by pressing ▲/▼ on the remote controller or OSD key.
- 2) Adjust Bass, Treble and Balance with OK or SELECT button
- 3) User can use preprogrammed Standard, Music, Movie and Sports or can make his own favorite setting



◆ Surround

- 1) Go to Surround by pressing ▲/▼ on the remote controller or OSD key.
- 2) Turn on or off spatial impression, direction and reverberation of sound by pressing ◀/▶ icon.



◆ Equalizer Setting

- 1) Go to Equalizer Setting by pressing ▲/▼ on the remote controller or OSD key.
- 2) Adjust frequency characteristic by pressing ◀/▶ icon
- 3) User can use preprogrammed Rock, Pop and Jazz or can make his own favorite setting

TIME MENU

◆ Press the [MENU] Button. The OSD Main MENU will show.



◆ TIME MENU

- 1) Go to Time Menu by pressing Menu button on remote controller or OSD key
- 2) Set Sleep Timer, Time Format, Clock, Wake Up, No Signal Power Off by pressing ◀/▶ icon

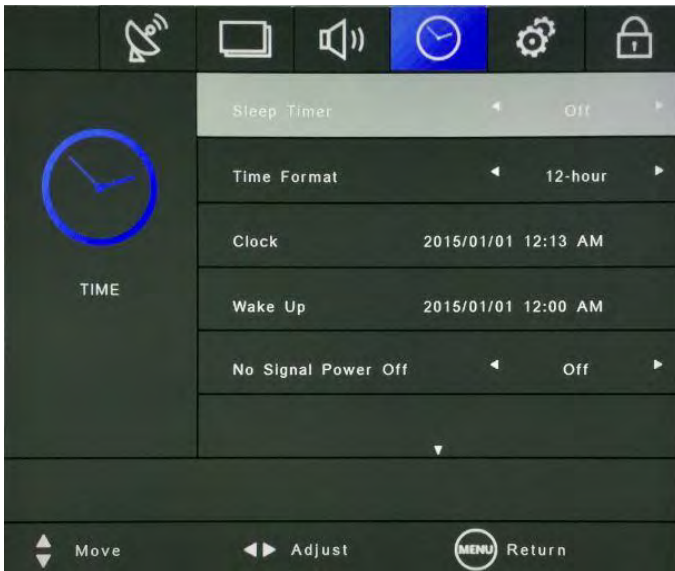

◆ Sleep Timer

- 1) Go to Sleep Timer by pressing ▲/▼ on the remote controller or OSD key.
- 2) Set timer by 5/10/15/30/60/90/120/180/240 minutes to turn off automatically with OK or SELECT button
- 3) Press Sleep Timer again on the remote controller or OSD key to cancel Sleep Timer

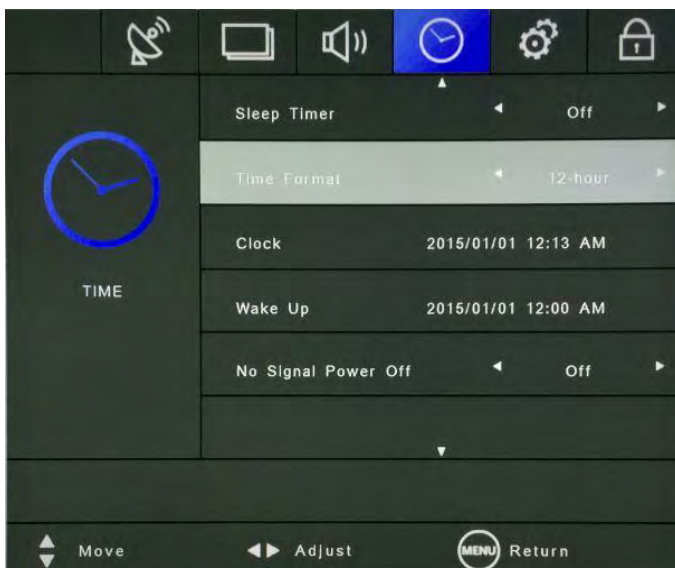

◆ Time Format

- 1) Adjust Time Format by pressing ◀/▶ icon : 12-Hour(AM,PM) or 24-Hour

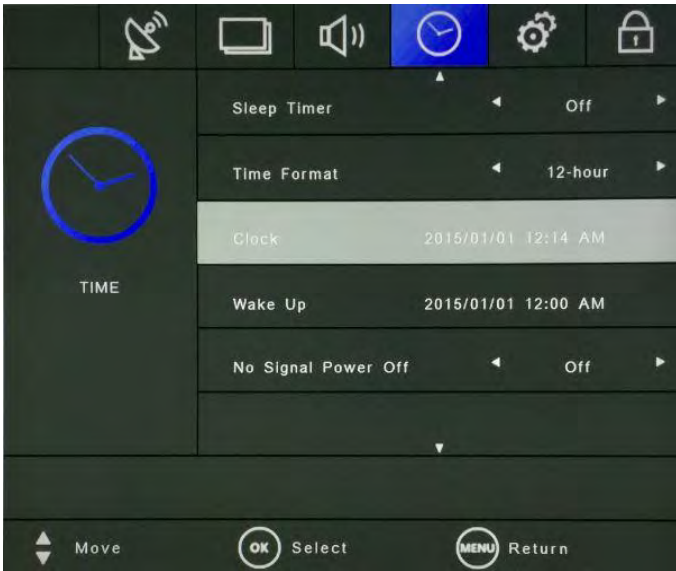

◆ Clock

- 1) Adjust Present Time by pressing ◀/▶ icon :
Year, Month, Day, Hour, Minute



◆ Wake Up

- 1) Set Wake Up Time by pressing ◀/▶ icon :
Year, Month, Day, Hour, Minute
- 2) It turns on automatically when it is Wake Up Time

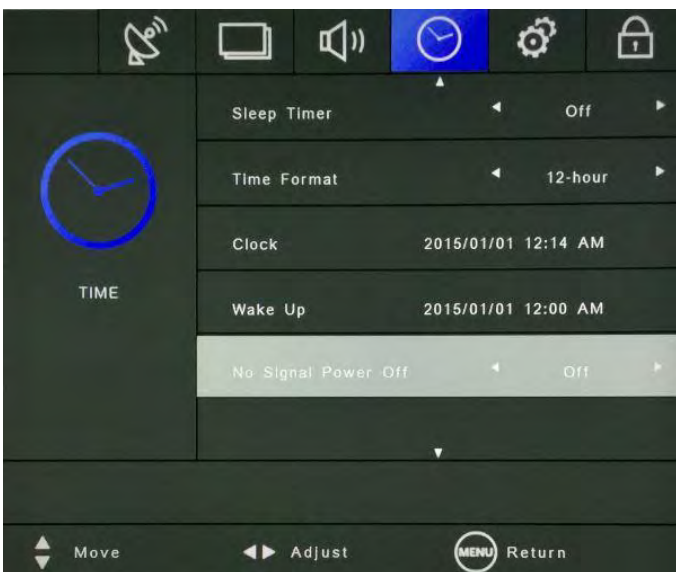

◆ No Signal Power Off

- 1) It turns off automatically when there is no video input data
- 2) Set closing time by pressing ◀/▶ icon :
1/3/5/10/15s

SETUP MENU

◆ Press the [MENU] Button. The OSD Main MENU will show.



◆ SETUP MENU

- 1) Go to SETUP Menu by pressing Menu button on remote controller or OSD key
- 2) Set Menu Language, Menu Transparency, OSD Time Out, All Reset, Blue Background, CEC, COM ID, HDMI Setting by pressing ◀/▶ icon

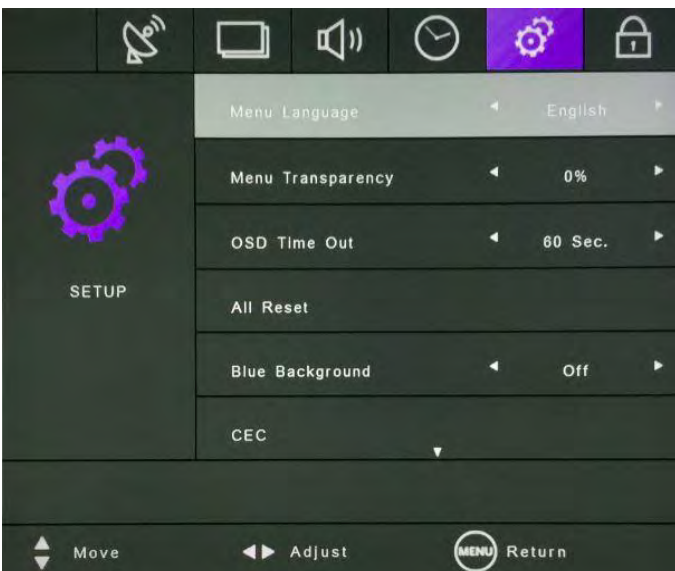

◆ Menu Language

- 1) Go to Menu Language by pressing ▲/▼ on OSD key.
- 2) Set Language by pressing ◀/▶ icon : English, Japanese



◆ Menu Transparency

- 1) Go to Menu Transparency by pressing ▲/▼ on OSD key.
- 2) Set transparency of OSD by pressing ◀/▶ icon : 0%/25%/50%/75%/100%

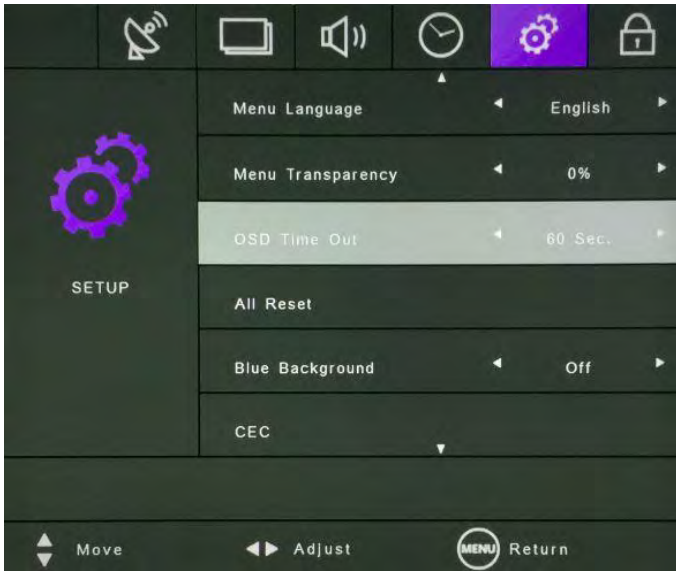

◆ OSD Time Out

- 1) Go to OSD Time Out by pressing ▲/▼ on OSD.
- 2) Set OSD Time Out by pressing ◀/▶ : 5/15/30/45/60 seconds
- 3) OSD disappears when it is OSD Time Out



◆ All Reset

- 1) Go to All Reset by pressing ▲/▼ on OSD key.
- 2) Press OK or SELECT button. Then, “Are you sure?” pops up.
- 3) Press ◀ not to do All Reset or press ▶ to default OSD settings.

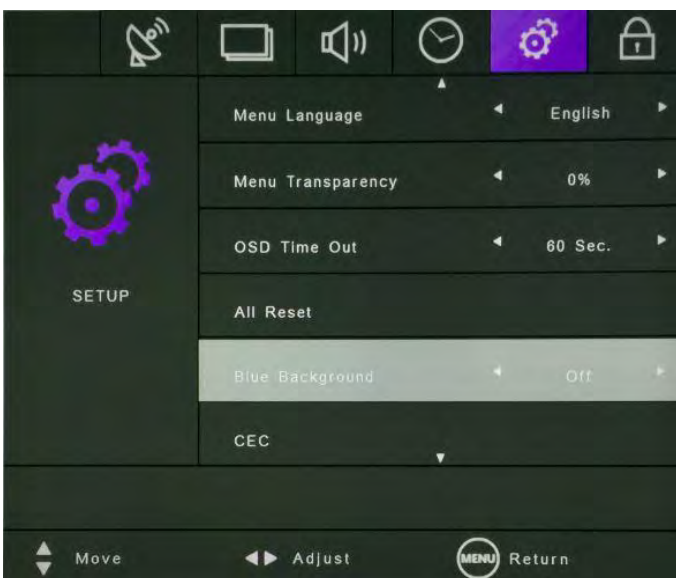

◆ Blue Background

- 1) Go to Blue Background by pressing ▲/▼ on OSD.
- 2) Turn on or off Blue Background by pressing ◀/▶
- 3) If there is no video data, blue background displays with On, while black background displays with Off

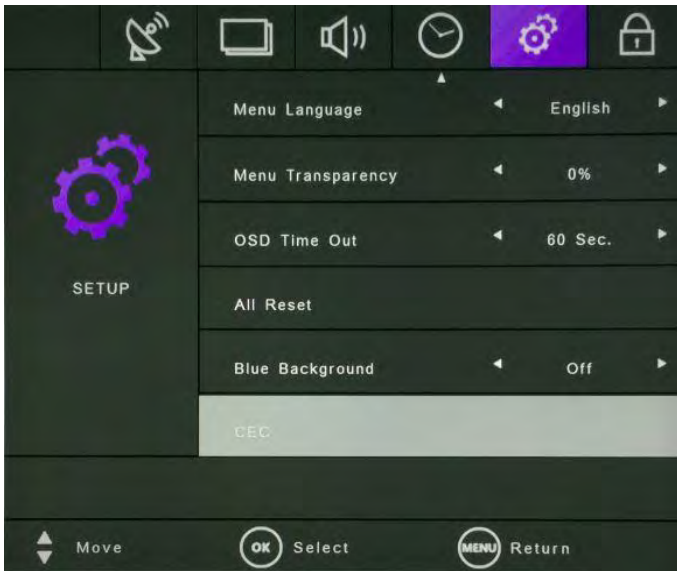

◆ CEC

- 1) Go to CEC by pressing ▲/▼ on remote controller or OSD
- 2) Press OK or SELECT button to perform CEC control
- 3) Then, it activate Device Auto Power Off, TV Auto Power On, Audio Receiver with TV source only



◆ COM ID

- 1) Go to COM ID by pressing ▲/▼ on remote controller or OSD
- 2) Assign command ID to connect other devices with RS232 by pressing ◀/▶



◆ HDMI Setting

- 1) Go to HDMI Setting by pressing ▲/▼ on remote controller or OSD
- 2) Press OK or SELECT button to set frame frequency (Hz) of HDMI source and EDID (HDMI ports 1/2/3/4, Front and OPS source).
- 3) EDID 1.4 : frame frequency 30Hz
EDID 2.0 : frame frequency 60Hz

LOCK MENU

◆ Press the [MENU] Button. The OSD Main MENU will show.

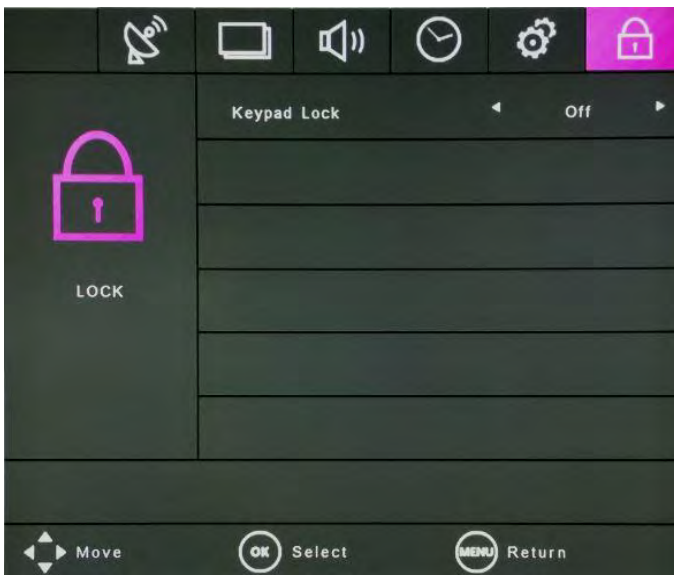

◆ Keypad Lock

- 1) Go to Lock Menu by pressing ▲/▼ on remote controller or OSD
- 2) Set Keypad Lock On or Off by pressing ◀/▶.

6. Product Specification

Note: Product design and features without prior notice may be changed.

Items	Specifications
Detection method	Infrared blocking
Touch tool / Response time	Hand or other solid object / <12ms
Supported OS	Windows 7 / 8 / 10 MAC(10.7 ~ 10.10 or higher version than 10.10)
Resolution(Pixel)	3,840 x 2,160
Front Glass	Tempered 4mm, AG
Overall dimensions(WxHxD)	1,971 X 1,197 x 109mm
VESA Mount	600 x 400 (mm), M8 Screw
Weight	92 kg

LED Panel Specifications

Items	Specifications
Active screen size (Diagonal)	85.60"/217.4(cm)
Display Colors	10bit(D), 10.7 Billion
Brightness	410 cd/m ²
Contrast Ratio	1200:1 (Typ.)
View Angle(Typ.)	H: 178° / V: 178° (CR>=10)

Ratings of Environment

Item / Model	Specifications
Storage Temperature	-20°C ~ +60°C
Operating Temperature	0°C ~ +40°C, 20% to 80% RH(no condensation)
Power Supply Voltage	AC100 ~ 240V, 50/60Hz
Standby	< 0.5W
Speaker	20W + 20W Stereo (8-ohms)
Power Consumption	Max. 333W

Input/output Description

Items		Specifications	
Video	Display Format	Full, 1:1, Normal, Zoom, Cinema, Wide	
	Picture Status Memory	4 Modes	
	Color Status Memory	3 Modes	
Sound	Output(RMS)	EQ Max. 20W X 2 Channels	
	Sound System	Stereo	
	Equalizer	7 Bands	
	Sound Status Memory	5 Modes	
	Balance	Yes	
Terminals	VGA	1 (D-SUB 15P)	
	PC-Audio	1 (Ø3.5 JACK)	
	HDMI In (Rear)	3 (HDMI 1,2 : Ver.2.0 / HDMI 3 : Ver.1.4)	
	HDMI Out (Rear)	1 (FHD)	
	Audio Line Out	1 (Ø3.5 JACK)	
	DisplayPort	1 (DP 1.4/HDCP2.2/DVI1.0 Compatible)	
	Speaker Out (L)	1 (Ø3.5 JACK)	
	Speaker Out (R)	1 (Ø3.5 JACK)	
	RS232C	1 (D-SUB 9P)	
	USB	1 ('B' Type, for Touch Sensor)	
	USB	1 ('A' Type, for Software Update)	
	LAN	10/100 Mbps(Auto detection), RJ-45 Connector	
	HDMI In (Front)	1 (Ver.1.4)	
	USB (Front)	1 ('B' Type, for Touch Sensor) , 1 ('A' Type, for Data Storage)	
Others	Clock	Yes	
	Sleep Timer / Auto Sleep	Yes	
	On Timer	Yes	
	Off Timer	Yes	
	Child Lock	Yes	
	Freeze Function	Yes	
Resolution	HDMI, DisplayPort	4Kx2K@(30Hz/60Hz),1080P(50/60Hz), 1080i, 720P(50Hz/60Hz), 576P(50Hz), 480P(60Hz) VESA TIMING : up to 1920x1080@60Hz	
	VGA	DOS	720*400(70Hz)
		VGA	640*480(60Hz/72Hz/75Hz)
		SVGA	800*600(56Hz/60Hz/72Hz/75Hz)
		XGA	1024*768(60Hz/70Hz/75Hz)
		SXGA	1280*1024(60Hz)
		WXGA	1280*768(60Hz/75Hz),1360*768(60Hz/75Hz)
		UXGA	1600*1200(60Hz)
FHD	1920*1080(60Hz)		

7. Product Dimensions

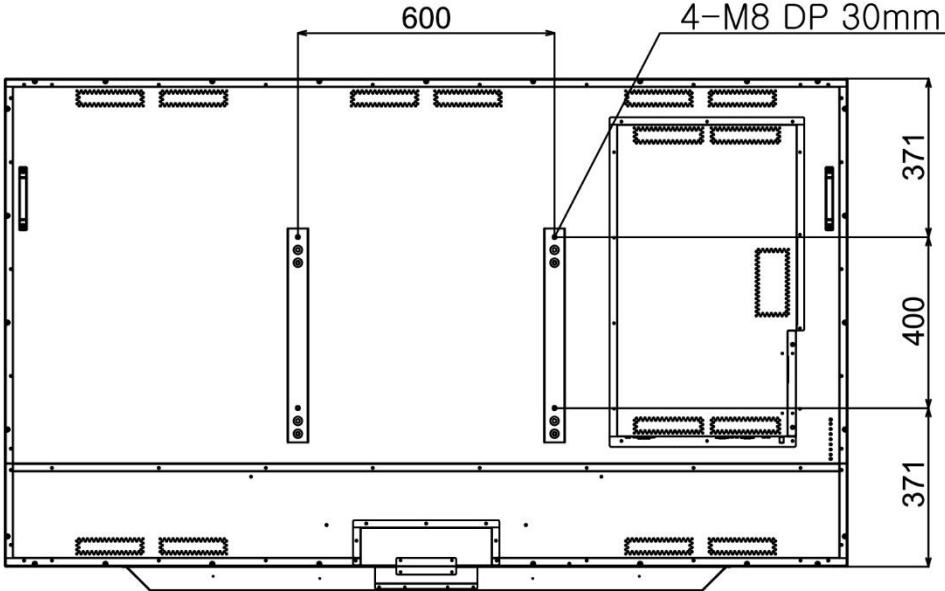
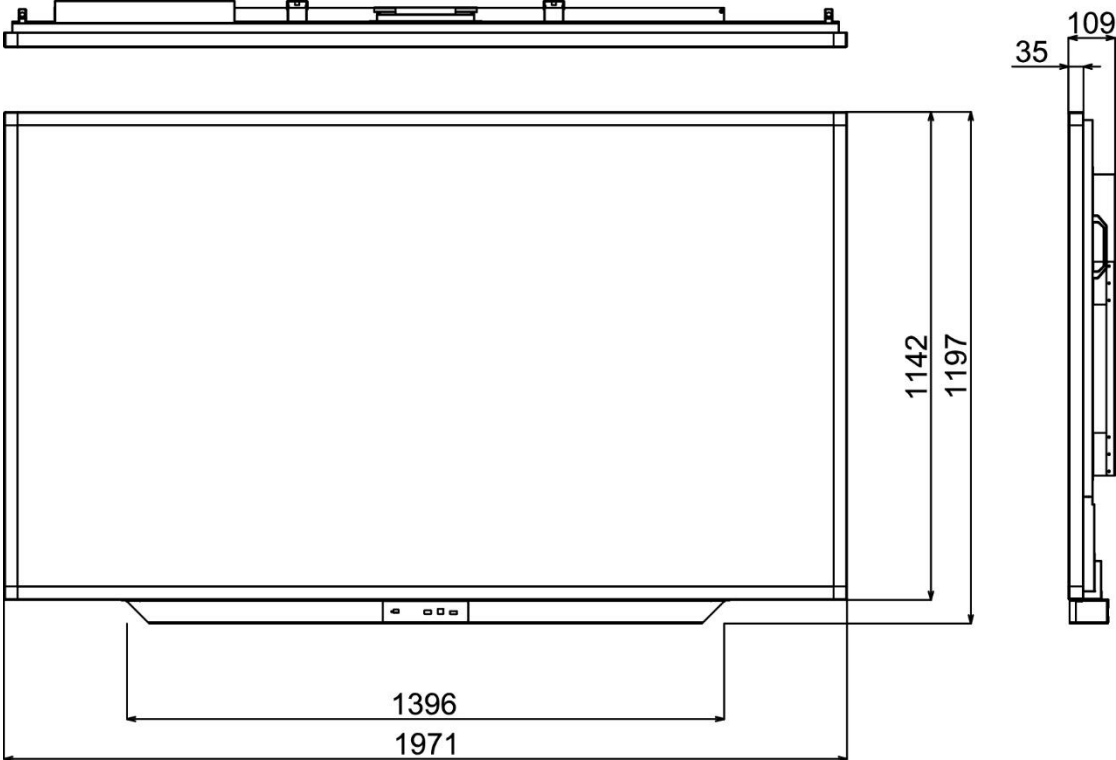

8. Troubleshooting

8-1 Product Self-Diagnosis

- You can check if the product is working properly using the Self-Diagnosis function.
- If a blank screen is displayed but the Power LED on even if the product and the PC are properly connected, perform the self-diagnosis function according to the procedures below.
 - 1) Turn the product and the PC off.
 - 2) Remove the any connected cables from the product.
 - 3) Turn the product on.
 - 4) If the product is working properly, the <No Signal>message appears.

In this case, if a blank screen is displayed again, make sure that there is no problem with the PC and the connection.

8-2. Before Requesting Service

- Please check the following before requesting After-Sales service and if the problem continues, please contact the local dealer where you purchased your product.

1) PROBLEMS RELATED TO SCREEN

- A. Screen is blank and power indicator is off.
 - » Ensure that the power cord is firmly connected and the monitor is on.
- B. "No Signal" Message.
 - » Check the maximum resolution and the frequency of the video adapter.
 - » Compare these values with the data in the Standard Signal Mode Table.
- C. Picture rolls vertically.
 - » Check if the signal cable is securely connected. Connect it again securely.
- D. Image is not clear. Picture is blurred.
 - » Run frequency tuning.
 - » Turn on again after removing all accessories. (Video extension cable, etc.)
 - » Set resolution and frequency to the recommended ranges.
- E. The image is too light or too dark.
 - » Adjust the <Brightness>and<Contrast>and<Backlight>.

2) PROBLEMS RELATED TO AUDIO

- A. No sound.
 - » Ensure that the audio cable is firmly connected to both the audio-in port on your monitor and the audio-out port on your sound card.
- B. The sound level is too low.
 - » Check the volume level. If the volume is still too low after turning the control to its maximum, check the volume control on the computer sound card or software program.

3) PROBLEMS RELATED TO REMOTE CONTROL

- A. The remote control buttons do not respond.
 - » Check the battery polarities (+/-).
 - » Check if the batteries have been exhausted.
 - » Check if the power is on.
 - » Check if the power cord is securely connected.
 - » Check if a special fluorescent or neon lamp is on in the vicinity.

