



32LD380TA



HITACHI

32" LCD Television

Model

32LD380TA

USER'S MANUAL

用戶手冊

用戶手冊

РУКОВОДСТВО ПОЛЬЗОВАТЕЛЯ

**READ THE INSTRUCTIONS INSIDE CAREFULLY.
KEEP THIS USER'S MANUAL FOR FUTURE REFERENCE.**

For future reference, record the serial number of your television.

SERIAL NO. _____

The serial number is located on the rear of the television.

**NOTE:**

The information in this manual is subject to change without notice. The manufacturer assumes no responsibility for any errors that may appear in this manual.

TRADEMARK ACKNOWLEDGEMENT

VGA and XGA are registered trademarks of International Business Machines Corporation.

VESA is a trademark of a nonprofit organization, Video Electronics Standard Association.

All brand or product names are trademarks or registered trademarks of their respective holders.

注：

本手册的内容在未经提示的情况下会有改动。制造商认为对可能出现于本手册中的错误不承担责任。

商标认可

VGA 和 XGA 是IBM公司的注册商标。

VESA 是非营利组织—视频电子标准协会的商标。

所有品牌或产品名称是其相应持有者的商标或注册商标。

註：

本手册的内容在未经提示的情况下会有改动。製造商認為對可能出現於本手冊中的錯誤不承擔責任。

商標認可

VGA 和 XGA 是IBM公司的註冊商標。

VESA 是非營利組織—視頻電子標準協會的商標。

所有品牌或產品名稱是其相應持有者的商標或註冊商標。

ВНИМАНИЕ:

Предоставленная в данном руководстве информация может быть изменена без предварительного уведомления. Производитель не несет никакой ответственности за какие бы то ни было ошибки, которые могут встретиться в данном руководстве.

ПОДТВЕРЖДЕНИЕ ПРАВ НА ТОРГОВЫЕ МАРКИ

VGA и XGA являются зарегистрированными торговыми марками International Business Machines Corporation.

VESA является торговой маркой некоммерческой организации Video Electronics Standard Association.

Все названия продуктов и марок являются торговыми марками или зарегистрированными торговыми марками, принадлежащими из законным обладателям.

USER'S MANUAL

Thank you very much for purchasing the HITACHI LCD Television. Before using your television, please carefully read the "SAFETY INSTRUCTIONS" and this "USER'S MANUAL" so you will know how to operate the television properly. Keep this manual in a safe place. You will find it useful in the future.

Notes on Installation Work:

This product is marketed assuming that it is installed by qualified personnel with enough skill and competence. Always have an installation specialist or your dealer install and set up the product. HITACHI cannot assume liabilities for damage caused by mistake in installation or mounting, misuse, modification or a natural disaster.

Note for Dealers:

After installation, be sure to deliver this manual to the customer and explain to the customer how to handle the product.



FEATURES

Important

Please read this User's Manual thoroughly, especially the Safety Instructions on Page 4 to 7. Mis-use may cause damage to your LCD television, which could shorten its lifespan, or cause injury to yourself. Should you encounter any difficulty in the set-up or operation of your television, firstly refer to the Troubleshooting guide at the rear of this manual. In the unlikely event of a problem occurring with your LCD television, switch off at the mains sockets, pull out the plugs, and contact your dealer immediately.

CAUTION

Under no circumstances remove the rear cover of your LCD television. Never guess or take any chances with electrical equipment of any kind - it is better to be safe than sorry!

Software Notice

It is prohibited for the end user of this product to copy, reverse engineer or reverse compile the software included therein, save to the extent permitted by law.

LCD Television

After the LCD television has been on for any length of time, you will notice that the screen becomes warm. Please note that this is normal. Sometimes the screen might have some tiny bright or dark spots. Please note that this is normal.

CAUTION

To prevent scratches or damages to the LCD screen, do not knock or rub the surface with sharp or hard objects. Clean the screen with a soft cloth moistened with warm water and dry with a soft cloth. A mild soap may be used if the screen is extremely dirty. Do not use harsh or abrasive cleaners!

CAUTION

Use a soft cloth to clean the cabinet and control panel of the television. When excessively soiled dilute a neutral detergent in water, wet and wring out the soft cloth and afterward wipe with a dry soft cloth. Never use acid/alkaline detergent, alcoholic detergent, abrasive cleaner, powder soap, OA cleaner, car wax, glass cleaner, etc. especially because they would cause discoloration, scratches or cracks.

Large-screen, high-definition LCD display panel

The 32-inch color LCD display panel, with a resolution of 1366(H) x 768(V) pixels, creates a high-definition, large-screen (aspect ratio : 16:9) and low-profile flat display. Free from electromagnetic interferences from geomagnetic sources and ambient power lines, the panel produces high-quality display images free from color misconvergence and display distortion.

Easy-to-use remote control and on screen display system

The remote control included eases the work of setting display controls. Further, the on-screen display system, displays the status of signal reception and display control settings in an easy-to-view fashion.

Connecting to an Audio Visual Device

- Three composite/S terminals¹, three composite terminals², two component terminals² and a HDMI terminal have been added. A composite video output terminal is also provided as a monitoring output.

¹ A composite/S terminal = A side input

² If two composite terminal and two component terminal are used at the same time, the component terminal would govern.

- A wide range of devices can also be connected besides personal computers.



CONTENTS

FEATURES 2

SAFETY INSTRUCTIONS 4

ABOUT LCD PANEL 8

Location of controls 9

Remote Control 10

Antenna connection 12

Connections to other equipment 13

Quick guide for MENU-operation 18

Selecting the video input source 18

On-screen Language Selection 19

Teletext Language Selection 19

Automatic station presetting with
the built-in Tuner 20

Change the order of stored channel 21

Manual TV station presetting 22

Basic Operation 23

Timer functions 24

Stereo reception with the built-in tuner 25

Bass, Treble and Balance 27

Perfect volume 27

Turning off the built-in speakers 28

Using the WOW™ surround sound feature 28

Brightness, Contrast, Color and Sharpness 29

DNR 29

Selecting the color temperature 30

Film mode 30

Picture format 31

Scrolling the PANORAMIC-Wide picture 32

Back light 33

Using the panel lock feature 34

PC-Setting 35

Selecting the HDMI audio input source 36

Teletext 37

Conceal stored channels 39

Color system adjusting 40

Troubleshooting table 41

Specifications 41

ENGLISH

Notes about This Manual

- The information in this manual is subject to change without notice.
- While meticulous care has been taken in the preparation of this manual, you are requested to notify your dealer or us should you have any comments, views or questions about our product.
- Fully understand the prerequisites to using the product, such as hardware and software specifications and constraints, in using the product. We are not held liable for damages caused by improper handling of the product.
- Reproduction of this manual in whole or in part without our prior written permission is prohibited.
- The product names mentioned in this manual may be trademarks or registered trademarks of their respective owners.

SAFETY INSTRUCTIONS

This LCD television has been designed and manufactured to meet international safety standards, but like any electrical equipment, care must be taken if you are to obtain the best results and safety is to be assured. Before using this product, please read and understand the Safety Instructions thoroughly to ensure correct usage, and follow all the instructions.

About the Symbols

Various symbols are used in this manual, the user's manual and on the product itself to ensure correct usage, to prevent danger to the user and others, and to prevent property damage. The meanings of these symbols are described below. It is important that you read these descriptions thoroughly and fully understand the contents.



WARNING

This symbol indicates information that, if ignored, could possibly result in personal injury or even death due to incorrect handling.



CAUTION

This symbol indicates information that, if ignored, could result possibly in personal injury or physical damage due to incorrect handling.

Typical Symbols



This symbol indicates an additional warning (including cautions). An illustration is provided to clarify the contents.



This symbol indicates a prohibited action. The contents will be clearly indicated in an illustration or nearby (the symbol to the left indicates that disassembly is prohibited).



This symbol indicates a compulsory action. The contents will be clearly indicated in an illustration or nearby (the symbol to the left indicates that the power plug should be disconnected from the power outlet).



WARNING

Never use the television if a problem should occur.

Abnormal operations such as smoke, strange odor, no image, no sound, excessive sound, damaged casing, elements, cables, penetration of liquids or foreign matter, etc. can cause a fire or electrical shock.

In such case, immediately turn off the power switch and then disconnect the power plug from the power outlet. After making sure that the smoke or odor has stopped, contact your dealer. Never attempt to make repairs yourself because this could be dangerous.



Disconnect the plug from the power outlet.

Do not insert liquids or foreign objects.

Penetration of liquids or foreign objects could result in fire or electrical shock. Use special caution in households where children are present. If liquids or foreign objects should enter the television, immediately turn off the power switch, disconnect the power plug from the power outlet and contact your dealer.

- Do not place the television in a bathroom.
- Do not expose the television to rain or moisture.
- Do not place flower vases, pots, cups, cosmetics, liquids such as water, etc on or around the television.
- Do not place metals, combustibles, etc on or around the television.



Never disassemble or modify the television.

The television contains high voltage components. Modification could result in fire or electrical shock.

- Never remove any fixed cover.



Do not disassemble.

Do not give the television any shock or impact.

If the television should be shocked and/or broken, it could result in an injury, and continued use could result in fire or electrical shock. If the glass panel is broken or damaged, immediately turn off the power switch, disconnect the power plug from the power outlet and contact your dealer.



Do not place the television on an unstable surface.

If the television should be dropped and/or broken, it could result in an injury, and continued use could result in fire or electrical shock.

- Do not place the television on an unstable, slant or vibrant surface such as a wobbly or inclined stand.



Do not obstruct the ventilation of the television.

If the ventilation is obstructed during the operation of the television or just after switching off the power, it could result in damage and shorten the lifespan of your television due to overheating. Make sure there is ample ventilation.

- Keep a space of 100mm (10cm) or more between the sides, rear and top of the television and other objects such as walls.
- Do not place anything around ventilation openings of the television.
- Never block ventilation openings.
- Do not put the LCD screen side up.
- Do not cover the television with a tablecloth, etc.
- Do not place the television on a carpet or bedding, or near a curtain.



Use only the correct power outlet.

Incorrect power supply could result in fire or electrical shock. Use only the correct power outlet depending on the indication on the television and the safety standard.

- The enclosed power cord must be used depending on the power outlet to be used.



SAFETY INSTRUCTIONS (continued)

WARNING

Be cautious of the power cord connection.

- Incorrect connection of the power cord could result in fire or electrical shock.
- Do not touch the power cord with a wet hand.
- Check that the connecting portion of the power cord is clean (with no dust), before using. Use a soft and dry cloth to clean the power plug.
- Insert the power plug into a power outlet firmly. Avoid using a loose, unsound outlet or contact failure.
- Do not cut off the fitted power plug, the removal of which could lead to impaired performance. If you wish to extend the lead, obtain an appropriate extension lead or consult your dealer.
- Should you require replacing the fuse in the molded plug with a new fuse, then please replace with new one of the same value, type and approval as the original. Ensure the fuse cover is returned to its original position.



Be sure to keep safety ground connection.

- Connect the ground terminal of AC inlet of this television with the ground terminal provided at the power outlet using the enclosed power cord. If the provided plug does not fit your outlet, consult an electrician for replacement of the obsolete outlet.
- The socket-outlet must be installed near the television and easily accessible.



Surely connect the ground wire.

Be careful in handling the power cord and external connection cables.

If you keep using a damaged the power cord or cables, it can cause a fire or electrical shock. Do not apply too much heat, pressure or tension to the power cord and cables. If the power cord or cables are damaged (exposed or broken core wires, etc.), contact your dealer.

- Do not place the television or heavy objects on the power cord and cables. Also, do not place a spread, cover, etc. over them because this could result in the inadvertent placing of heavy objects on the concealed power cord or cables.
- Do not pull the power cord and cables. When connecting and disconnecting the power cord or cables, do it with your hand holding the plug or connector.
- Do not place the cord near the heater.
- Do not touch the power plug just after disconnecting it from the power outlet to prevent electric shock.
- Do not touch the power plug when lightning is close to you.
- Avoid coiling the power cord and bending it sharply.
- Protect the power cord from being walked on, pinched particularly at plugs conveniences receptacles, and the point where they exit from the apparatus.
- Do not modify the power cord.



Be careful in handling the battery of the remote control.

Incorrect handling of the battery could result in fire or personal injury. The battery may explode if not handled properly.

- Keep the battery away from children and pets. If swallowed consult a physician immediately for emergency treatment.
- Do not allow the battery to be exposed to fire or water.
- Avoid fire or high-temperature environment.
- Do not hold the battery with metallic tweezers.
- Keep the battery in a dark, cool and dry place.
- Do not short circuit the battery.
- Do not recharge, disassemble or solder the battery.
- Do not physically impact the battery.
- Use only the battery specified in the manual of this television.
- Make sure the plus and minus terminals are correctly aligned when loading the battery.
- If you observe a leakage of the battery, wipe out the liquid and then replace the battery. If the liquid adheres your body or clothes, rinse well with water.
- Obey the local laws on disposing the battery.





SAFETY INSTRUCTIONS (continued)

CAUTION

Be careful in moving the television.

Neglect could result in an injury or damage.

- Do not move the television during use. Before moving, disconnect the power plug and all external connections.
- You are advised to move the television with two persons.
- Avoid any impact or shock to the television; particularly take care of glass screen.

Do not put anything on top of the television.

Placing anything on the television could result in loss of balance or falling, and cause an injury or damage. Use special caution households where children are present.

Avoid a humid or dusty place.

Placing the television in a smoke, a highly humid, dusty place, oily soot or corrosive gas could result in fire or electrical shock.

- Do not place near the kitchen, a humidifier or other place where there is oil, smoke or humidity.

Avoid a high temperature environment.

The heat could have adverse influence on the television and other parts, and could result in transformation, melting or fire.

- Do not place the television, the remote control and other parts in direct sunlight or near a hot object such as heater, etc.
- Do not put the television in a place where the temperature is widely changing.

Remove the power cord for complete separation.

- For safety purposes, disconnect the power cord if the television is not to be used for prolonged periods of time.
- Before cleaning, turn off and unplug the television. Neglect could result in fire or electrical shock.



Disconnect the plug from the power outlet.



Disconnect the plug from the power outlet.

PRECAUTIONS

Installation environment

Do not obstruct a ventilation hole.

Do not put the television on carpet or blanket, or near a curtain which has a possibility of obstructing a ventilation hole of the television.

Do not put the television in the following places.

- Hot places such as near heater, place exposed to the direct rays of the sun.
- A place where the temperature is widely changing.
- Places with soot, dust or high humidity.
- Poor air ventilation place.
- Place near fire.
- A wet place such as bathroom, or shower room.
- Place where you can trip over it.
- Always vibrating or strongly vibrating places.
- Distorted or unstable places.

How to view the television

If you use the television in too dark a room, your eyes may become tired.

Please use it in a reasonably bright room.

Avoid direct rays of the sun to the screen in order to prevent eye fatigue.

Your eyes will get fatigued after viewing the television for long period of time.

Relax your eyes by viewing away from the television from time to time.

Please watch the television in downward direction.

Avoid a image retention

- Do not display images having sharp brightness differences or high-contrast images, such as monochrome characters and graphic patterns, for long.
- Do not leave stationary images appearing for long, but try to refresh them at appropriate intervals of time.
- Turn down the contrast and brightness controls.

How to clean the LCD screen panel of the television

Before cleaning the television, turn off the television and disconnect the power plug from the power outlet.

To prevent scratching or damaging the LCD screen face, do not knock or rub the surface with sharp or hard objects.

Clean the screen with a soft cloth moistened with warm water and dry with a soft cloth. If it is not enough, then use a cloth with mild detergent. Do not use harsh or abrasive cleaners.

How to clean the cabinet of the television

Use a soft cloth to clean the cabinet and control panel of the television. When excessively soiled dilute a neutral detergent in water, wet and wring out the soft cloth and afterward wipe with a dry soft cloth.

Never use acid/alkaline detergent, alcoholic detergent, abrasive cleaner, powder soap, OA cleaner, car wax, glass cleaner, etc. especially because they would cause discoloration, scratches or cracks.



SAFETY INSTRUCTIONS (continued)

Prevention of an obstacle to Radio receivers

This television has been designed pursuant to the international EMI standards. This is to prevent a problem to Radio receivers.

- Keep the television away from Radio.
- Adjust Radio antennas in order for the television not to receive interference.
- The antenna cable of Radio should be kept away from the television.
- Use a coaxial cable for antenna.

You can check if this television influences Radio receivers by turning off all other equipment other than the television.

If you find a problem receiving Radio when using the television, check the instructions mentioned above.

Precautions for the cable connection

- Do ensure that all connections, (including the power plug, extension leads and interconnections between the pieces of equipment), are properly made and in accordance with the manufacturers instructions. Switch off and withdraw the power plug before making or changing connections.
- Confirm the connector is fixed tightly when the signal cable is connected. Also confirm the screws on the connector are tightened.
- Plug the power cord of the television into a different socket from that for other equipment, such as Radio etc.
- Use a plug with ground terminal and make sure that it connects to the ground.

Precaution during transportation

Please pay attention when you transport this television because it is heavy. Furthermore, use the original carton box and its packaging materials when the television is transported. Failure to transport the television in any carton except the original carton may result in damage to the television. Save the original carton box and all packing material.

Do not physically impact the remote control.

A physical impact could cause damage or malfunction of the remote control.

- Take care not to drop the remote control.
- Do not place heavy objects on the remote control.

Avoid strong rays.

Any strong rays (such as direct sun rays or room lighting) onto the remote control sensors could invalidate the remote control.

Avoid radio interference.

Any interfering radiation could cause distorted images or noises.

- Avoid radio generator such as a mobile telephone, transceiver, etc. around the television.

Set the sound volume at a suitable level.

It is better to keep the volume level low and close the windows at night to protect the neighborhood environment.

Precautions for the installation

- Do not use makeshift stands and NEVER fix legs with wood screws - to ensure complete safety, always fit the manufacturers approved stand or legs with the fixings provided according to the instructions.
- Use only with the cart, stand, tripod, bracket, or table specified by the dealer, or sold with the apparatus. When a cart is used, use caution when moving the cart/apparatus combination to avoid injury from tip-over.
- This product is designed to comply with the recommended safety standards for tilt and stability. Do not apply excessive pulling force to the front, or top, of the cabinet that could cause the product to overturn resulting in product damage and/or personal injury.
- Follow instructions for wall, shelf or ceiling mounting as recommended by the manufacturer.
- Only use the attachments/accessories specified by the manufacturer.
- Consult your dealer if you are in any doubt about installation, operation or safety of your equipment.

Other precautions

- Do not leave equipment switched on when it is unattended unless it is specifically stated that it is designed for unattended operation or has a stand-by mode. Switch off using the switch on the equipment and show your family how to do this. Make special arrangements for infirm or handicapped people.
- Disposal of this product may require specific instructions pertaining to your resident region.
- Never guess or take any chances with electrical equipment of any kind - it is better to be safe than sorry!



ABOUT LCD PANEL

Common phenomena of LCD Panel

The following are the common phenomena when operating LCD Panel due to its structural reason. Please note that they are not malfunctions.

•Defective Spots on Panel

The LCD panel is manufactured with high-precision technology. However, there might be some spots that are not emitted, brighter than the others, or in different colors, etc.

•Surface on Panel

The LCD panel displays images by blinking the fluorescent lamps internally. This could raise the temperature of the display surface.

In addition, do not impact strongly on the surface of the panel because LCD panel is made with fine processing glass.

•Residual image

When a still image or menu is displayed on the screen for a short time (about a minute) and then switches to another image, it may leave an "after-image" on the screen.

The residual image will disappear on its own.

•The Usage under the Low Temperature Environment

Because of the structural characteristics of the LCD panel, the response speed of the LCD panel becomes slower when the ambient temperature around the monitor becomes too low. In some cases, it may cause the residual image.

The residual image will disappear on its own as the temperature goes up and back to normal.



Location of controls

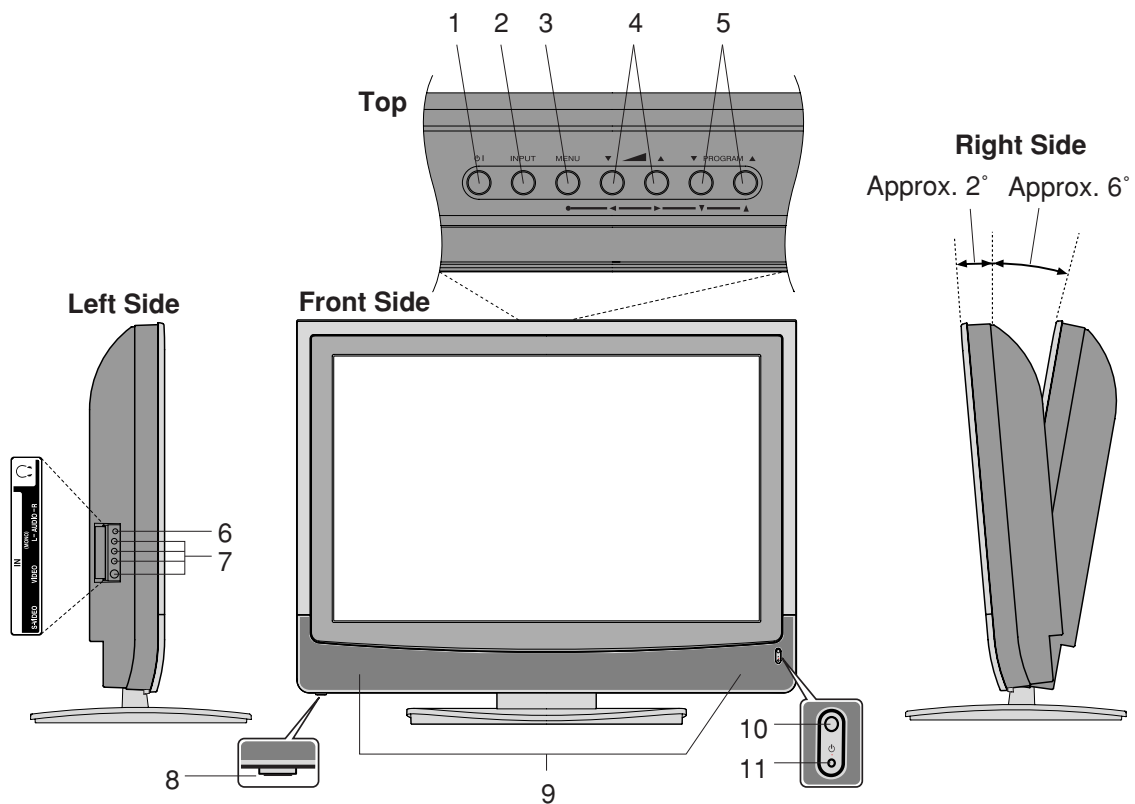

You can adjust the angle of the TV-screen for 2° forward or for 6° backward from vertical angle.

Description of Indicators and Controls

1. **⏻ | (SUB-POWER) button:** To turn the unit standby mode on and off.
2. **INPUT-button:** Select input mode for TV/AV/COMPONENT/HDMI/PC.
3. **MENU-button:** To display the menu-screen.
4. **VOLUME ▲/▼ buttons :** To adjust the volume. In Menu : Setting.
5. **PROGRAM ▲/▼ buttons:** Press ▲ to change to a higher numbered channel set into memory. Press ▼ to change to a lower numbered channel set into memory. In Menu : Setting. In Standby : Turning on the unit.
6. **HEADPHONES jack:** Plug headphones with a mini plug (3.5 mm) into this jack.
7. **AV3-Input:** Input for analogue A/V-Signal (Composite). If your equipment has an S-video connector, use an S-video cable instead of a standard yellow video cable (You still must connect the standard red and white audio cables for full system connection, but do not connect a standard yellow video cable at the same time or the picture performance will be unacceptable.)
8. **Main Power Switch:** To turn the unit on or off completely.
9. **Loudspeakers**
10. **Remote sensor**
11. **STANDBY/ON mode indicator:** It lights up in red at STANDBY, and in green at POWER ON.



Remote Control

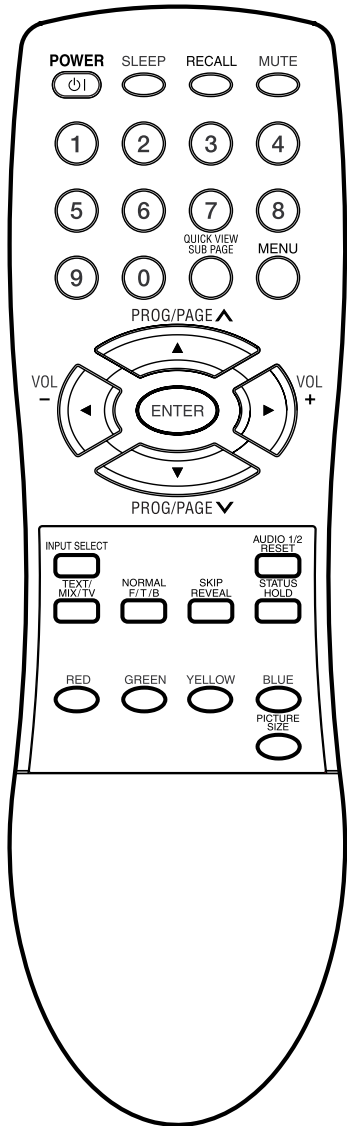

	Function	Page
	Turn the unit on or off	18
	Sleep-Timer	23
	Display program position number	23
	Turn the sound on/off	23
	Select channel Select Teletext page	20 23 37 39
	Switches between the present channel and the last selected channel Sub Page selection	23 38
	Call Menu	
	Select TV-channel or Teletext page step by step In Menu: Setting In Standby: Turning on the unit	23 37 39 18
	Volume In Menu: Setting	23
	Memorize	
	Select input source	18
	Two Channel-Sound AUDIO 1/2 selector Teletext page 100	26 38
	Teletext ON/ Mix/ OFF	37
	Reset Sound/Picture Teletext enlargement	27 29 35 38
	Program position-skipping Answer a Quiz	39 38
	Teletext-Timer display Hold the text page	23 38
	Fastext/TOPtext buttons	37
	Select picture format	31



ENGLISH

Remote Control

Install the batteries

Use batteries type UM-4 (AAA-Size). Do not use the storage batteries. The remote control does not work properly with weak voltage from the storage batteries. Replace the exhausted batteries with new batteries. Never charge batteries. Batteries may explode by the charge.

Note:

An exhausted empty batteries may leak, namely corrosive electrolyte will leak out. The remote control may damage by it. Therefore remove the exhausted batteries early.

1 Open the battery compartment.

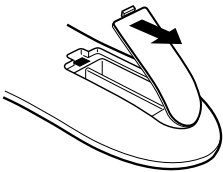

2 Install the batteries as shown below.

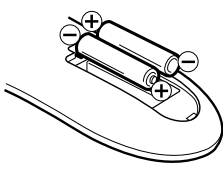

3 Close the battery compartment.

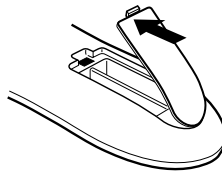

Distance of Remote Control Operation

Point the remote control directly at the remote sensor.

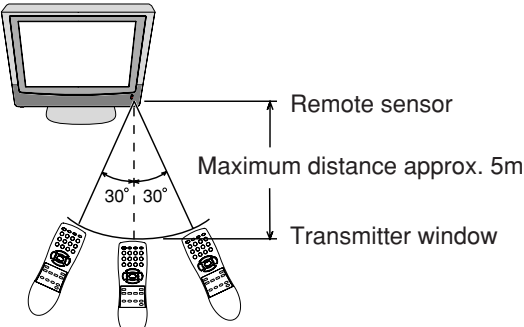

The remote control handset will not work properly in the following cases:

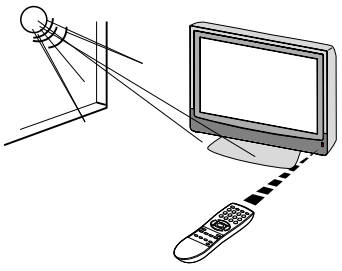

If bright sunlight directly beams onto the unit front.

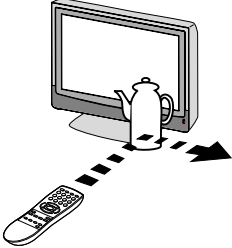

If an obstacle is placed between the unit and the handset.

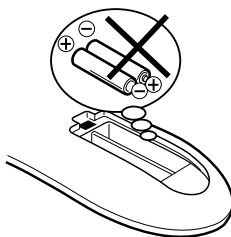

If the batteries have not been installed according to their polarities.

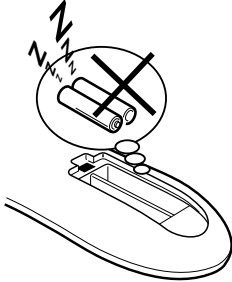

If the batteries are weak.

Antenna connection

Note: Before you connect something:

- To avoid every possible damage, turn off the TV-unit with Main Power Switch and then pull the power plug out.
- Arrange the desired connection.
- When the connection made up firmly and correctly, connect the unit to AC100-240V, 50/60Hz and turn the unit on.
- For safety, install an external aerial conforming to AS1417.1 (applicable for Australia only).

Connect the antenna as shown below. Connect the unit with an outdoor antenna (A) or a cable-net (B). In case of reception disturbance, consult with a specialist of antenna.

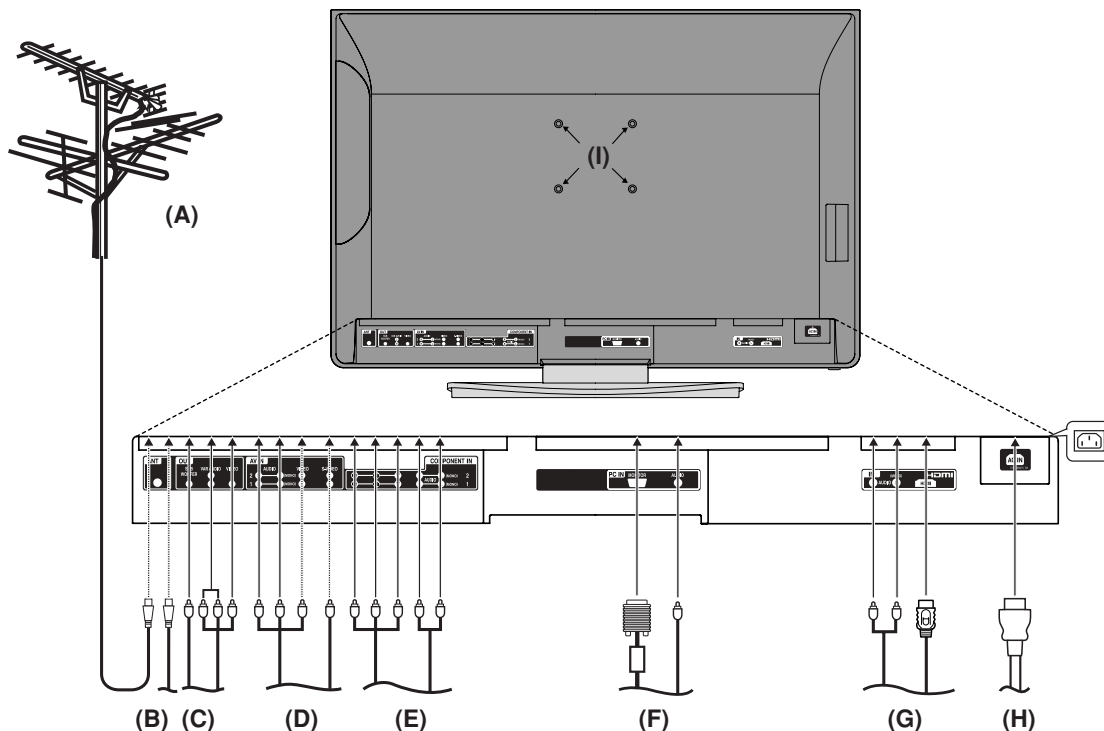

- (A) **Outdoor antenna:** If the outdoor antenna already exists, you can also connect to it for analog TV-program.
- (B) **Antenna connection:** The built-in Hyperband CATV tuner can receive all analog cable television programs.
- (C) **Audio/Video/Subwoofer output:** To connect with an audio amplifier and external speakers or Subwoofer, and adjust the audio level using the TV's remote control.
To control the audio, turn off the TV's built-in speakers [28](#).
Signal from Video output jack are composite video signals.
- (D) **AV1/AV2 input:** To the connection of audio and composite video/S-video cables.
- (E) **COMPONENT-1/2 input:** To the connection of audio and component cables.
- (F) **PC Monitor input (PC):** [16](#) [35](#).
- (G) **HDMI input:** [16](#) [36](#).
- (H) **Power supply:** Connect the supplied power cable. Connect to AC100-240V, 50/60Hz.
Never repair a damaged AC power cord with isolation-tape. Have a specialist exchange with a new AC power cord. Do not let your pet loose near the cable. To bite isolation is danger of life. Above all, a rat, a parakeet, a hamster, a rabbit and other toothed animals can bite the cable.
- (I) **Bracket holes:** Fix a wall mounting bracket (not supplied) here.

Connections to other equipment

The exact arrangement you use to interconnect various video and audio components to the LCD television is dependent on the model and features of each component. Check the Owner's Manual provided with each component for the location of video and audio inputs and outputs.

The connection diagrams below are offered as suggestions. You may need to modify them to accommodate your particular assortment of components. The diagrams are intended to show component video and audio interconnections only.

Note: Select an appropriate external input mode  18.

To connect the LCD television to a VCR

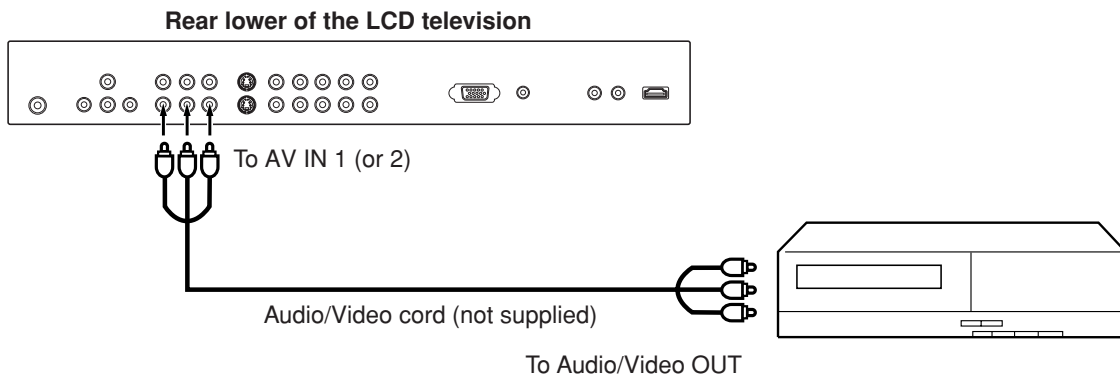

To connect the LCD television to a VCR with an S-Video cord

If you connect a VCR with a S-VIDEO cord to the S-VIDEO IN jack on the rear of the LCD television, you must also connect the audio cords to the AUDIO IN jacks on the rear of the LCD television. The S-VIDEO cord only carries the video signal. The audio signal is separate.

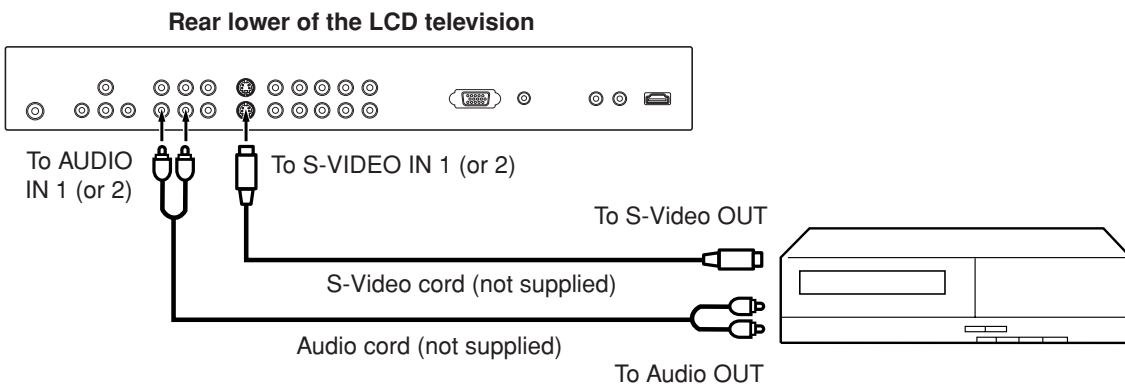

NOTE:

When the S-video cord and the video cord are connected to each jack at the same time, the S-video cord takes precedence over the video cord.



Connections to other equipment

To connect the LCD television to a DVD player/Satellite receiver

If your DVD player or Satellite receiver has a S-Video out jack, connect cords as shown.

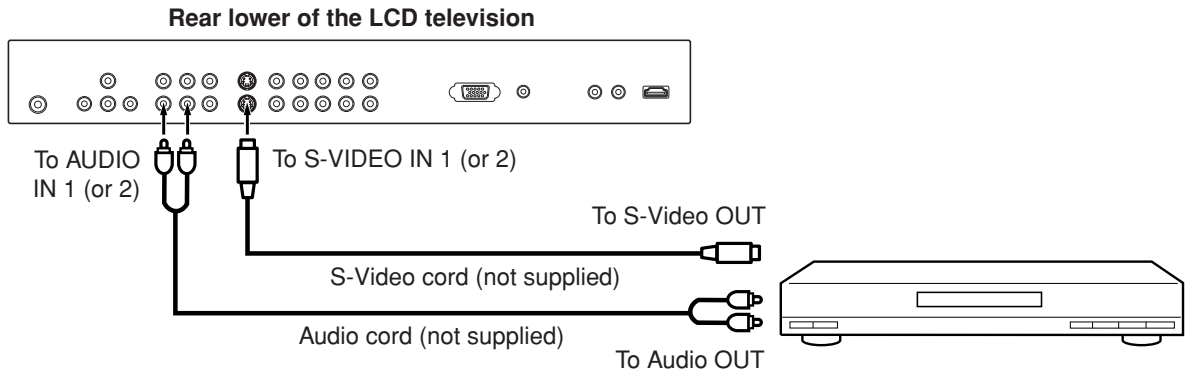

To connect the LCD television to a DVD player with component video

If your DVD player has component video out jacks, connect your LCD television to a DVD player using a component video cord. It can greatly enhance picture quality and performance.

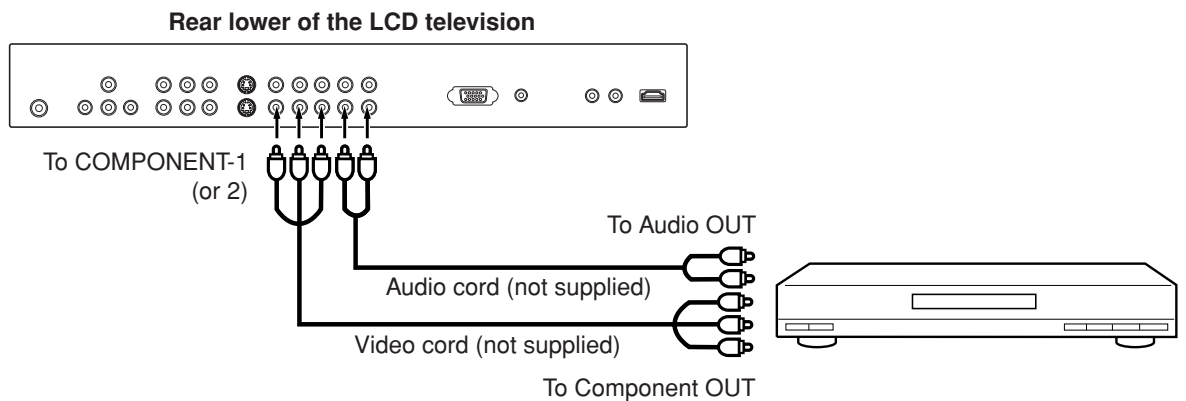

NOTE:

Component Video input of this unit are for use of device which output interlaced signals (PAL: 576i/1080i or NTSC: 480i/1080i) and progressive signals (PAL: 576p/720p or NTSC: 480p/720p).

Connections to other equipment

To connect the LCD television to a DTV receiver/set-top box

If you connect a DTV receiver/set-top box, connect your LCD television to a DTV receiver/set-top box using a component video cord.

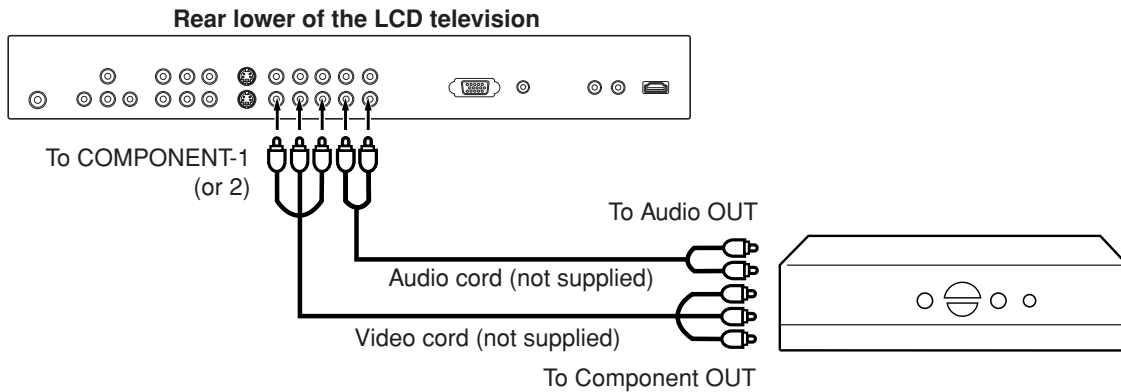

Connecting an audio system or Subwoofer

This connection allows you to use an audio amplifier and external speakers or Subwoofer, and adjust the audio level using the LCD television's remote control.

To control the audio, turn off the LCD television's built-in speakers (see "Turning off the built-in speakers" on [28](#)).

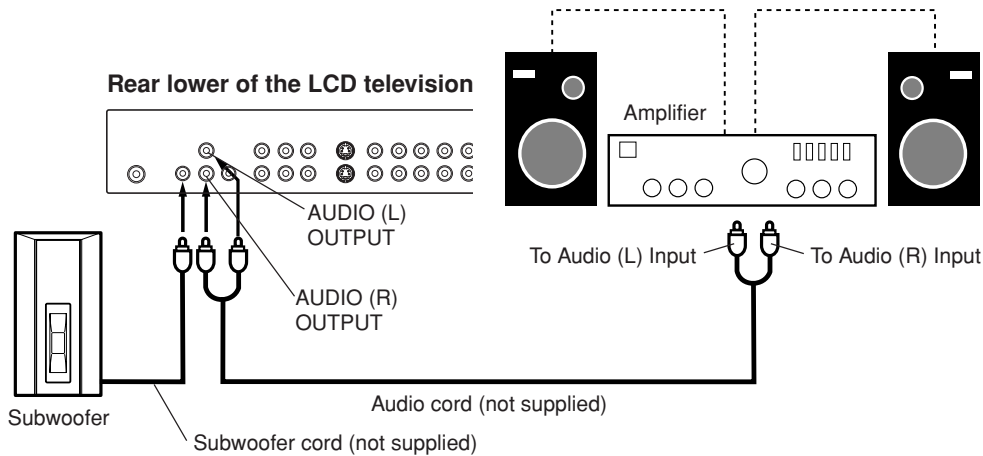

Note:

To hear sound when using an external audio amplifier or Subwoofer, the volume of both the LCD television and the amplifier/Subwoofer must be set above 0 (zero). For example, if the volume of the LCD television is set to 0, you will not be able to hear any sound, even if the volume of the amplifier/Subwoofer is at its highest level.



Connections to other equipment

To connect the LCD television to a HDMI or a DVI device

The HDMI input receives digital audio and uncompressed video from a HDMI device or uncompressed digital video from a DVI device.

When you connect to a DVI device with a HDMI-to-DVI adapter cable, it transfers only the video signal. Separate analog audio cords are required.

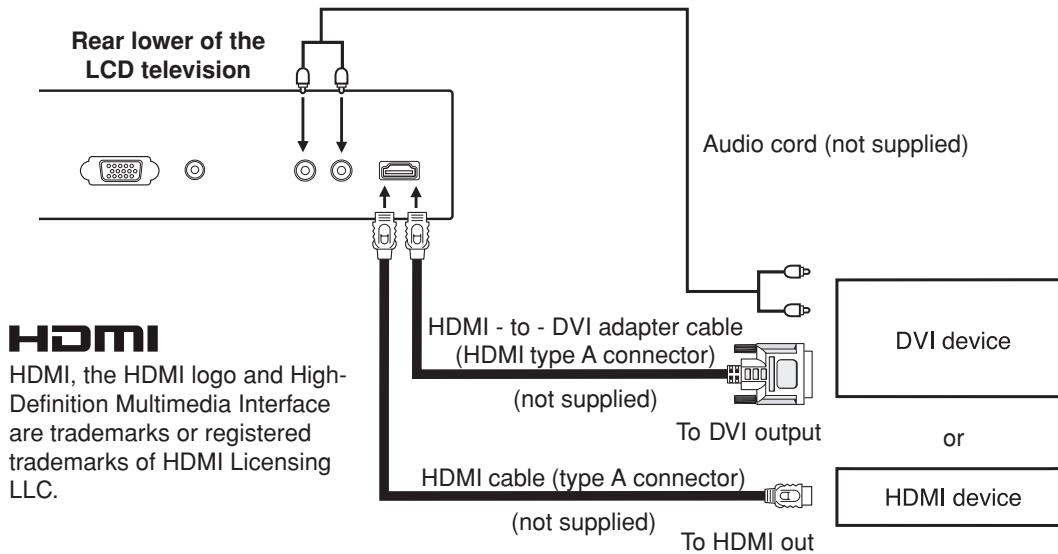

NOTE:

You must choose an appropriate setting for each connection [36](#).

To connect the LCD television to a PC (Personal Computer)

Before you connect this LCD television to your PC, change the adjustment of your PC's Resolution and Refresh rate (60 Hz).

Connect one end of a (male to male) VGA cable to the video card of the computer and the other end to the VGA connector PC MONITOR on the back of the LCD television. Attach the connectors firmly with the screws on the plug. In case of a Multimedia computer, connect the audio cable to the audio output of your Multimedia computer and to the AUDIO connector of the PC AUDIO IN jack of the LCD television. Switch on the computer. The LCD television can operate as the computer monitor.

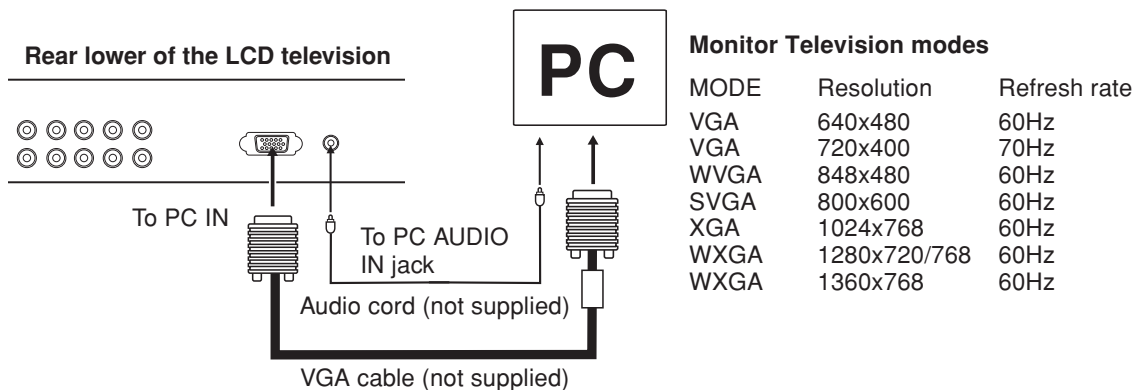

Note:

If there is no video signal from the computer when the unit is in PC mode, "NO SYNC. SIGNAL" will appear on the TV-screen for approx. 10 seconds.



Connections to other equipment

To connect the LCD television to a camcorder

To playback from a camcorder, connect the camcorder to the LCD television as shown.

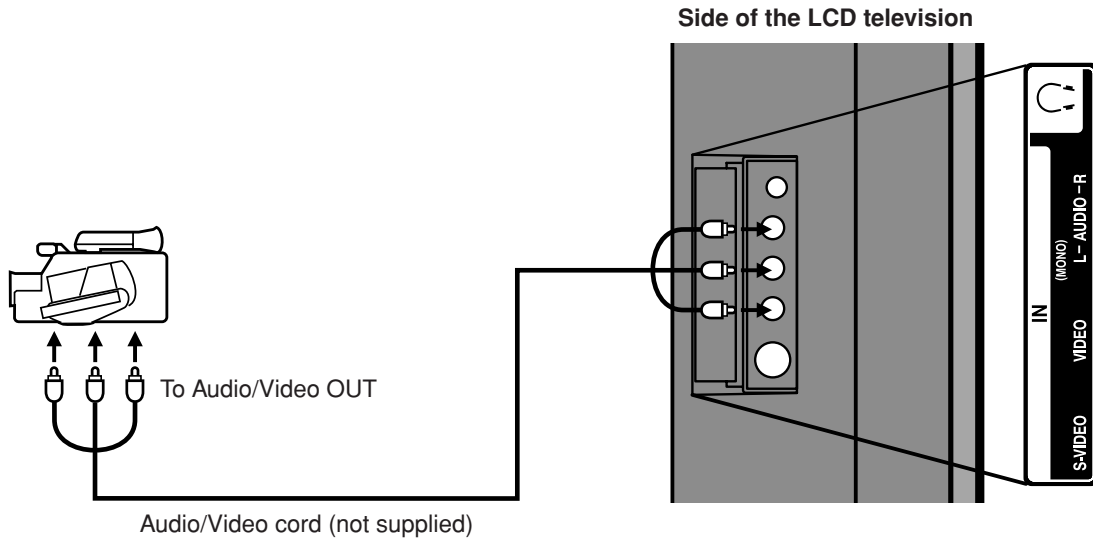

To connect the LCD television to a Game

The LCD television can also be used as a television device for many video games. However, due to the wide variety of signals generated by these devices and subsequent hook-up variations required, they have not all been included in the suggested connection diagrams. You'll need to consult each component's Owner's Manual for additional information.

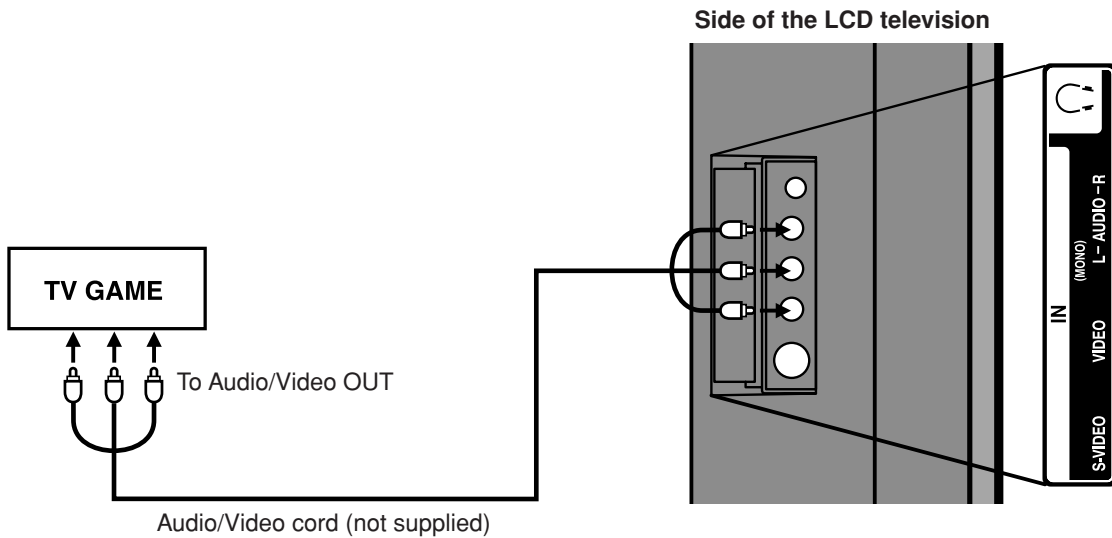

Quick guide for MENU-operation/Selecting the video input source

Make sure the antenna connection and power supply as the description on .

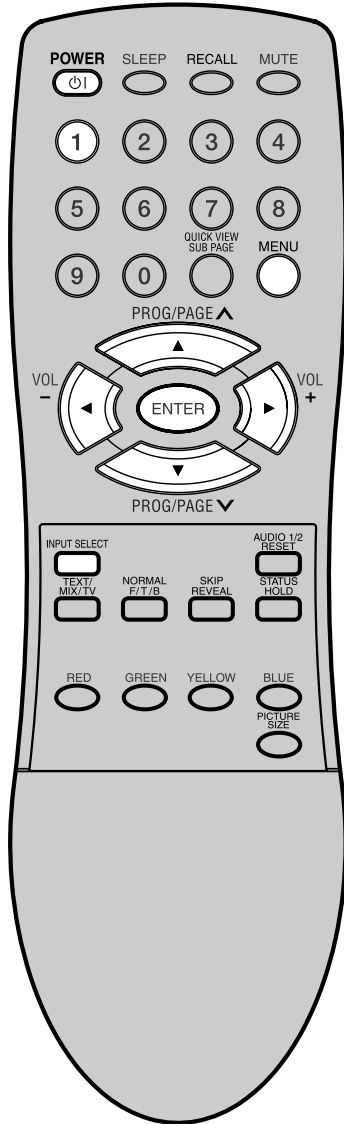



Note:

If no buttons are pressed for more than approx. 60 seconds, the MENU disappears automatically.



Quick guide for MENU-operation

Preparation:

- Turn on the unit with Main Power Switch on the bottom left of screen. Standby indicator will light up in red. Then press  (**SUB-POWER**) on the unit or remote control. Standby indicator will change to green. You can also turn on the unit with PROGRAM / on the remote control.
- Press 1. CH1 will appear.

Call MENU and for example: Select AUTO TUNING.

- 1 Press **MENU**.
If you press **MENU** for the first time after the purchase, the Language-selection screen (step 1 on next page) will appear.

- 2 Press  or  to select .

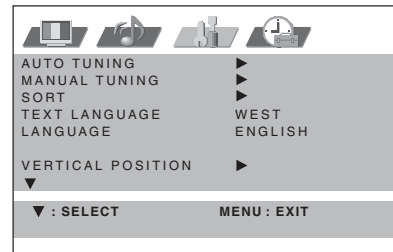

- 3 Press  or  to select **AUTO TUNING**.

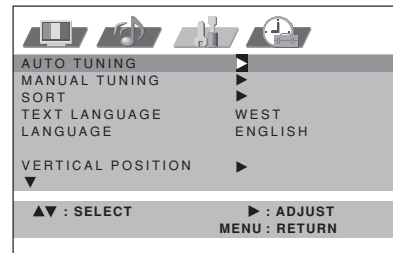

... on the following pages the MENU can be called in the same way as here.



- 4 Press **MENU** repeatedly until the MENU disappears.

Selecting the video input source

Press **INPUT SELECT** to view a signal from another device connected to your TV, such as a VCR or DVD player. You can select each input source depending on which input jacks you used to connect your devices.

To select the video input source, press / or the corresponding number button. Then press **ENTER** within 6 seconds.

```
0 . TV
1 . AV 1
2 . AV 2
3 . AV 3
4 . COMPONENT 1
5 . COMPONENT 2
6 . HDM I
7 . PC
```

```
[ 0 - 7 ] : SELECT
ENTER : SET
```

On-screen Language Selection/Teletext Language Selection

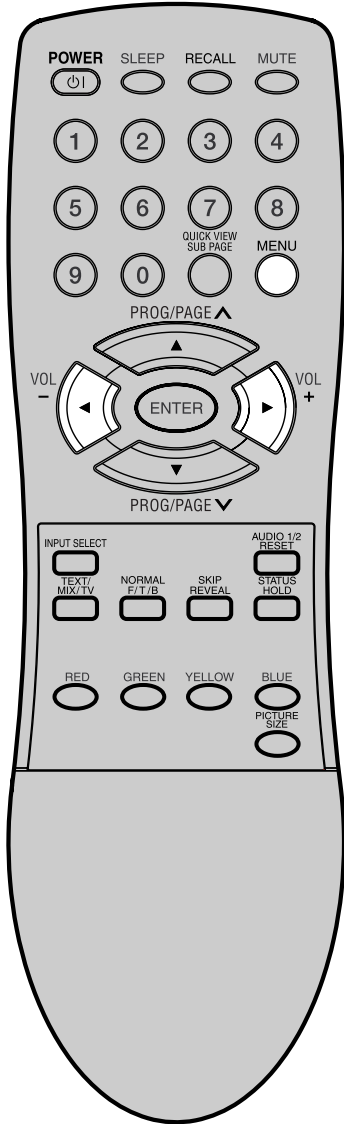

On-screen Language Selection

- 1 Select LANGUAGE.
Then press (◀) or (▶) to select the desired language.

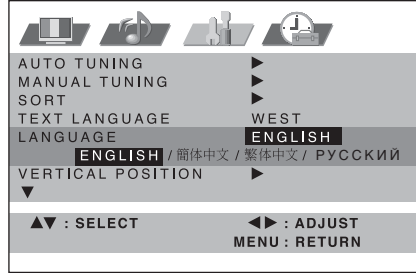

- 2 Press **MENU** repeatedly until the MENU disappears.

Teletext Language Selection

- 1 Select TEXT LANGUAGE.
Then press (◀) or (▶) to select WEST or EAST.

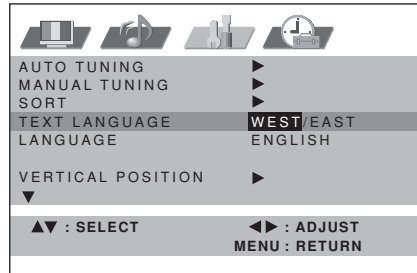

- 2 Press **MENU** repeatedly until the MENU disappears.

ENGLISH

Automatic station presetting with the built-in Tuner

Your television has an Automatic Tuning System which makes tuning in your television easy. This Automatic Tuning System scans the entire reception range in your area and automatically stores all available channels of suitable signal strength in the correct order. Please note that the Auto tuning facility can only search for analogue signals - if you have any digital decoders connected, please refer to their instructions for details of how to set them up.

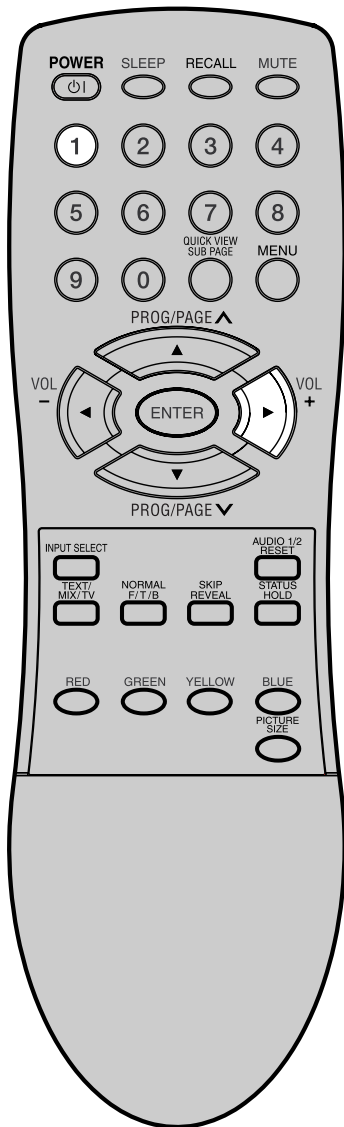

Preparation:

Connect a antenna or a cable-net.

Do not connect any other unit or cable.

To avoid every reception disturbance, all connected unit must be turned off and power supply is disconnected.

Press 1-button. CH1 will appear.

1 Select AUTO TUNING.

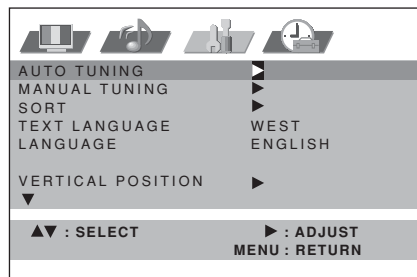

2 Then press .

The broadcast-searcher searches the broadcasts and stores them in order. During the search the sound is muted.

When all programs have been stored, the AUTO TUNING menu will appear automatically.

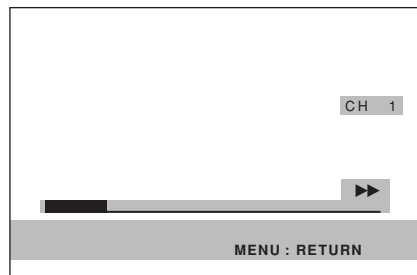

Note:

If you receive a signal of NTSC4.43 from ANT IN (e.g. connect with your VCR) and then tuning with AUTO TUNING, its color and sound may not come out. But it is not a failure.

In case you tune to the NTSC4.43-signal, perform MANUAL TUNING on  22 setting color system on step 2 as "NTSC4.43".

Change the order of stored channel

The Automatic station presetting stores the found station in a specific order. This order can be changed.

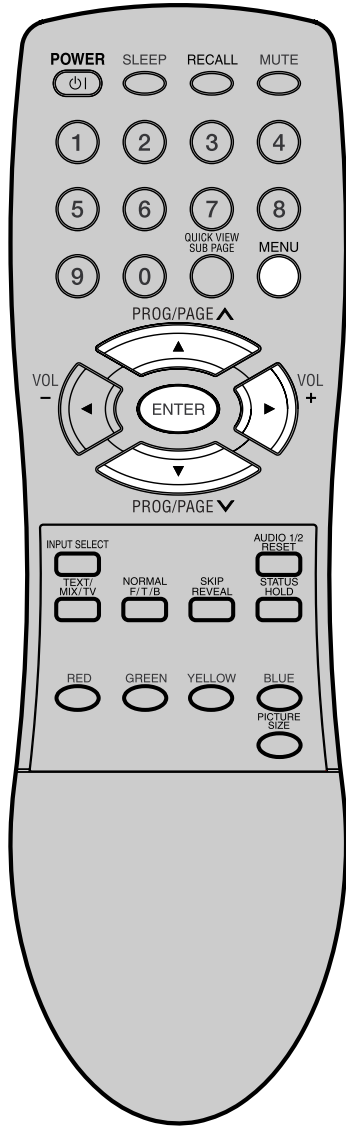

Note:

To arrange all channels, begin with program 1. Furthermore, continue this procedure to select the broadcast that should be seen on program-position 2, 3, 4 and so on.

- 1 Select SORT.
Then press

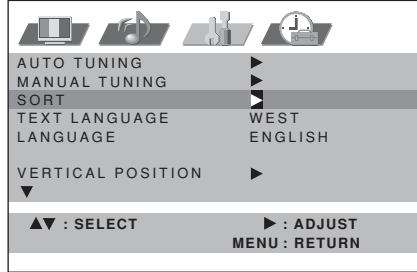

- 2 Press or until the position number that you want to move appears (e.g. CH 40), then press **ENTER**.

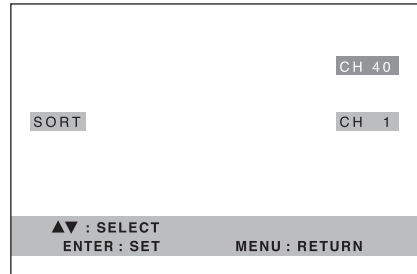

- 3 Press or until the program-position on which you want to put the moving program appears (e.g. CH 5), then press **ENTER**.

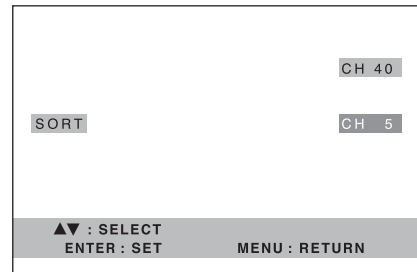

- 4 The original program 40 is now stored in memory position 5. To arrange the other channels, repeat this procedure.

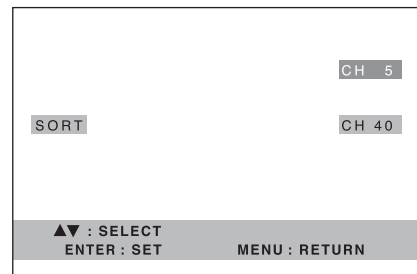

- 5 Press **MENU** repeatedly until the MENU disappears.

ENGLISH

Manual TV station presetting

Usually Automatic station presetting stores all stations of each reception-area. In case of bad receiving condition, some broadcasts may not be stored. These stations can also be stored manually.

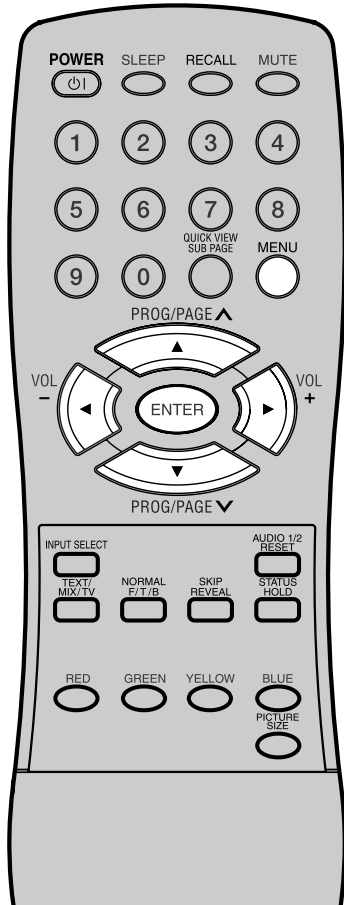

Notes:

- The auto search stops at the best receiving position automatically. A manual fine tuning is normally not necessary. If want, you can do the manual fine tuning additionally. In step 3, when the auto search stopped at each station, press or until the desired fine tuning achieved. Then press **ENTER**.
- The search moves up to the next station position automatically. If want, you can also hold the search manually. Press or at the desired position. The search keeps hold. If want, do the fine tuning as the description above.

Example: Preset the BBC on program position 2.

- 1 Select **MANUAL TUNING**. Then press .

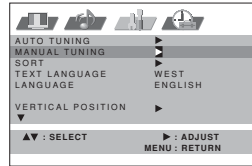

- 2 Press or to select color system (e.g. PAL). Then press **ENTER**.

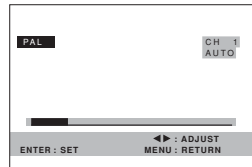

- 3 Press . The auto search starts forward. It will stop at each station with good reception. Press again until you receive the BBC. Then press **ENTER**.

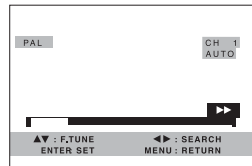

- 4 Press or to select sound system (e.g. AUTO). Then press **ENTER**.

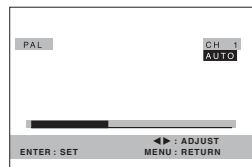

- 5 The channel position number will be highlighted. Press or repeatedly until the number next to CH change to 2. Then press **ENTER**. The BBC was now stored in the channel position **CH 2**.

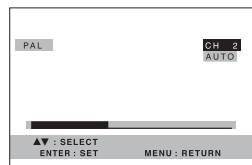

- 6 Repeat the steps 2 - 5 to preset other TV stations.
7 Press **MENU** repeatedly until the MENU disappears.



Basic Operation

Channel selection

With the **10 number buttons**.

Example:

- CH 2: Press **0, 0, 2** continuously. The station stored in the position 2 will appear.
- CH 29: Press **0, 2, 9** continuously. The station stored in the position 29 will appear.
- CH 107: Press **1, 0, 7** continuously. The station stored in the position 107 will appear.

Press or to change to the program forward or backward. The changing takes approx. 2 seconds. If the auto search stored only 5 stations, these only 5 also will appear. Still uncovered or hidden store position will not appear .

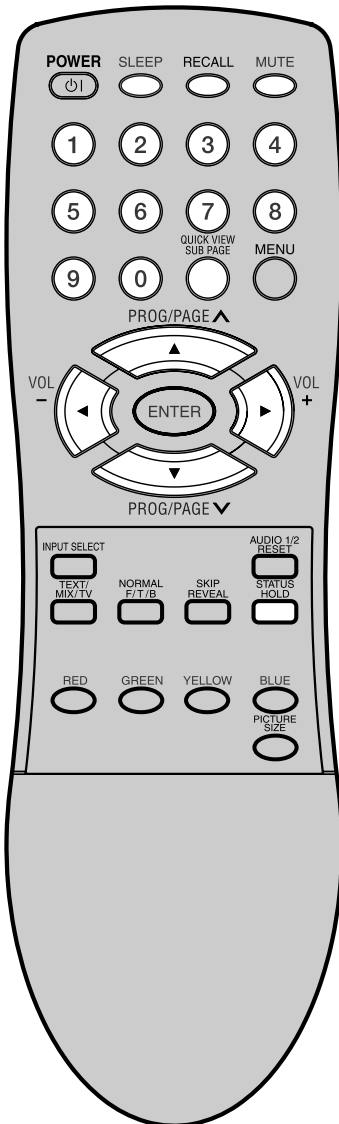

QuickView

QUICK VIEW button allows you to go back to the last selected channel.

Volume adjusting

Press or to adjust the volume. The volume level disappears after 4 seconds.

MUTE

Press **MUTE**. The sound will be cut off. MUTE will appear for approx. 4 seconds. The muting can be released by pressing **MUTE** again or or .

RECALL

Press **RECALL**. Channel number and wide screen type will appear. The display will disappear after 4 seconds.

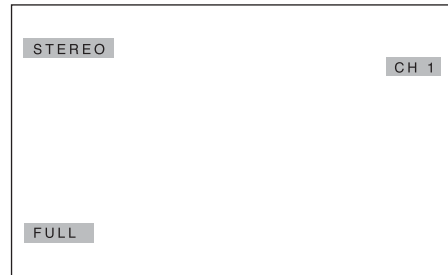

STATUS

Press **STATUS**. The clock and a program information will appear approx. 2 seconds later, if the station supported.

SLEEP TIMER

Press **SLEEP**. SLEEP and the minutes until the shut-off will appear. Each time you press **SLEEP** the number near SLEEP will change.



When the displayed time runs out, the unit will switch to standby. The display will disappear after approx. 4 seconds.

To cancel the sleep timer:

Press **SLEEP** repeatedly until "0" appears.

Note:

If the built-in tuner does not receive anything (e.g. if no antenna is connected) during TV-operation, then the TV-unit will change to standby after approx. 15 minutes.

Timer functions

The on timer feature allows you to automatically turn on your TV after a preset amount of time (up to 12 hours and 59 minutes) at the selected channel.

The off timer also allows you to turn off your TV after a preset amount of time. You can set the off timer in conjunction with the on timer.

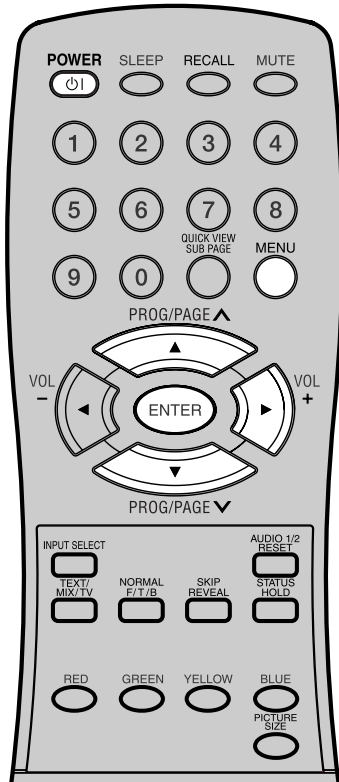

Notes:

- The button allows you to set the time in step 2 backward.
- When a timer-event is executed, the timer will return to 00:00.
- If the OFF TIMER and SLEEP-timer overlapped, the TV will shut off with the earlier reached timer.
- The TV will automatically turn off approximately 1 hour later after the ON TIMER turns on the TV. If you wish to continue watching the TV, press any button to cancel the one hour automatic shut off. This shut off feature prevents the TV from playing continuously if no OFF TIMER is set. If OFF TIMER is set, the shut off feature does not work.

Example: Turning on the TV to channel 3 at 10:30.

- 1 Select ON TIMER.
Then press **ENTER**.

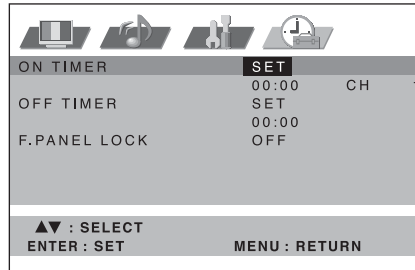

- 2 Press or to enter the hours and minutes at which you want your TV to automatically switch on.

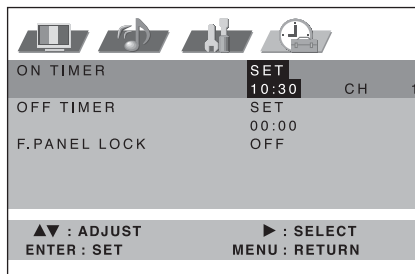

- For rapid time change in ten minute intervals, press and hold the or button.

Press .

- 3 Press or to select the channel you wish to display when you TV switches on.
Press **ENTER**.

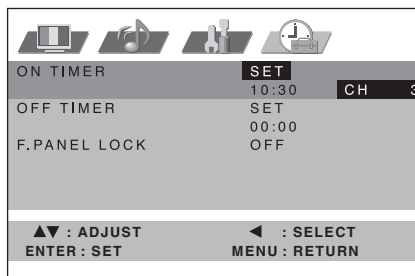

If you wish to set the OFF TIMER, press or to select OFF TIMER at step 1.

- 4 Press **MENU** repeatedly until the MENU disappears.
Put your TV into standby mode by pressing (**SUB-POWER**) button.

Stereo reception with the built-in tuner

This built-in Tuner can receive Stereo-/2 channel-program. In case the Stereo broadcast was send out with NICAM, this unit can distinguish these NICAM Stereo broadcasts automatically.

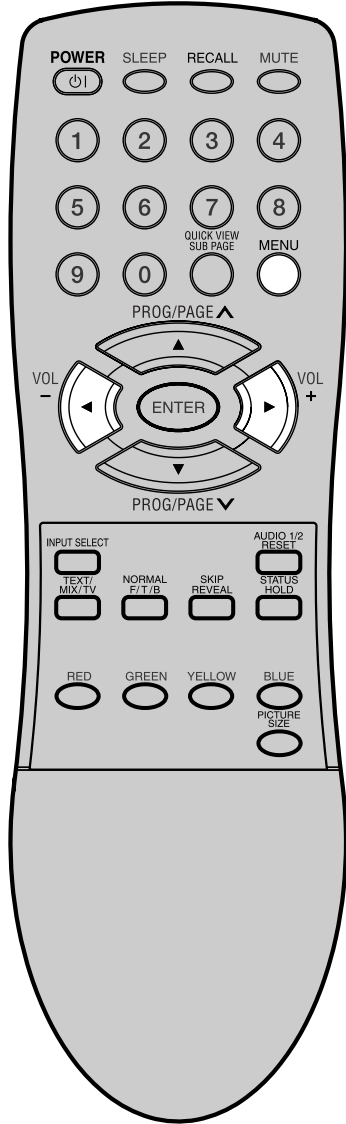

NICAM stereo sound reception:

- 1 Select NICAM.
Press or to select AUTO or OFF.
Select OFF if you want no NICAM-reception.

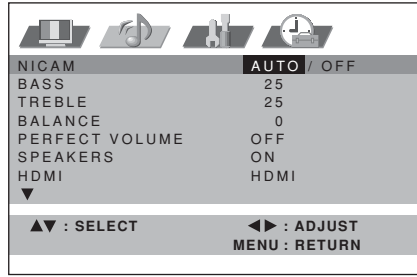

- 2 Press **MENU** repeatedly until the MENU disappears.

Followings can be displayed by NICAM-reception.

"NICAM ST" illuminates for approx. 4 seconds when a NICAM STEREO broadcast signal is received.



"NICAM M1" illuminates for approx. 4 seconds when a NICAM MONO A broadcast signal is received.



"NICAM M1/M2" illuminates for approx. 4 seconds when a NICAM MONO A and MONO B broadcast signal is received.

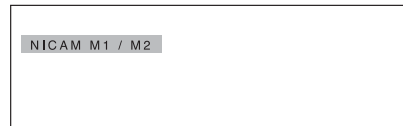

It will be displayed for the NICAM signal for approx. 4 seconds when the "NICAM OFF" is selected in menu screen.



Notes:

- In case of bad reception, the stereo sound also can be disturbed.
- A stereo is not available in the broadcast area of only NTSC.

A2 Stereo reception

"STEREO" illuminates for approx. 4 seconds when a A2 STEREO broadcast signal is received.





Stereo reception with the built-in tuner

In case of 2 channel-sound reception, you can select the desired sound with AUDIO 1/2.

Each time you press the **AUDIO 1/2**, the both sound channels alternate with each other.

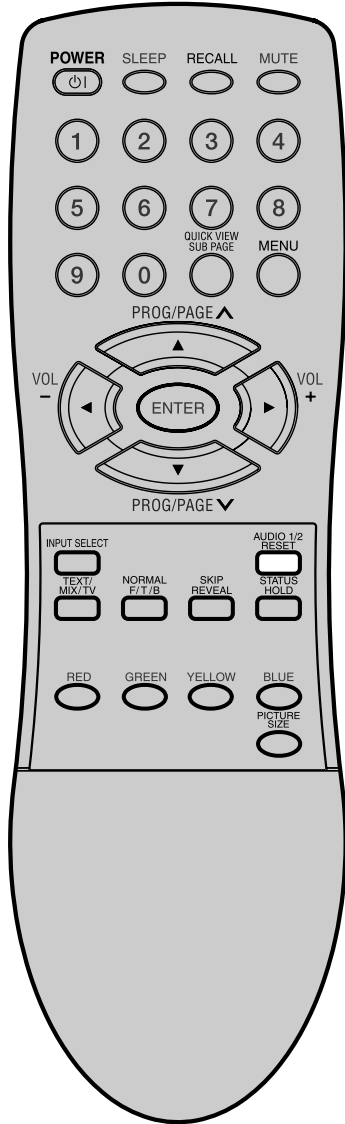

NICAM-2 channel-Sound reception

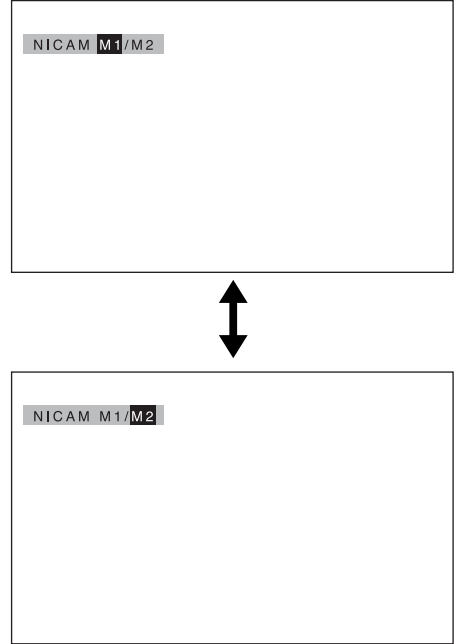

A2 STEREO-2 channel-Sound reception

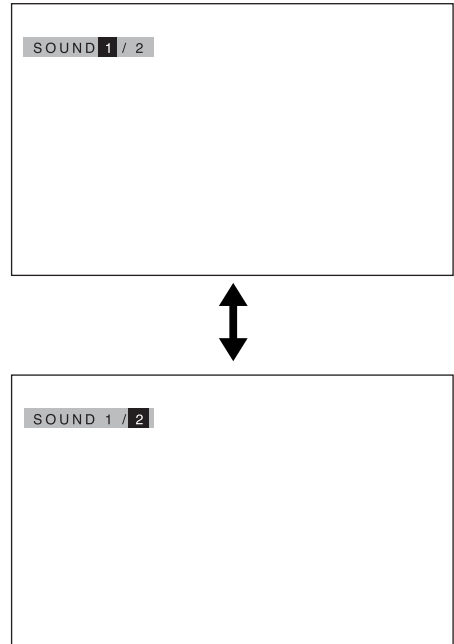



ENGLISH

Bass, Treble and Balance/Perfect Volume

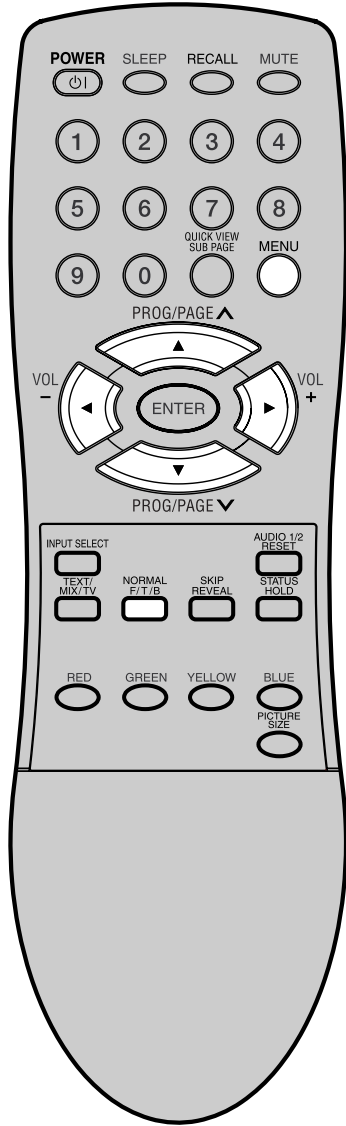

Bass, Treble, and Balance

1 Select BASS. Then press (◀) or (▶) to adjust the bass.

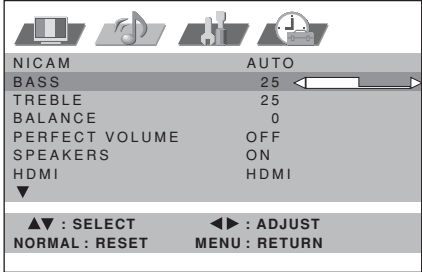

If you wish to set the treble or balance, press (▲) or (▼) to select TREBLE or BALANCE.

2 Press **MENU** repeatedly until the MENU disappears.

Perfect volume

This will automatically adjust volume so each channel and input has the same average volume level.

1 Select PERFECT VOLUME. Then press (◀) or (▶) to select ON or OFF.

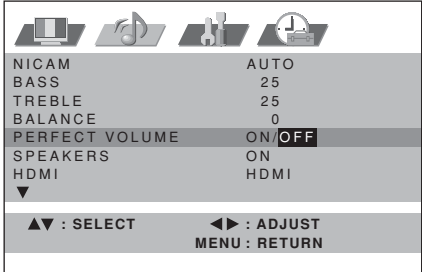

2 Press **MENU** repeatedly until the MENU disappears.

Note:

To centralize BASS, TREBLE and BALANCE, press **MENU** and select each setting option (e.g. BASS). Then press **NORMAL**. The selected option return to center level.



Turning off the built-in speakers/Using the wow™ surround sound feature

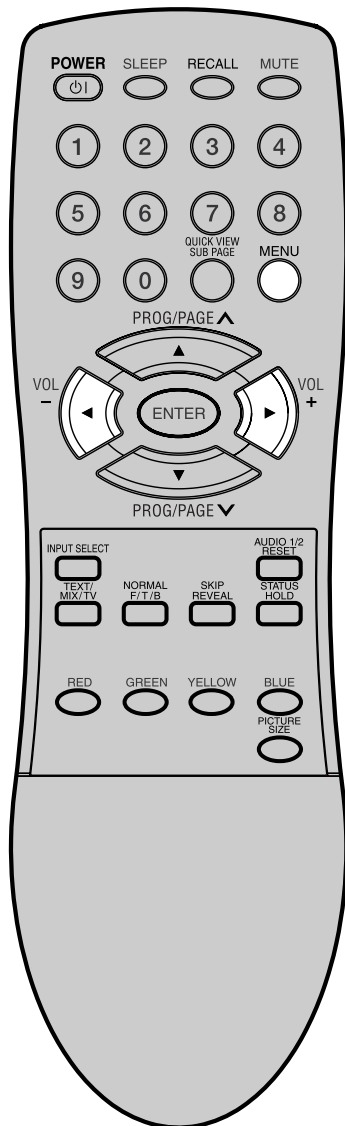

Turning off the built-in speakers

Use this feature to turn the TV speakers off when you connect an audio system 15.

- 1 Select **SPEAKERS**.
Then press or to select ON or OFF.

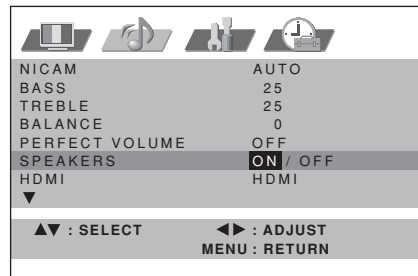

- 2 Press **MENU** repeatedly until the MENU disappears.

Using the WOW™ surround sound feature

WOW is a special combination of SRS Labs audio technologies that creates a thrilling surround sound experience with deep, rich bass from stereo sound sources. Your TV's audio will sound fuller, richer, and wider. WOW consists of three features; SRS 3D, FOCUS, and TruBass.

- 1 Select desired WOW feature you want to adjust.
Then press or to select the desired mode.

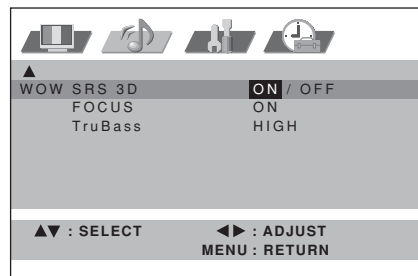

Notes:

- Make sure the volume control of your audio amplifier is set to a moderate listening level.
- If the broadcast is monaural, the SRS 3D effect will not work.
- The headphone jack, variable audio OUT jacks and Subwoofer OUT jack do not output any of the WOW audio features.

- SRS 3D — To turn on or off the surround sound effect.
- FOCUS — To turn on or off the vocal emphasis effect.
- TruBass — To select your desired bass expansion level (HIGH, LOW or OFF).

- 2 Press **MENU** repeatedly until the MENU disappears.



WOW, SRS and ® symbol are trademarks of SRS Labs, Inc. WOW technology is incorporated under license from SRS Labs, Inc.



Brightness, Contrast, Color and Sharpness/DNR

ENGLISH

Brightness, Contrast, Colour and Sharpness

- 1 Select BRIGHTNESS. Then press or to adjust the brightness.

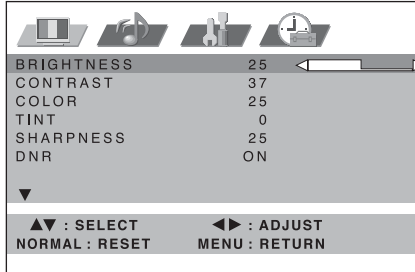

If you wish to set the contrast, color, tint, or sharpness, press or to select CONTRAST, COLOR, TINT, or SHARPNESS.

The menu "TINT" can be selected at AV-Playback, if a NTSC 3.58MHz signal comes in through a AV socket and NTSC or AUTO was selected at COLOR SYSTEM 40.

- 2 Press **MENU** repeatedly until the MENU disappears.

DNR

DNR (Digital Noise Reduction) can reduce the roughness of the picture.

- 1 Select DNR. Then press or to select ON or OFF.

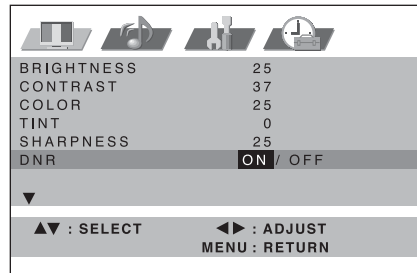

- 2 Press **MENU** repeatedly until the MENU disappears.

Notes:

- To centralize these picture adjustments, press **NORMAL** in step 1.
- In HDMI or COMPONENT mode, the "DNR"-option can not be selected.

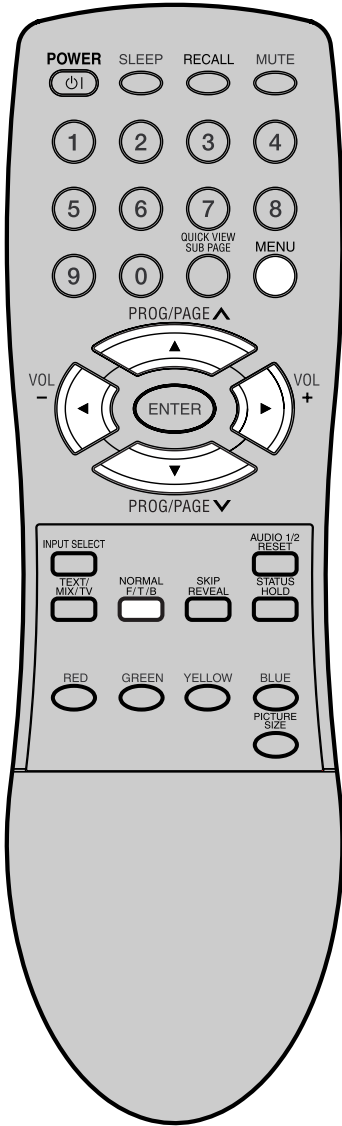



Selecting the color temperature/Film mode

Selecting the color temperature

Change the picture quality by selecting from three preset color temperatures –cool, normal and warm– as described in the following table;

- 1 Select COLOR TEMPERATURE.

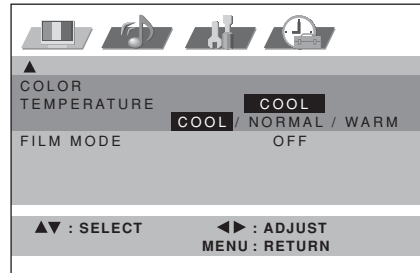

- 2 Press (Left Arrow) or (Right Arrow) to select the desired setting.

Mode	Picture Quality
COOL	Bluish
NORMAL	Neutral
WARM	Reddish

- 3 Press **MENU** repeatedly until the MENU disappears.

Film mode

You can set the TV to automatically detects the movie film material and faithfully reproduces the original film image.

- 1 Select FILM MODE. Then press (Left Arrow) or (Right Arrow) to select ON or OFF.

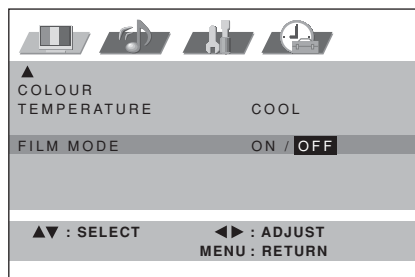

- 2 Press **MENU** repeatedly until the MENU disappears.

Note:

FILM MODE is not available in PAL or SECAM-signal mode.

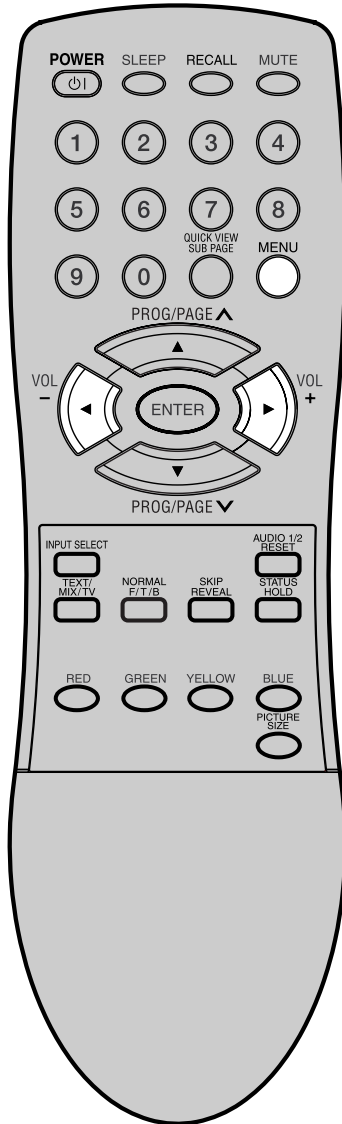

Picture format

Each time the PICTURE SIZE button is pressed, the screen display size will change in sequence.

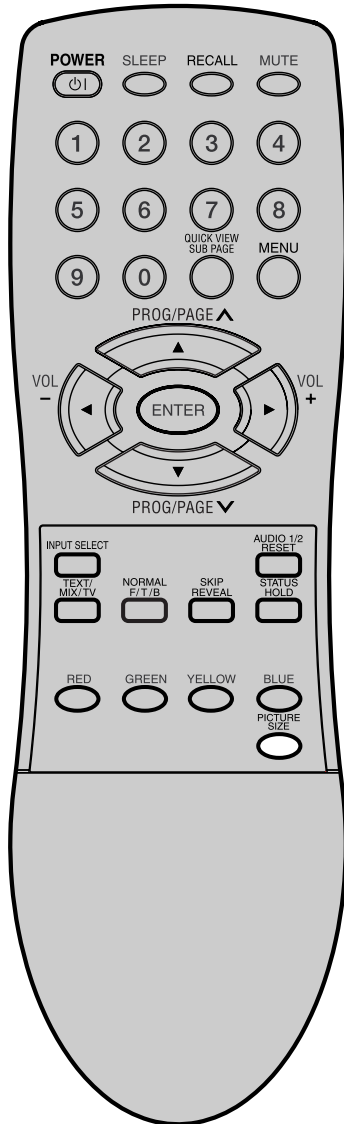

4:3

It shows a 4:3-picture in original size with black bands on left and right side.

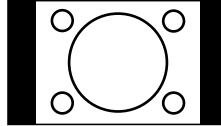

PANORAMIC:

Stretches the left and right hand sides of a 4:3 picture horizontally to fill the screen, while leaving the centre of the picture unstretched.

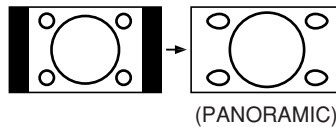

Note:

In this mode the picture is geometrically distorted on the left and the right sides of the screen.

FULL

This mode is used with 16:9 signals from a DVD or digital decoder.

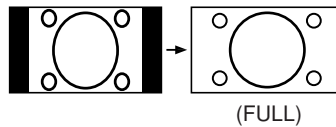

Note:

16:9 format signals can only come from external sources - the built-in tuner does not receive signals in this format.

Notes:

- In PC mode, the PICTURE SIZE feature is available only for FULL- or 4:3- format. (In "WXGA INPUT" and "WVGA INPUT"-mode, the PICTURE SIZE feature is not available.)
- In HDMI/COMPONENT1/2 mode of scanning rate: 720p and 1080i, the PICTURE SIZE feature is not available.
- In PANORAMIC mode, the top of the picture will be slightly cut off. If you want to see this part you can scroll the picture .

Scrolling the PANORAMIC-Wide picture

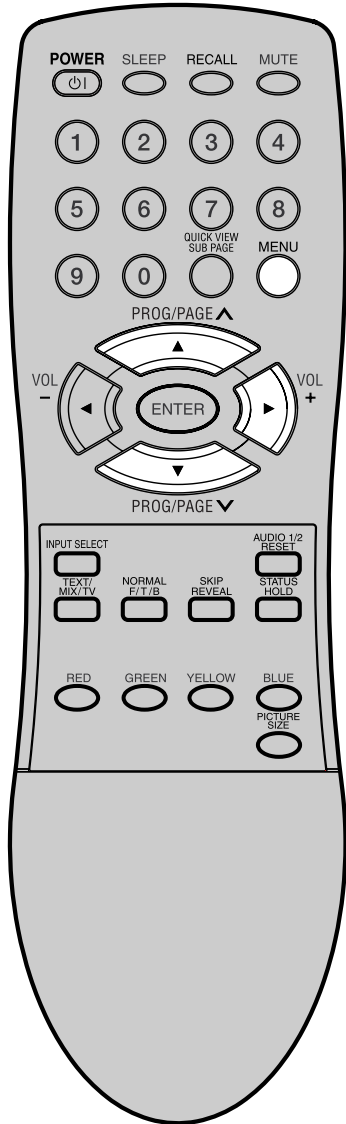



Scrolling the PANORAMIC-wide picture

During the PANORAMIC-wide mode you can adjust the vertical picture position.

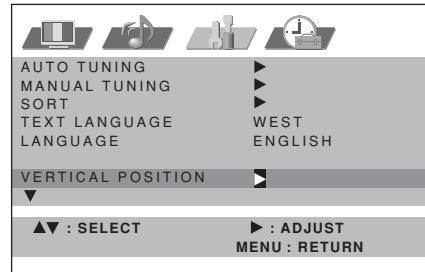
- 1 Select VERTICAL POSITION.
Then press .



- 2 Press  or  to adjust the vertical position of the picture.

• To raise the picture, press

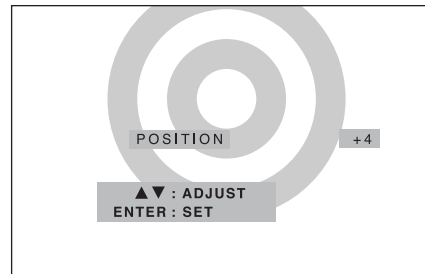

• To lower the picture, press

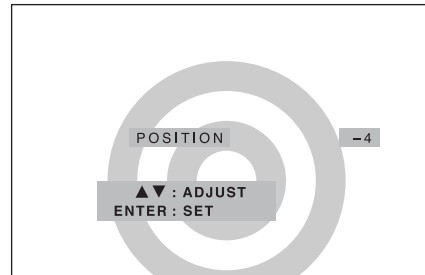

- 3 Press **MENU** repeatedly until the MENU disappears.

Note:

You cannot move the picture vertically in other wide mode.

Back light

You can use the **Back light** feature to adjust the screen brightness for improved picture clarity.

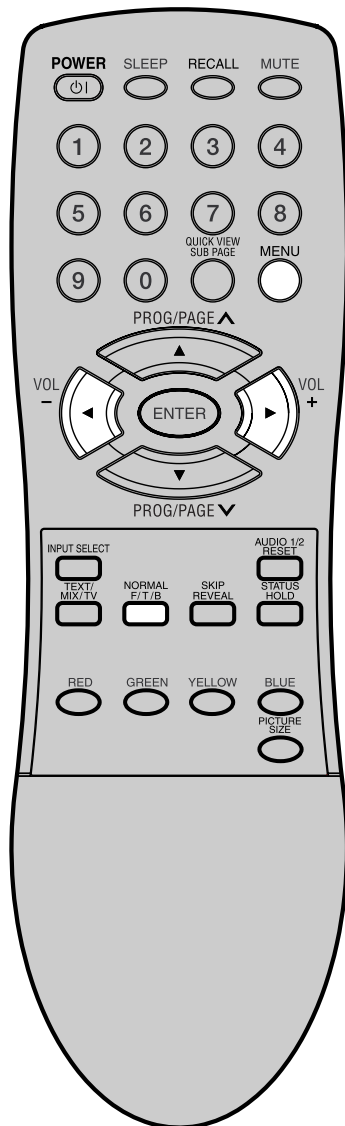

- 1 Select **BACKLIGHT**.
Then press or to adjust the level you require appears.

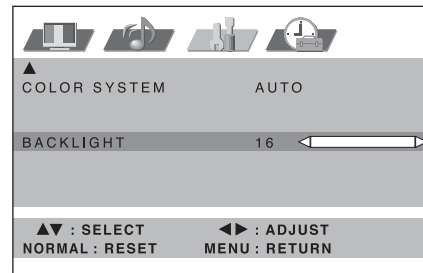

- 2 Press **MENU** repeatedly until the MENU disappears.

Note:

To initialize the adjusted value, press **NORMAL** in step 1.

Using the panel lock feature

You can lock the front panel buttons to prevent your settings from being changed accidentally (by children, for example).

When the panel lock is in ON, all control buttons on the TV front panel (except POWER) do not operate.

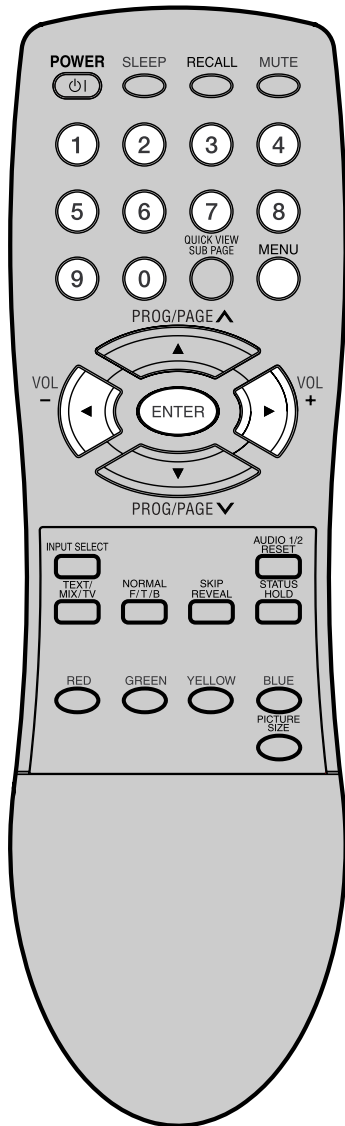

- 1 Select F.PANEL LOCK.
Then press to display the password entering screen.

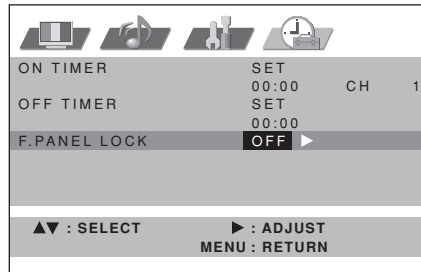

- 2 Using the **10 number buttons** to enter your password, then press **ENTER**.
The F.PANEL LOCK menu screen appears.
If you input the password for the first time, enter the same password again for confirmation.
 - If you input wrong number, "ERROR" will appear for approx. 4 seconds. Then input correct number again.

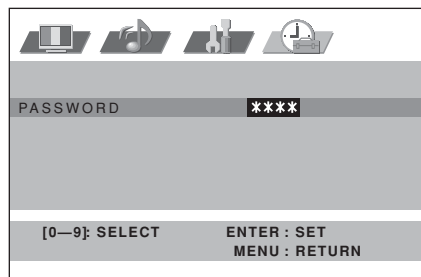

- 3 Select F.PANEL LOCK and press or to select ON.

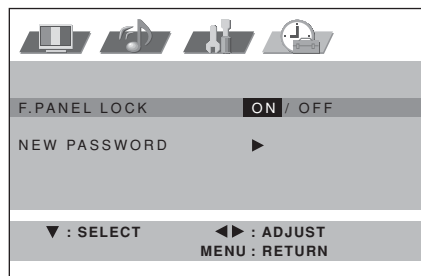

- 4 Press **MENU** repeatedly until the MENU disappears.
If a button on the front panel is pressed, the message "F.PANEL LOCK" appears for approx 4 seconds.

To unlock the panel

Select OFF at step 3 above.

To change password

At step 3 above select NEW PASSWORD and press to display the password entering screen. Then input new password.



PC-Setting

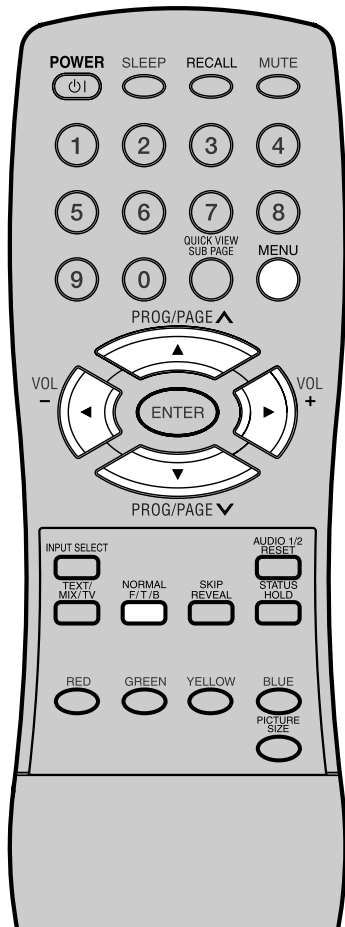

Example: Adjust the contrast.

- 1 During PC mode press **MENU** once. The Menu appears on the TV-screen.

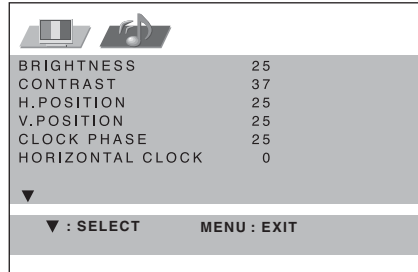

- 2 Press or to select CONTRAST. Then press or to adjust CONTRAST.

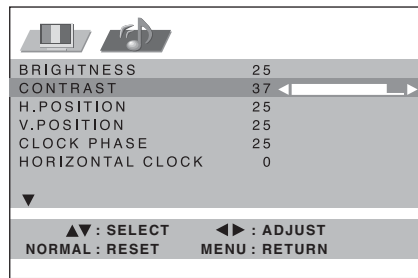

- 3 Press **MENU** repeatedly until the MENU disappears.

ENGLISH

Description about the each setting option:

PICTURE Menu

BRIGHTNESS and CONTRAST: can be set as you are accustomed to your TV. : the **NORMAL** button resets these values to the middle.

H.POSITION and V.POSITION: to adjust the horizontal and vertical placing of the image.

CLOCK PHASE and HORIZONTAL CLOCK: eliminates the horizontal (HORIZONTAL CLOCK) and vertical (CLOCK PHASE) interfering lines.

AMPLITUDE RED/GREEN/BLUE: influences the colour balance. : the **NORMAL** button resets these values to the middle.

WXGA MODE: When you input WXGA, set this option to "ON".

WVGA MODE: When you input WVGA, set this option to "ON".

AUDIO Menu

BASS/TREBLE/BALANCE: Tone setting menu; the **NORMAL** button resets these values to the middle.

PERFECT VOLUME: Select PERFECT VOLUME ON or OFF [27](#).

SPEAKERS: Select SPEAKERS ON or OFF [28](#).

HDMI: Select HDMI or DVI [36](#).

WOW SRS 3D/FOCUS/TruBass: Adjust desired WOW feature [28](#).



Note:

The PC Monitor Menu settings are not effective for normal TV-mode or external input mode.

Selecting the HDMI audio input source

You must choose an appropriate HDMI audio input setting for each connection on [16](#).

1 Select HDMI.

Press  or  to select HDMI or DVI.

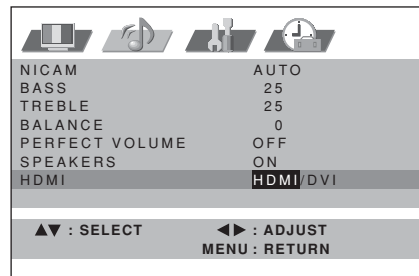
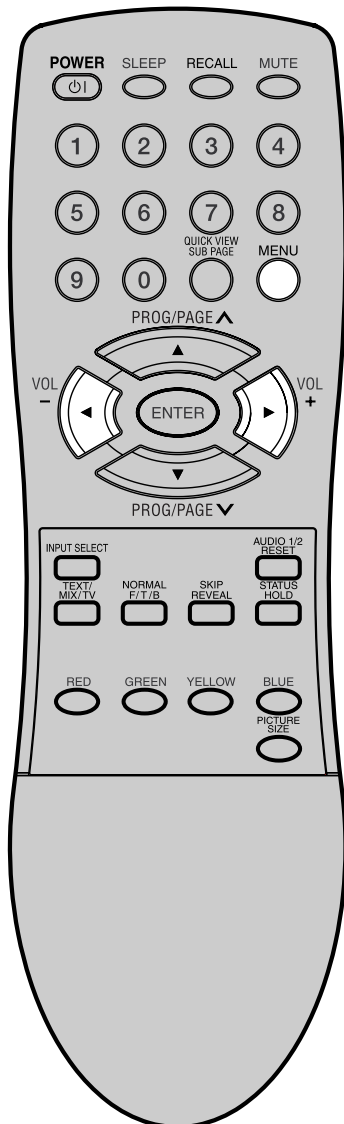

2 Press **MENU** repeatedly until the MENU disappears.



Teletext

Teletext is sent page by page. This unit is able to automatically store up to 812 pages. Storage lasts until all pages have been received. The pages can only be accessed when they have been stored. This can take a moment.

ENGLISH

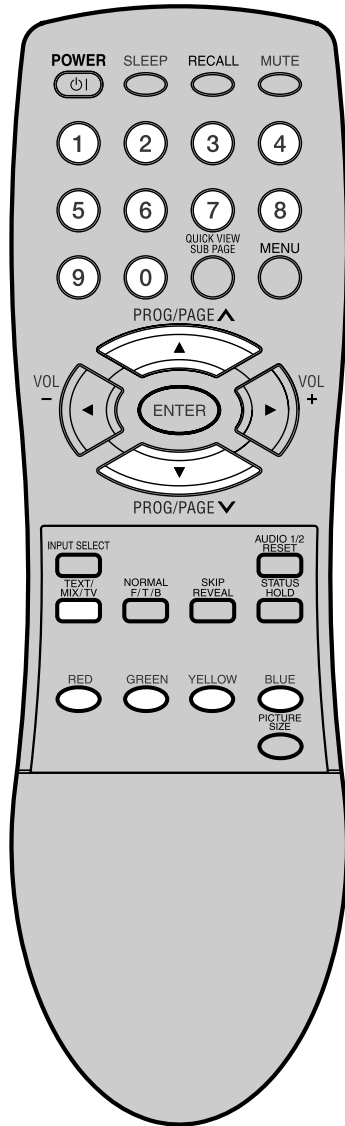

Fastext/Toptext

The Fastext/Toptext is teletext with a special directory. On the lower part of the screen there are four different coloured fields (red, green, yellow and blue). These fields lead directly to the pages shown within. The coloured buttons on the remote control correspond to the coloured fields. Press the appropriate coloured button (**RED, GREEN, YELLOW, BLUE**) in order to activate the desired colour field.



Switch on / off Teletext

Teletext is not transmitted by all channels. Select the channel that shows teletext. Press **TEXT/MIX/TV**. You will now see a teletext page. The channel you have chosen does not send teletext if 100 is shown. Press **TEXT/MIX/TV** again. Teletext and TV picture are shown simultaneously. Press **TEXT/MIX/TV** again in order to switch off teletext. Press **TEXT/MIX/TV** again in order to switch on teletext again. The last page which was stored is now shown.

Note:

You cannot select any other channels as long as teletext is switched on. Switch teletext off when you want to switch over to another channel.

Select Page

Press  or  until the page you desire appears. Or ... enter the requested page number by using the **10 Number Buttons**. And if you mistype something, just enter the complete 3-digit wrong page number then enter the desired number again. Or ... press one of the coloured teletext buttons so that a page from Fastext/Toptext is shown.



Teletext

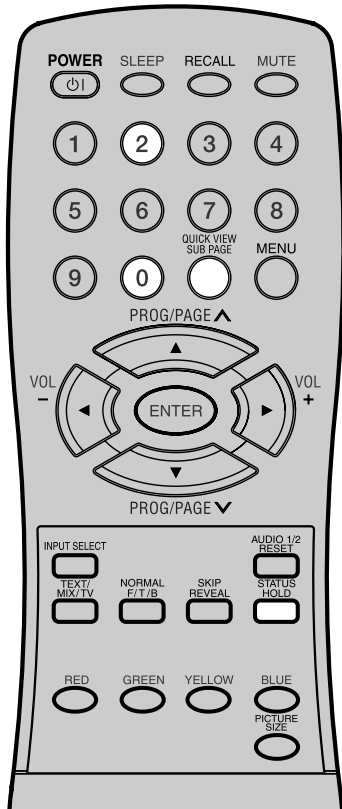

Hold Pages

Some pages are divided up into subpages by the channel. Subpages are automatically shown in turn, as they are transmitted. In order to hold the page, press **HOLD**. Press **HOLD** again in order to display the next subpage.

Directly Select Subpages

You can directly select the subpages if required.

Example:

Page 667 from BBC comprises of 2 subpages. In the right upper corner you will, for example, see 1/2. That means that page one of 2 subpages is being shown at the moment.

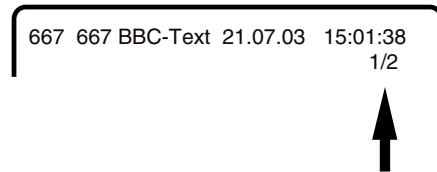

Press **SUB PAGE** in order to select subpage 2. 4 dashes (----) are shown. Enter **0 0 0 2**. It can take a minute before subpage 0002 appears.

Press **SUB PAGE** again in order to switch off the subpage feature. You can only select other teletext pages when the subpage feature is switched off.

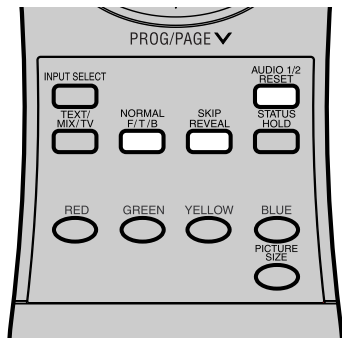

Enlargement

In order to enlarge the display, press **F/T/B**. Either the upper or lower half of the screen is enlarged. Each time you press **F/T/B** you switch between the display of the upper or lower half of the screen or the full picture.

Answering Quiz Questions



Some pages contain quiz questions with concealed answers. Press **REVEAL** in order to show the answers.

Reset

Press **RESET** in order to show page 100.

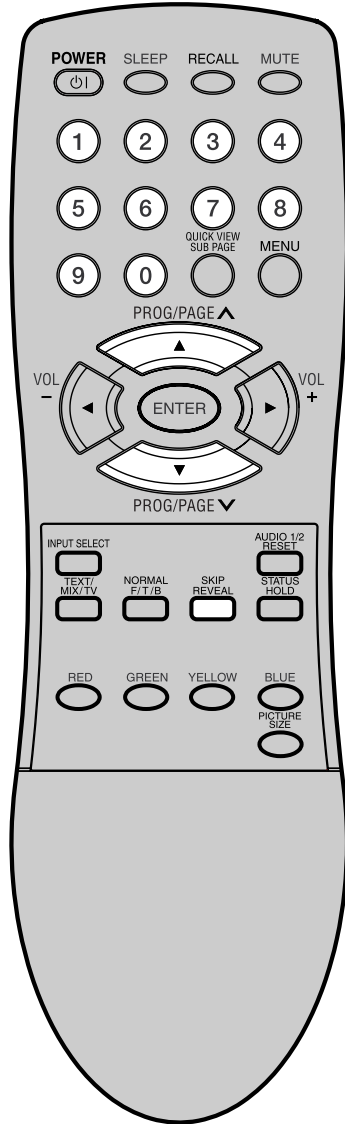
Conceal stored channels



The stored channels are switched back or fore individually using  or . Channels that should not appear can be concealed. These channels are not deleted. They can be accessed at any time with the **10 Number Buttons**.

- 1 Select the channel to be concealed (i.e. CH29).
Press **SKIP**.
The programme number flashes.

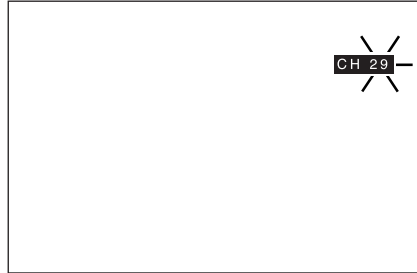

- 2 Select the next channel to be concealed.
Press **SKIP**.
The programme number flashes.

You can conceal as many channels as you like.

Example:

5 channels are automatically stored via the automatic channel storage feature. When you keep pressing  then the channel will appear in the following order:

1, 2, 3, 4, 5, 1, 2, 3, 4, 5, 1, ... etc.

Now conceal programme places 3 and 5. The sequence is now 1, 2, 4, 1, 2, 4, 1,... etc.

Cancel Concealment of Channels

Select the concealed channels with the **10 Number Buttons**.

The programme number flashes.



Press **SKIP**.

The programme number no longer flashes.



This channel is no longer concealed.

Color system adjusting

Connect with another equipment  ~ .

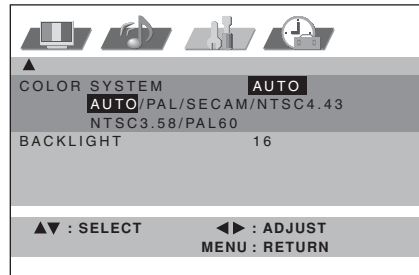
- 1 In  menu, select COLOR SYSTEM.
- 2 Press  or  to select AUTO.



- 3 If AUTO option does not work, press  or  to select desired color (e.g. NTSC 3.58).
- 4 Press **MENU** repeatedly until the menu disappears.

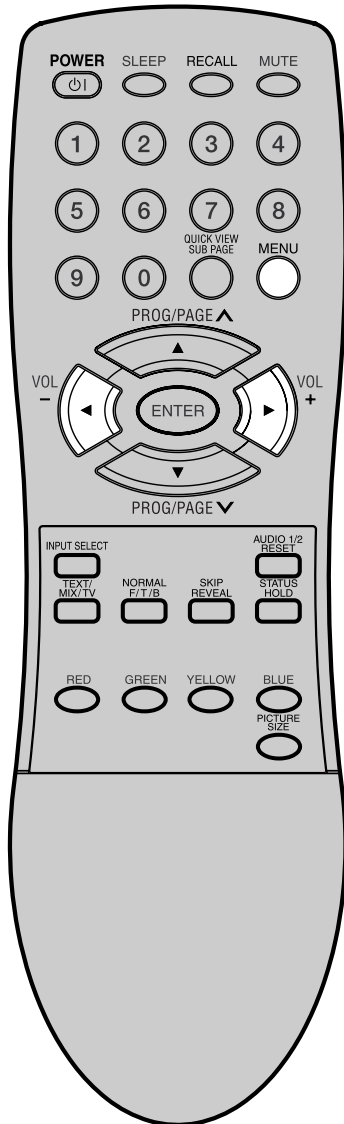

Note:

COLOR SYSTEM is available only in AV1/AV2/AV3 mode.

Troubleshooting table / Specifications

Troubleshooting table

Please check the following items, before you request for service.

Symptom	Possible solution	Page
No picture, no sound	Switch on the set. Check the 100~240 V wall outlet. Select appropriate input mode.	9 18
No reception	Preset the station without using the AV cable. Press 1 on the remote control. Connect the antenna. Check your antenna.	12 12
The TV switches off with missing antenna input signal	This is normal. 15 minutes after the antenna signal has disappeared, the set will change to standby.	23
In  menu, TUNING-line can not be selected.	The unit is set to AV mode. Press 1 on the remote control.	20
Wrong Colours	Colour and Brightness errors can occur when the viewing angle / ambient air temperature (see technical specifications) are exceeded.	

ENGLISH

Specifications

Color System:	PAL/SECAM/NTSC
Frequency Range:	1~S6, S7~S36, S37~E69
Power Supply:	AC 100~240V, 50/60Hz
Power Consumption:	Operation: approx. 170W Stand by: approx. 1W
LCD:	31.5" TYPE (80 cm visible) TFT low-glass Active Matrix Colour LCD, 1366 x 768 Pixel Brightness: 500 cd/m2 View Lange:Left/Right: 85 degree Up/Down: 85 degree
HDMI input:	HDMI compliant (type A connector) HDCP compliant Suggested scan rates: PAL: 576i/576p/720p/1080i NTSC: 480i/480p/720p/1080i HDMI Audio: 2-channel PCM 32/44.1/48 kHz sampling frequency 16/20/24 bits per sample
Output Power:	10W x 2 (MAX)
Surrounding temperature:	Operation: 5°C ~ 40°C Storage: -20°C ~ 60°C
Operating Humidity:	Less than 80%RH
Dimensions:	82.2(W) x 60.4(H) x 33.3(D) cm
Weight:	approx. 19 kg (w/o Accessories)
Accessories:	2 batteries (AAA/R03/UM-4) Remote control unit AC cord

Weight and dimensions are approximate. Because we continually strive to improve our products we may change specifications and designs without prior notice.



32LD380TA

